













2025

CATALOG ACCESORII









	ACCESORII PENTRU MAȘINI CU ACUMULATORI	3		ACCESORII PENTRU MAȘINI MULTIFUNCȚIONALE	192
	ACCESORII PENTRU PROIECTOARE ȘI LĂMPI DE LUCRU	20		ACCESORII PENTRU DEBITARE	200
	ACCESORII PENTRU INSTRUMENTE DE MĂSURAT CU LASER	23		ACCESORII PENTRU CAPSATOARE ȘI PISTOALE DE BĂTUT CUIE	230
	ACCESORII PENTRU GĂURIRE ȘI DĂLTUIRE ÎN BETON	26		ACCESORII PENTRU PISTOALE CU AER CALD	236
	ACCESORII PENTRU GĂURIRE MATERIALE MULTIPLE ȘI AMESTECARE	56		ACCESORII PENTRU ASPIRARE	241
	ACCESORII PENTRU ÎNȘURUBARE	92		ACCESORII PENTRU MAȘINI DE GRĂDINĂ	259
	ACCESORII PENTRU DEBITARE DIAMANTATĂ ȘI POLIZARE	116		ACCESORII PENTRU TRANSPORT ȘI DEPOZITARE	291
	ACCESORII PENTRU ȘLEFUIRE	156		ACCESORII DIVERSE	302
	ACCESORII PENTRU FREZARE ȘI RINDELUIRE	178		UNELTE DE MÂNĂ	306





ACCESORII PENTRU MAȘINI CU ACUMULATORI



Accesorii pentru mașini de înșurubat cu impact



	Cod	Descriere	Pentru modelul	Ambalare (buc./set)
	134745-9	Adaptor pentru cheie cu clichet 3/8" 192439-2	6940D, DTL060, DTL061, TL064D, TL065D	1
	134746-7	Adaptor pentru cheie cu clichet 1/2" 192439-2	6940D, DTL060, DTL061, TL064D, TL065D	1
	135183-8	Atașament înșurubare în unghi drept 1/4"	6940D, DTL060, DTL061, TL064D, TL065D	1
	135200-4	Atașament înșurubare în unghi drept 1/4" 25 mm	6940D, DTL060, DTL061, TL064D, TL065D	1
	135201-2	Atașament înșurubare în unghi drept 3/8"	6940D, DTL060, DTL061, TL064D, TL065D	1
	192439-2	Atașament cheie cu clichet 21 mm	6940D, DTL060, DTL061, TL064D, TL065D	1
	192440-7	Atașament înșurubare 1/4"	6940D, DTL060, DTL061, TL064D, TL065D	1

Limitatoare reglabile de adâncime

	Cod	Descriere	Pentru modelul	Ambalare (buc./set)
	194280-9	Limitator reglabil fără bit	DTD152, DTD153, DTD154, DTD155, DTD157, TD001G, TD111D	1
	194281-7	Limitator reglabil cu adaptor și bit	DTD152, DTD153, DTD154, DTD155, DTD157, TD001G, TD111D	1







Accesorii pentru mașina de înșurubat cu acumulatori WR100D







	Cod	Descriere	Prindere	Ambalare (buc./set)
	191A50-3	Adaptor 9.5	3/8"	1
	191A51-1	Adaptor 6.35	1/4"	1

Accesorii pentru pompe de vid cu acumulatori



	Cod	Descriere	Pentru modelul	Ambalare (buc./set)
	AS000VP042	Curea de umăr pentru valiza de depozitare	DVP180	1
	AS00VP050M	Ulei pentru pompa de vid (150ml)	DVP180, DVP181	1
	AS00XP808M	Manometru	DVP180, DVP181	1
	AS0AI154MK	Furtun de vid	DVP180, DVP181	1
	AS0VP007MK	Valiză depozitare din aluminiu	DVP180, DVP181	1
	AS0VP051MK	Supapă debit aer cu manometru	DVP180, DVP181	1
	AS0Y06110K	Adaptor	DVP180, DVP181	1





Accesorii pentru mașini de nituit

	Cod	Descriere	Diametru nit (mm)	Pentru modelul	Ambalare (buc./set)
	162500-9	Rezervor pop nituri	/	DRV150, DRV250	1
	199729-4	Set nituire 2,4	2,4	DRV150, DRV250	1
	199728-6	Set nituire 3,2	3,2	DRV150, DRV250	1
	191C04-2	Set nituire B 4,0	4,0	DRV150, DRV250	1
	191F80-4	Set nituire A 4.0	4.0	DRV250	1
	191C03-4	Set nituire B 4,8	4,8	DRV150, DRV250	1
	199731-7	Bacuri 4,8	4,8	DRV150, DRV250	3/1
	191F79-9	Set nituire A 4,8	4,8	DRV250	1
	199725-2	Set nituire 6,0	6,0	DRV250	1
	199730-9	Bacuri 6,4	6,4	DRV250	3/1

Accesorii pentru pistoale de etanșare cu acumulatori



	Cod	Descriere	Volum (l)	Pentru modelul	Ambalare (buc./set)
	1911M9-1	Extensie	/	CG100D, DCG180	1
	1911T4-0	Tub silicon	600 ml	CG100D, DCG180	1
	191A76-5	Set adaptor blocare	/	CG100D, DCG180	1
	1915N4-2	Set adaptor blocare	/	CG100D, DCG180	1
	191A77-3	Set adaptor unghiular	/	CG100D, DCG180	1
	191B12-7	Ansamblu cilindru gresare	/	CG100D, DCG180	1
	191F24-4	Tub de vaselină	400 g	CG100D, DCG180	1
	191W58-9	Furtun flexibil 1200 mm	/	CG100D, DCG180	1
	123221-8	Piston tip C pentru cartuş 600 ml	/	CG100D, DCG180	1
	141861-0	Tub suport cartuş 600 ml	/	CG100D, DCG180	1
	141M10-7	Tub suport cartuş 600 ml	/	CG100D, DCG180	1
	142041-1	Tijă împingere pentru cartuş 300 ml	/	CG100D, DCG180	1
	142042-9	Tijă alimentare cartuş 600 ml	/	CG100D, DCG180	1
	142071-2	Piston tip A pentru cartuşe 300 ml și 600 ml	/	CG100D, DCG180	1
	142072-0	Piston tip B pentru cartuş 600 ml	/	CG100D, DCG180	1
	191F25-2	Cartus tip B	/	CG100D, DCG180	1

	Cod	Descriere	Volum (l)	Pentru modelul	Ambalare (buc./set)
	191F27-8	Cartus tip C	/	CG100D, DCG180	1
	196351-8	Manșon suport tip A și tijă pentru pistol etanșare cu acumulatori	/	CG100D, DCG180	1
	454223-6	Inel de montare pentru cartuș 300 ml	/	CG100D, DCG180	1
	454275-7	Manșon cartuș 300 ml	0.3	CG100D, DCG180	1

Accesorii pentru mașini de legat fier beton cu acumulatori



	Cod	Descriere	Diametru (mm)	Lungime totală (mm)	Pentru modelul	Ambalare (buc./set)
	199137-9	Rolă de sârmă, 50 buc	8	100	DTR180, DTR181	50/1
	191M27-0	Braț extensie 175 mm	-	175	DTR180, DTR181	1
	162755-6	Perie de nailon	-	-	DTR180, DTR181	1



Accesorii pentru mașini de vibrat beton



	Cod	Descriere	Dimensiuni (mm)	Pentru modelul	Ambalare (buc./set)
	1910C2-9	Tijă vibrare	32 x 2.400	VR001G, VR003G, VR004G	1
	1910E2-3	Tijă vibrare	32 x 1.700	VR001G, VR003G, VR004G	1

Accesorii pentru mașini de tăiat tije filetate cu acumulatori DSC102, SC103D



	Cod	Descriere	Tipul șuruburilor	Pentru modelul	Ambalare (buc./set)
	199083-6	Set de bacuri M10	M10	DSC102, SC103D	1
	199085-2	Set de bacuri M8	M8	DSC102, SC103D	1
	199087-8	Set de bacuri M6	M6	DSC102, SC103D	1

Accesorii pentru mașina de tăiat tije filetate cu acumulatori DSC121



	Cod	Descriere	Tipul șuruburilor	Pentru modelul	Ambalare (buc./set)
	SC09002720	Bacuri M12 DSC121	M12	DSC121	1
	SC09002730	Bacuri 3/8 pentru DSC121	3/8"	DSC121	1

Accesorii pentru mașinile de tăiat fier beton DSC250 și DSC251

	Cod	Descriere	Diametru exterior (mm)	Alezaj (mm)	Număr de dinți	Pentru modelul	Ambalare (buc./set)
--	-----	-----------	------------------------	-------------	----------------	----------------	---------------------



E-11097	Disc Efficut	110	34	24	DSC250, DSC251	1
---------	--------------	-----	----	----	-------------------	---

Accesorii pentru mașina de perforat metal DPP200

	Cod	Descriere	Pentru modelul	Ambalare (buc./set)
--	-----	-----------	----------------	---------------------



SC03300790	Opritor lateral	DPP200	1
------------	-----------------	--------	---



SC03801080	Stand suport	DPP200	1
------------	--------------	--------	---

Poansoane pentru DPP200

Cod	Diametru (mm)	Oțel (65.000 psi)	Ambalare (buc./set)	Cod	Diametru (mm)	Oțel 65.000 psi)	Ambalare (buc./set)
SC05340040	6	t2-t4	1	SC05340110	13	t2-t8	1
SC05340050	6,5	t2-t6	1	SC05340120	14	t2-t8	1
SC05340060	8	t2-t6	1	SC05340130	15	t2-t8	1
SC05340070	8,5	t2-t6	1	SC05340140	16	t2-t8	1
SC05340080	10	t2-t6	1	SC05340150	18	t2-t8	1
SC05340090	11	t2-t8	1	SC05340160	20	t2-t8	1
SC05340100	12	t2-t8	1				





Lame pentru cutter cu acumulator CP100D



	Cod	Descriere	Pentru modelul	Ambalare (buc./set)
	198603-3	Lamă pentru cutter 10.8V	CP100D	1

Accesorii pentru pompe de aer cu acumulatori



	Cod	Descriere	Presiune max. (bari)	Pentru modelul	Ambalare (buc./set)
	TE00000333	Adaptor umflare perne gonflabile	0.5	MP100, DMP180, DMP181, MP001G	1
	TE00000334	Adaptor francez MP100D	7	MP100, DMP180, DMP181, MP001G	1
	TE00000691	Tijă de presiune profesională	/	MP001	1
	TE00000796	Tijă de presiune profesională	/	MP001	1







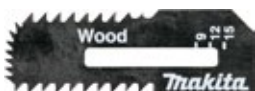

Accesorii pentru mașini de debitat deasupra capului DSD180 și SD100D

Adancimea de tăiere poate fi ajustată la grosimea plăcii de rigips.



	Cod	Lungime totală lamă (mm)	Lățime lamă (mm)	Grosime lamă (mm)	Recomandat pentru	Pentru modelul	Ambalare (buc./set)
	B-49703	55	18	0.55	plăci de rigips	DSD180, SD100D	2/1
	B-49719	55	18	0.55	lemn	DSD180, SD100D	2/1

Accesorii pentru mașini de șlefuit peretii













	Cod	Descriere	Diametru (mm)	Pentru modelul	Dimensiuni (LxIxH) (mm)	Ambalare (buc./set)
	195638-5	Geantă textilă pentru transport	/	DSL800, DSL801, DUX60, UX01G, DUX18	1.200x300x350	1
	199937-7	Set de extensii cu mâner	/	DSL800, DSL801	800	1
	199939-3	Pad moale	210	DSL800, DSL801	/	1
	199940-8	Pad mediu	210	DSL800, DSL801	/	1
	199938-5	Suport circular dur	220	DSL800, DSL801	/	1
	140J85-5	Perie tip A	/	DSL800	/	1
	140J86-3	Perie tip B	/	DSL800	/	1
	743127-0	Perie	/	DSL801	/	1

Hârtie abrazivă

Cod	Diametru (mm)	Granulație	Număr de găuri	Pentru modelul	Prindere cu scai	Ambalare (buc./set)
B-68389	225	40	9	DSL800, DSL801	•	25/1
B-68395	225	80	9	DSL800, DSL801	•	25/1
B-68404	225	120	9	DSL800, DSL801	•	25/1
E-02375	225	150	9	DSL800, DSL801	•	25/1
B-68410	225	180	9	DSL800, DSL801	•	25/1
E-02381	225	220	9	DSL800, DSL801	•	25/1
B-68426	225	320	9	DSL800, DSL801	•	25/1





Accesorii pentru mașini de polișat și șlefuit

	Cod	Descriere	Diametru (mm)	Granulație	Pentru modelul	Ambalare (buc./set)
	191N90-9	Burete polișare galben	80	/	DPV300, PV301D	1
	191N91-7	Burete polișare alb	80	/	DPV300, PV301D	1
	191N92-5	Calotă de lână	80	/	DPV300, PV301D	1
	743125-4	Pad suport 80 mm	75	/	DPV300, PV301D	1
	743124-6	Taler uport 50 mm	46	/	DPV300, PV301D	1
	743126-2	Adaptor pad 743124-6	/	/	DPV300, PV301D	1
	E-07412	Disc abraziv 50 mm A60	50	60	DPV300, PV301D	1
	E-07428	Disc abraziv 50 mm A80	50	80	DPV300, PV301D	1
	E-07434	Disc abraziv 50 mm A120	50	120	DPV300, PV301D	1
	E-07440	Disc abraziv 50 mm Z60	50	60	DPV300, PV301D	1
	E-07456	Disc abraziv 50 mm Z80	50	80	DPV300, PV301D	1

	Cod	Descriere	Diametru (mm)	Granulație	Pentru modelul	Ambalare (buc./set)
	E-07462	Disc aspru dur 50 mm	50	/	DPV300, PV301D	1
	E-07478	Disc mediu dur 50 mm	50	/	DPV300, PV301D	1
	E-07484	Disc fin dur 50 mm	50	/	DPV300, PV301D	1
	E-07490	Disc mediu moale 50 mm	50	/	DPV300, PV301D	1
	E-07509	Disc fin moale 50 mm	50	/	DPV300, PV301D	1
	E-07515	Disc foarte moale 50 mm	50	/	DPV300, PV301D	1

Accesorii pentru mașini de debitat DCC500, 4100KB



	Cod	Descriere	Pentru modelul	Ambalare (buc./set)
	126738-0	Sac aspirare praf	4100KB, DCC500	1
	191X01-4	Set alimentare apă	DCC500	1



Accesorii pentru mașina de suflat AS001G

	Cod	Descriere	Pentru modelul	Ambalare (buc./set)
	191X23-4	Duză drenare aer 7 mm	AS001G	1
	191X11-1	Duză îngustă suflare 3 mm	AS001G	1
	191X13-7	Duză curățare filtru 7 mm	AS001G	1
	191X15-3	Duză suflare 13 mm	AS001G	1
	191X17-9	Duză umflare mingi 7 mm	AS001G	1
	191X19-5	Duză suflare cu 5 găuri 6 mm	AS001G	1
	191X78-9	Duză sulfare găuri ancore	AS001G	1
	191X21-8	Duză suflare tub 6x500 mm	AS001G	1
	191X25-0	Duză cauciucată dezumflare saltele	AS001G	1
	191X27-6	Duză pentru vidare haine	AS001G	1
	191X29-2	Filtru adițional	AS001G	1

Accesorii pentru lăzi frigorifice cu funcții de răcire și încălzire





	Cod	Descriere	Pentru modelul	Ambalare (buc./set)
	WL00000313	Adaptor AC	CW002	1
	CE00000002	Husă de protecție	CW002	1
	CE00000003	Husă de protecție	CW003	1
	CE00000004	Husă de protecție	CW004	1
	CE00000001	Husă de protecție	CW001	1

Accesorii pentru fierbătoare de apă cu acumulatori

	Cod	Descriere	Pentru modelul	Ambalare (buc./set)
	KF00000076	Capac cană	KT001G, DKT360	1

Accesorii pentru aparat de făcut cafea cu acumulatori



	Cod	Descriere	Pentru modelul	Ambalare (buc./set)
	KF00000012	Cartuș cafea	DCM501	1
	KF00000014	Sertar cartuș cafea	DCM501	1
	KF00000020	Ceașcă cafea din inox	DCM501	1





ACCESORII IDEALE PENTRU MAȘINILE CU ACUMULATORI



CELE MAI BUNE REZULTATE

Obțineți cele mai bune rezultate folosind setul specializat de accesorii conceput pentru mașinile cu acumulatori.

CEA MAI BUNĂ COMPATIBILITATE

Găsiți accesoriul potrivit folosind cele 7 pictograme dedicate.







AVANTAJE

Finalizați munca mai repede și mai confortabil cu ajutorul tehnologiei acumulatorilor și autonomiei crescute.





ACCESORII PENTRU PROIECTOARE ȘI LĂMPI DE LUCRU



Becuri

	Cod	Descriere	Tensiune (V)	Pentru modelul	Ambalare (buc./set)
	192242-1	Bec	7,2 V	ML702	2/1
	192545-3	Bec	9,6 V	ML902, ML903	2/1
	A-30673	Bec	9,6-12 V	ML121	2/1
	A-83973	Bec	9,6-14,4 V	ML120, ML124, ML140, ML141, DML145	2/1
	GM00002281	Bec	9,6-14,4 V	ML120, ML124, ML140, ML141, DML145	2/1
	A-87373	Bec	14,4-18 V	DML184	2/1

Alte accesorii

	Cod	Descriere	Pentru modelul	Înălțime (mm)	Ambalare (buc./set)
	GM00001683	Conector magnetic	ML104, ML105, ML106	/	1
	GM00002073	Stand metalic	DML809, DML811	1.300 - 2.000	1
	GM00002283	Stand metalic	DML805	992 - 1.750	1
	GM00002286	Difuzor	DML809	/	1
	GM00002287	Difuzor	DML811	/	1

	Cod	Descriere	Pentru modelul	Înălțime (mm)	Ambalare (buc./set)
	GM00002358	Difuzor	ML005	/	1
	GM00002359	Film anti-strălucire	ML005	/	1
	GM00002377	Difuzor	ML009	/	1
	GM00002378	Trepied	ML009	/	1



ACCESORII PENTRU INSTRUMENTE DE MĂSURAT CU LASER













Trepiede

	Cod	Descriere	Filet de prindere	Înălțime (mm)	Ambalare (buc./set)
	P-81088	Trepied de aluminiu standard	5/8	440-1650	1
	TK0LM2000F	Trepied mic din aluminiu	5/8	400-1100	1
	TK0LM4001F	Trepied din aluminiu	5/8	680-1800	1
	TK0LM5030F	Trepied din aluminiu	5/8	780-2900	1



Alte accesorii

	Cod	Descriere	Pentru modelul	Ambalare (buc./set)
	199010-3	Cablu USB	SK312GD, SK209GD	1
	199178-5	Cablu USB	SK105, SK106	1
	LE00785640	Detector	SK102Z, SK103PZ, SK104Z	1
	LE00855702	Detector fascicule laser	SK103,SK104,SK105,SK106	1
	LE00870137	Suport de perete pentru instrumente laser	SK103, SK104, SK105, SK106	1
	TK000ET03F	Suport de perete pentru instrumente laser	SK312GD, SK209GD	1
	TK0LDG301G	Receptor LDG-3 pentru instrumente laser	SK312GD, SK209GD	1
	TK0LEG2000	Ochelari pentru o mai bună vizualizare a liniei laser	LD050P, LD080P, LD100P, SK102Z, SKR200Z, 103PZ, SK104Z	1
	CP00000001	Adaptor ADP09 CXT pentru baterii (8 x AA)	SK40GD, SK20GD, SK10GD, SK700GD, SK700D, SK312GD	11
	TK0LDG501G	Receptor laser	SK10GD	

ACCESORII PENTRU GĂURIRE ȘI DĂLTUIRE ÎN BETON

SDS-PLUS



SDS-MAX



Prindere Hex 13 mm



Prindere Hex 17 mm



Prindere Hex 19 mm



Prindere Hex 21 mm



Prindere Hex 28,6 mm



Prindere Hex 30 mm



Beton armat



Beton



Cărămidă



Metal



Gheață



Pentru găurire uscată



Extragerea prafului





COMPARAȚIE ACCESORII SDS-Plus

BURGHIU	STANDARD	CU VÂRF DE CENTRARE	STANDARD 4	V-PLUS	NEMESIS II
Clasa de calitate	★★	★★★	★★★★	★★★★★	★★★★★★
Vârf din carbură monobloc					
Vârf	Vârf cu 2 muchii de tăiere	Vârf de centrare cu 2 muchii de tăiere	Vârf de centrare cu 4 muchii de tăiere	Vârf de centrare crestă cu 2 muchii de tăiere	Vârf de centrare simetric cu 4 muchii de tăiere
Spirală	2 caneluri	2 caneluri	2 caneluri	2 caneluri durabilitate crescută	4 caneluri durabilitate crescută
Diametru (ø)	3,5-30 mm	4-32 mm	5-25 mm	5-26 mm	5-32 mm
Viteză					
Durăta de viață					
Poziționare ușoară					
Precizie					
Drenarea deșeurilor de beton armat					
Material					



COMPARAȚIE ACCESORII SDS-Max



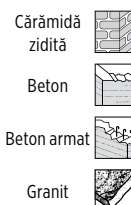









BURGHIU	STANDARD	MAK4	MINERIT
Clasa de calitate	★★	★★★★	SPECIALIZED
Vârf din carbură monobloc			
Vârf	Vârf cu 2 tăişuri	Vârf de centrare cu 4 tăişuri	Vârf cu 4 tăişuri
Spirală	2 caneluri	4 caneluri-înaltă durabilitate	2 caneluri-înaltă durabilitate
Diametru (ø)	12-40 mm	12-52 mm	28-32 mm
Viteză			SPECIALIZED
Durăta de viață			
Poziționare ușoară			
Precizie			
Drenarea deșeurilor de beton armat			
Material			

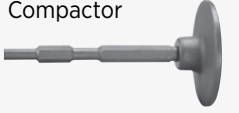

METODE DE FIXARE PENTRU BURGHIE ȘI DĂLȚI

PRINDERE		MODEL COMPATIBIL	
SDS-Plus		Mașini cu mandrină SDS-Plus	
SDS-MAX		Mașini cu mandrină SDS-Max	
Hex 13 mm, 4 lame		8035NB/HR3510/HR3520/HR3850	
Hex 17 mm		HM0810T	
Hex 19 mm, Tip K		HM1200K/HR3850K/HR500K	
Hex 19 mm, Tip B		HM1200B	
Hex 19 mm, Tip B		HM0810B	
Hex 19 mm		HK1800/HK1810	
Hex 21 mm		HM1200	
Hex 28,6 mm, Tip B		HM1812/HM1810/HM1802/HM1801/HM1800/ HM1307CB/HM1304B/HM1303B	
Hex 30 mm		HM1317C/HM1307C/HM1304/HM1300	
Hex 30 mm		HM1400 (clemă rotativă pentru 90°)	



SDS -Plus	SDS -Max	17 mm Hex	19 mm Hex	21 mm Hex	28,6 mm Hex	30 mm Hex	UTILIZARE	FORMĂ
	•				•	•	Demolări și ajustări în piatră și beton.	Șpiț cu autoascuțire 
•	•	•	•	•	•	•	Demolări și ajustări în piatră și beton.	Daltă șpiț 
•	•	•	•	•	•	•	Demolări și ajustări în tencuială și beton. Sfărâmare, spargere și canelare în tencuială, piatră și beton.	Daltă plată 
•	•	•	•				Tăiere de canale în beton.	Daltă scoabă 
•	•	•	•	•	•	•	Îndepărtarea de resturi de beton.	Daltă lată 
	•	•				•	Săpare în argilă, pietriș dur, pietriș compact sau pământ.	Daltă sapă 
		•			•	•	Compactarea asfaltului, a pietrișului, pământului sau noroiului.	Compactor 
	•	•	•				Buciardarea betonului sau a asfaltului.	Buciardă 
•							Îndepărtarea adezivilor și curățarea suprafețelor.	Răzuitor 
•	•						Prelucrarea cărămizilor și a calcarului. Ideal pentru controlul adâncimii cu ajutorul aripilor.	Daltă scoabă cu aripi 
•	•						Îndepărtarea plăcilor de faianță.	Daltă îndepărtare faianță 
	•						Îndepărtarea straturilor de tencuială și a urmelor de beton dintre faianță și zid.	Daltă articulară 
•							Daltă specială pentru prelucrarea lemnului.	Daltă prelucrare lemn 

NEMESIS II



BURGHIE SDS-Plus NEMESIS II



Armătură

Armăturile laterale ale burghiului asigură o utilizare sigură și rezistență ridicată la deformare.



Canelură simetrică

4 spirale simetrice pentru drenarea uniformă a materialului găurit.



Spirală rigidă

Spirala rigidă reduce șocul și oferă o rezistență mărită la fisuri.

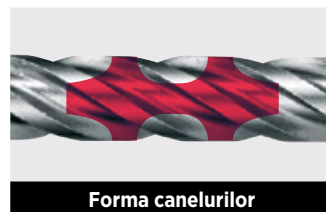

Forma canelurilor

Forma îmbunătățită a canelurilor asigură drenarea rapidă a materialului găurit.



Indicator de uzură

Indicator de uzură al burghiului.



Margini șanfrenate

Marginile șanfrenate mărite reduc riscul de blocare.



Durată de viață

Durată de viață extinsă față de burghiele standard.



5-10 mm Ø

Vârful de centrare solid permite găurirea exact în locul marcat.



12-16 mm Ø

Vârful din carbură monobloc oferă performanțe în găurirea betonului armat.



18-32 mm Ø

Vârful din carbură din trei părți permite găurirea facilă a armăturilor din fier beton.



BURGHIE cu două muchii de tăiere SDS-Plus V-PLUS

Geometria conică a spiralei asigură o viteză de găurire mai mare și durabilitate remarcabilă.



Spirală conică

Forma spiralată reduce rezistența la frecare și îndepărtează eficient resturile pentru o găurire rapidă.



Muchii de tăiere zimțate

Produc microfisuri în materialul prelucrat, pentru o găurire mai rapidă.



Vârf de centrare îmbunătățit

Asigură o găurire de precizie și previne alunecarea pe suprafețe netede.



Margini șanfrenate

Marginile șanfrenate reduc riscul blocării burghiului în armăturile din fier beton.

ACCESORII PENTRU CIOCANE ȘI DEMOLATOARE CU MANDRINĂ SDS-PLUS
Burghie SDS-Plus Nemesis II

Găurirea în beton armat nu mai este atât de dificilă, bările de armatură nu mai reprezintă un obstacol pentru burghiile Nemesis II. Nemesis II este excelent pentru găurirea în cea mai dură piatră naturală. Forma simetrică a varfului burghiului asigură o găurire precisă, în plus este excelent pentru executarea găurilor de ancorare în care este necesară o precizie ridicată. Cu un burghiu Nemesis II puteți face cu 50% mai multe găuri comparat cu burghiile convenționale.



Cod	Diametru (Ø) (mm)	Lungime totală (mm)	Lungime de lucru (mm)	Ambalare (buc./set)
B-57934	3	315	250	1
B-57897	5	110	50	1
B-57906	5	165	100	1
B-57928	5	265	200	1
B-57962	6	115	50	1
B-57978	6	165	100	1
B-58827	6	165	100	5
B-63264	6	165	100	10
B-57984	6	215	150	1
B-57990	6	265	200	1
B-58001	6	315	250	1
B-58023	6,5	165	100	1
B-58045	6,5	265	200	1
B-58051	6,5	315	250	1
B-58067	7	115	50	1
B-58073	7	165	100	1
B-58095	8	115	50	1
B-58104	8	165	100	1
B-58110	8	215	150	1
B-58908	8	215	150	5
B-58126	8	265	200	1
B-58132	8	315	250	1
B-58154	8	465	300	1
B-19869	9	160	100	1
B-58176	9	165	100	1
B-58198	10	115	50	1
B-58207	10	165	100	1
B-58213	10	215	150	1
B-58229	10	265	200	1
B-58235	10	315	250	1
B-58257	10	455	390	1
B-58263	10	600	540	1
B-58279	10	1.000	940	1
E-14532	12	160	110	1
B-58338	12	210	150	1
E-14548	12	210	150	1
B-58344	12	260	210	1
E-14554	12	260	210	1

Cod	Diametru (Ø) (mm)	Lungime totală (mm)	Lungime de lucru (mm)	Ambalare (buc./set)
E-14560	12	310	260	1
B-58366	12	450	400	1
E-14576	12	450	400	1
E-14582	12	600	540	1
B-58431	14	160	110	1
E-14635	14	160	110	1
B-58447	14	210	160	1
E-14641	14	210	160	1
B-58453	14	260	210	1
E-14657	14	260	210	1
B-58469	14	310	260	1
E-14663	14	310	260	1
B-58475	14	450	400	1
E-14679	14	450	400	1
B-58481	14	600	550	1
E-14685	14	600	550	1
B-58497	14	1.000	950	1
E-19607	14	1.000	950	1
B-14211	15	210	150	1
B-58512	15	210	150	1
B-58540	16	160	110	1
E-14738	16	160	110	1
B-58556	16	210	160	1
E-14744	16	210	160	1
B-58562	16	260	210	1
E-14750	16	260	210	1
B-58578	16	310	260	1
E-14766	16	310	260	1
B-58584	16	450	400	1
E-14772	16	450	400	1
B-58590	16	600	550	1
E-14788	16	600	550	1
B-58609	16	1.000	950	1
E-19613	16	1.000	950	1
B-58615	18	250	200	1
B-58621	18	450	400	1
B-58637	20	250	200	1
B-58659	20	450	400	1
B-58665	22	250	200	1
B-58687	22	450	400	1
B-58702	24	450	400	1
B-58718	25	250	200	1
B-58724	25	450	400	1
B-58746	28	250	200	1
B-58752	28	450	400	1
B-58768	30	250	200	1
B-58774	30	450	400	1
B-58780	32	450	400	1

Burghie SDS-Plus V-Plus

Burghiile V-Plus stabilesc noi standarde de performanță. Geometria conică a spiralei permite o viteză de găurire mai mare și o rezistență excepțională. Aceste burghie sunt excelente pentru utilizarea cu mașini cu acumulatori.



Cod	Diametru (Ø) (mm)	Lungime totală (mm)	Lungime de lucru (mm)	Ambalare (buc./set)
B-46492	5	110	50	1
B-46501	5	160	100	1
B-60408	5	450	390	1
E-22632	5,5	460	410	1
B-46517	6	110	50	1
B-46523	6	160	100	1
B-47341	6	210	150	1
B-47357	6	260	200	1
B-47400	6,5	210	150	1
B-47416	6,5	260	200	1
B-47422	6,5	310	250	1
B-47438	7	110	50	1
B-47444	7	160	100	1
B-46539	8	110	50	1
B-46545	8	160	100	1
B-47472	8	210	150	1
B-47488	8	260	200	1
B-47503	8	400	340	1
B-47525	8	600	550	1
B-47531	9	160	100	1
B-47547	9	210	150	1
B-46551	10	110	50	1
P-29418	10	110	50	1
B-46567	10	160	100	1
B-47569	10	210	150	1
B-47575	10	260	200	1
B-47581	10	310	250	1
B-47606	10	450	400	1
B-47612	10	600	540	1
B-47634	10	1000	950	1
B-47662	11	260	200	1
B-46573	12	160	100	1
B-47684	12	210	150	1
B-47690	12	260	200	1
B-47715	12	360	310	1
B-47721	12	450	400	1
B-47737	12	600	550	1
B-47759	12	1000	950	1
B-46589	14	160	100	1
B-47802	14	210	150	1
B-47818	14	260	200	1
B-47830	14	450	400	1
B-47846	14	600	550	1

Cod	Diametru (Ø) (mm)	Lungime totală (mm)	Lungime de lucru (mm)	Ambalare (buc./set)
B-47852	14	1000	950	1
B-47868	15	160	100	1
B-47880	15	260	200	1
B-47896	15	450	390	1
B-47905	16	160	100	1
B-47911	16	210	150	1
B-47927	16	260	200	1
B-47933	16	310	250	1
B-47949	16	450	400	1
B-47961	16	800	750	1
B-47977	16	1000	950	1
B-48000	18	200	150	1
B-48016	18	300	250	1
P-02652	18	300	250	1
B-48022	18	450	400	1
B-48038	18	600	550	1
B-48044	18	1000	950	1
B-48066	19	450	390	1
B-48072	20	200	150	1
B-48088	20	300	250	1
B-48094	20	450	400	1
B-48103	20	600	550	1
B-48125	20	1000	950	1
B-48131	22	250	200	1
B-48147	22	450	400	1
B-48169	22	1000	950	1
B-48175	23	250	200	1
B-48197	24	250	200	1
B-48206	24	450	400	1
B-48228	25	450	400	1
B-48234	25	450	400	1
B-48262	26	250	200	1
B-48278	26	450	400	1
B-49105	Set 12 burghie SDS-Plus V-Plus			1

Burghie SDS-Plus P2S



Cod	Diametru (Ø) (mm)	Lungime totală (mm)	Lungime de lucru (mm)	Ambalare (buc./set)
P-02646	18	200	-	1
P-14364	18	1000	-	1
P-14370	20	1000	-	1
P-26107	22	1000	-	1

Burghie SDS-Plus cu vârf de centrare

Cod	Diametru (Ø) (mm)	Lungime totală (mm)	Lungime de lucru (mm)	Ambalare (buc./set)
B-54156	6	160	100	1
B-54162	6	210	150	1
B-54178	8	110	50	1
B-54184	8	160	100	1
B-54190	10	160	100	1
B-54209	10	210	150	1
B-54215	12	160	100	1
B-54221	12	210	150	1
B-55859	4	110	50	1
B-55865	5,5	110	50	1
B-55871	5,5	160	100	1
B-55887	6,5	110	50	1
B-55893	6,6	160	100	1
B-55902	6,7	210	150	1
B-55918	6,8	260	200	1
B-55924	7	110	50	1
B-55930	7	160	100	1
B-55946	7	210	150	1
B-55952	8	210	150	1
B-55968	8	260	200	1
B-55974	9	160	100	1
B-55980	10	110	50	1
B-55996	10	260	200	1
B-56007	10	310	250	1
B-56013	10	450	390	1
B-56029	12	260	200	1
B-56035	12	350	290	1
B-56041	12	450	390	1
B-56057	13	160	100	1
B-56063	14	160	100	1
B-56079	14	210	150	1
B-56085	14	260	200	1
B-56091	14	350	290	1
B-56100	14	450	390	1
B-56116	16	160	100	1
B-56122	16	210	150	1
B-56138	16	310	250	1
B-56144	16	350	290	1
B-56150	16	450	390	1
B-56465	17	210	150	1
B-56471	17	350	290	1

Burghie SDS-Plus cu 4 muchii de tăiere

Vârful de precizie cu 4 pastile din carbură previne blocarea burghiului în bările de armătură. Aceste burghie creează găuri precise și uniforme. Sunt potrivite pentru găurirea în beton armat.



Cod	Diametru (Ø) (mm)	Lungime totală (mm)	Lungime de lucru (mm)	Ambalare (buc./set)
B-62496	6	110	50	1
B-62505	6	160	100	1
B-62511	6	210	150	1
B-62692	6	260	200	1
B-62549	6,5	160	100	1
B-62555	6,5	210	150	1
B-62561	6,5	260	200	1
B-62608	8	110	50	1
B-62614	8	160	100	1
B-62620	8	210	150	1
B-62636	8	260	200	1
B-62642	8	310	250	1
B-62658	8	460	400	1
B-62664	10	110	50	1
B-62670	10	160	100	1
B-62686	10	210	150	1
B-62692	10	260	200	1
B-62701	10	310	250	1
B-62717	10	350	290	1
B-62723	10	460	400	1
B-62739	12	160	100	1
B-62745	12	210	150	1
B-62751	12	260	200	1
B-62767	12	310	250	1
B-62773	12	350	290	1
B-62789	12	460	400	1
B-62795	14	160	100	1
B-62804	14	210	150	1
B-62810	14	260	200	1
B-62826	14	310	250	1
B-62832	14	350	290	1
B-62848	14	460	400	1
B-62854	16	160	100	1
B-62860	16	210	150	1
B-62876	16	260	200	1
B-62882	16	310	250	1
B-62898	16	350	290	1
B-62907	16	460	400	1

Burghie SDS-Plus standard

Burghie SDS-Plus standard sunt ideale pentru găurire în zidărie și beton. Vârful de carbură de înaltă calitate cu două tăişuri și cele două caneluri optimizate pentru extragerea prafului permit viteze mai mari de forare. Vârful TCT este fabricat în conformitate cu standardul DIN 8039 și este disponibil la diametre cuprinse între 3,5 și 30 mm.



Cod	Diametru (Ø) (mm)	Lungime totală (mm)	Lungime de lucru (mm)	Ambalare (buc./set)
D-00016	4	110	50	1
D-00022	5	110	50	1

Cod	Diametru (Ø) (mm)	Lungime totală (mm)	Lungime de lucru (mm)	Ambalare (buc./set)
D-00038	5	160	100	1
D-00044	5,5	110	50	1
D-00050	6	110	50	1
D-00066	6	160	100	1
D-00072	6	210	150	1
D-00088	6,5	110	50	1
D-00094	6,5	160	100	1
D-00103	7	110	50	1
D-00119	7	160	100	1
D-00125	8	110	50	1
D-00131	8	160	100	1
D-00147	8	210	150	1
D-00153	8	260	200	1
D-00169	9	210	150	1
D-00175	10	160	100	1
D-00181	10	210	150	1
D-00197	10	260	200	1
D-00206	10	310	250	1
D-17538	10	460	400	1
D-00212	11	160	100	1
D-00608	11	160	100	1
D-00228	12	160	100	1
D-00234	12	210	150	1
D-00240	12	260	200	1
D-16271	12	460	400	1
D-00256	13	160	100	1
D-00262	14	160	100	1
D-00278	14	260	200	1
D-17544	14	460	400	1
D-00284	15	160	100	1
D-17550	15	460	400	1
D-00290	16	210	150	1
D-00309	16	310	250	1
D-16287	16	460	400	1
D-00315	17	210	150	1
D-00321	18	210	150	1
D-00337	18	300	240	1
D-17566	18	460	400	1
D-00343	19	210	150	1
D-16293	19	460	400	1
D-00359	20	210	150	1
D-00365	20	310	250	1
D-15235	20	460	400	1
D-00371	22	260	200	1
D-08062	22	310	250	1
D-15241	22	460	400	1
D-16302	24	460	400	1
D-00387	25	260	200	1
D-08517	25	310	250	1
D-15257	25	460	400	1
D-00393	26	260	200	1
D-08078	26	310	250	1
D-15263	26	460	400	1
D-16318	28	460	400	1
D-17572	30	460	400	1

SISTEM DE ASPIRARE INOVATOR

Noua serie de burghie de aspirație



Compatibil cu tubul
Ø28 mm

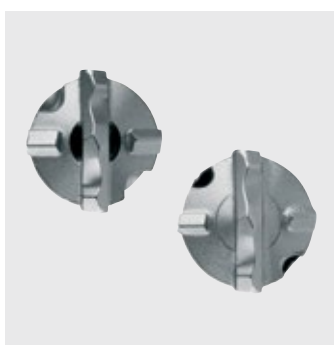

VÂRF DIN 3 PĂRȚI

Vârful din 3 părți permite burghiului găurirea facilă a armăturilor din fier beton.



BURGHIU - ASPIRATOR

Compatibil cu majoritatea sistemelor de aspirație.



VERSATILITATE

Burghiele cu conexiune la aspirație sunt disponibile cu prindere SDS-Plus și SDS-Max.



Pentru a lucra în condiții de siguranță, țineți cu mâna furtunul conectat, pentru a preveni rotirea simultană cu burghiul.

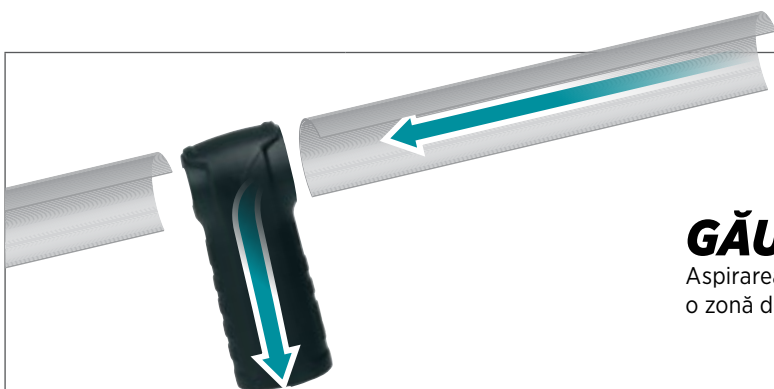

GĂURIRE FĂRĂ PRAF

Aspirarea eficientă a prafului prin vârful burghiului asigură o zonă de lucru curată. Potrivit pentru beton și beton armat.

SDS-MAX

Model	Diametru	Lungime	Lungime activă	Model	Diametru	Lungime	Lungime activă
B-64428	16 mm	600 mm	400 mm	B-64490	28 mm	900 mm	700 mm
B-64434	18 mm	600 mm	400 mm	B-64509	30 mm	600 mm	400 mm
B-64440	20 mm	600 mm	400 mm	B-64515	30 mm	900 mm	700 mm
B-64456	22 mm	600 mm	400 mm	B-64537	32 mm	900 mm	700 mm
B-64462	24 mm	600 mm	400 mm	B-64521	32 mm	600 mm	400 mm
B-64478	25 mm	600 mm	400 mm	B-64543	35 mm	600 mm	400 mm
B-64484	28 mm	600 mm	400 mm	B-64559	35 mm	900 mm	700 mm

SDS-PLUS

Model	Diametru	Lungime	Lungime activă
B-64381	12 mm	200 mm	325 mm
B-64397	14 mm	240 mm	360 mm
B-64406	16 mm	240 mm	360 mm
B-64412	18 mm	240 mm	360 mm

Burghie extracție praf SDS-Plus

Burghiile cu extracție a prafului sunt ideale pentru găurirea betonului armat, asigurând o găurire curată și sunt compatibile cu aspiratoarele cu furtun de conectare cu diametrul de 28 mm. Conexiunea la alte aspiratoare se face cu ușurință folosind cuplajul de 24 (195546-0) pentru aspiratoarele: VC3211H/M, VC2211M, DVC350, DVC860L, DVC862L, DVC260. Utilizați adaptorul 24 (P-81745) pentru VC2012L, VC2512L, VC3011L și adaptorul 24 (P-70378) pentru VC3012L.



Cod	Diametru (Ø) (mm)	Lungime totală (mm)	Lungime de lucru (mm)	Ambalare (buc./set)
B-64381	12	325	200	1
B-64397	14	360	240	1
B-64406	16	360	240	1
B-64412	18	360	240	1

Burghie SDS-Plus pentru lemn



Cod	Diametru (Ø) (mm)	Lungime totală (mm)	Ambalare (buc./set)
B-57489	4	105	1
B-57495	5	116	1
B-57504	6	123	1
B-57510	8	147	1
B-57526	10	163	1

Burghie SDS-Plus pentru metal



Cod	Diametru (Ø) (mm)	Lungime totală (mm)	Ambalare (buc./set)
B-57401	3	90	1
B-57417	3,5	100	1
B-57423	4	105	1
B-57439	4,5	110	1
B-57445	5	123	1
B-57451	5,5	123	1
B-57467	6	123	1
B-57473	6,5	131	1

Carote SDS-Plus

Carotele SDS-Plus sunt potrivite pentru electricieni, instalatori, dulgheri și alți utilizatori în construcții generale. Puteți folosi carotele în mai multe materiale precum cărămidă, plăci de rigips, materiale plastice, placaj, lemn și PAL. Obțineți rezultate excelente cu ajutorul dinților TCT.



	Cod	Descriere	Lățime (mm)	Lungime totală (mm)	Adâncime găurire (mm)	Ambalare (buc./set)
	P-26191	Carotă TCT SDS-Plus	40	80	60	1
	P-26200	Carotă TCT SDS-Plus	50	80	60	1
	P-26216	Carotă TCT SDS-Plus	65	72	60	1
	P-26222	Carotă TCT SDS-Plus	80	72	60	1
	P-64347	Burghiu de centrare	8	120	80	1
	P-67745	Adaptor carotă SDS-Plus / M16	/	105	/	1

Mandrine și adaptoare SDS-Plus



	Cod	Descriere	Compatibil cu	Ambalare (buc./set)
	122574-2	Adaptor SDS-Plus mandrină cu cheie	SDS-Plus	1
	125420-8	Cap mandrină SDS-Plus	HR3210FCT	1
	122823-7	Mandrină rapidă SDS-Plus	SDS-Plus	1
	194079-2	Mandrină cu strângere rapidă	HR2450T, HR2470T, HR2630T, HR2810T, HR2811FT, BHR261T, BHR243, HR2610T, HR2611FT, DHR243, DHR264, BHR262T, HR2631F	1
	194080-7	Mandrină rapidă SDS-Plus	HR2450T, HR2470T, HR2810T, HR2811FT, BHR261T, BHR243, HR2610T, HR2611FT, DHR243, DHR264, BHR262,T, HR2300T, HR2631F, HR2630T	1
	B-57548	Adaptor înșurubare SDS-Plus la 1/4"	SDS-Plus	1
	D-14093	Adaptor SDS-Plus la 1/2"-20 UNF	HR2455	1
	P-21646	Adaptor SDS-Plus la 1/4", 78 mm	HR2010,HR2020, HR2230, HR2432, HR2440, HR2450T, HR2450FT, HR2460, HR2470T,HR2470FT, HR2810, HR2811FT, HR3000, HR3200, HR3200C, HR3210C, HR3210TCT	1

ACCESORII PENTRU ROTOPERCUTOARE ȘI DEMOLATOARE SDS-MAX
Burghie SDS-Max MAK4

Burghie premium SDS-Max cu vârf cu 4 tășuri în formă dinamică. Designul simetric al capului cu vârful de centrare oferă rezultate optime în contactul cu armătura. Canelurile scurtate cu formă conică pentru îndepărtarea prafului permit extragerea rapidă a prafului datorită volumului dublu al canelurii. Burghiile MAK4 au o viteză mare de găurire și o durată de viață prelungită. Burghiile cu diametre cuprinse între 12-15 mm au două caneluri.



Cod	Diametru (Ø) (mm)	Lungime totală (mm)	Lungime de lucru (mm)	Ambalare (buc./set)
P-17033	12	340	200	1
P-17049	12	540	400	1
P-17055	12	690	500	1
P-17077	14	340	200	1
P-17083	14	540	400	1
P-17108	15	340	200	1
P-17114	15	540	400	1
P-77730	16	340	200	1
P-77746	16	540	400	1
P-77752	16	940	800	1
P-77774	18	340	200	1
P-77780	18	540	400	1
P-77796	18	940	800	1
P-77805	18	1320	1180	1
P-77811	20	320	200	1
P-77827	20	520	400	1
P-77833	20	920	800	1
P-77855	22	320	200	1
P-77861	22	520	400	1
P-77883	22	1320	1200	1
P-77899	24	320	200	1
P-77908	24	520	400	1
P-77914	25	320	200	1
P-77920	25	520	400	1
P-77936	25	920	800	1
P-77942	25	1320	1180	1
P-77958	26	520	400	1
P-77964	28	370	250	1
P-77970	28	570	450	1
P-77986	28	670	550	1
P-77992	28	920	800	1
P-78003	28	1320	1200	1
P-78019	30	370	250	1
P-78025	30	570	450	1
P-78031	32	370	250	1
P-78047	32	570	450	1
P-78053	32	920	800	1
P-78069	32	1320	1180	1
P-78075	35	370	250	1

Cod	Diametru (Ø) (mm)	Lungime totală (mm)	Lungime de lucru (mm)	Ambalare (buc./set)
P-78081	35	570	450	1
P-17398	35	670	550	1
P-78097	35	670	550	1
P-78592	35	1320	1200	1
P-78112	37	570	450	1
P-78128	37	920	800	1
P-78134	38	370	250	1
P-17413	38	570	450	1
P-78140	38	570	450	1
P-17429	40	370	250	1
P-78156	40	370	250	1
P-78162	40	570	450	1
P-78178	40	920	800	1
P-78184	40	1320	1200	1
P-78190	45	570	450	1
P-78209	45	920	800	1
P-78215	50	570	450	1
P-78221	52	570	450	1

Burghie SDS-MAX TCT cu 4 tășuri



Cod	Diametru (Ø) (mm)	Lungime totală (mm)	Lungime de lucru (mm)	Ambalare (buc./set)
E-11324	12	340	200	1
E-11330	12	540	400	1
E-11346	14	340	200	1
E-11352	14	540	400	1
E-11368	16	340	200	1
E-11374	16	540	400	1
E-11380	18	340	200	1
E-11396	18	540	400	1
E-11405	20	340	220	1
E-11411	20	540	420	1
E-11427	22	340	220	1
E-11433	22	540	420	1
E-11449	24	340	220	1
E-11455	24	540	420	1
E-11461	25	340	220	1
E-11477	25	540	420	1
E-11483	28	370	250	1
E-11499	28	570	450	1
E-11508	30	370	250	1
E-11514	30	570	450	1

Burghie cu extracție praf SDS-MAX

Burghiile cu extracție a prafului sunt ideale pentru găurirea betonului armat, asigurând o găurire curată și sunt compatibile cu aspiratoarele cu furtun de conectare cu diametrul de 28 mm. Conexiunea la alte aspiratoare se face cu ușurință folosind cuplajul de 24 (195546-0) pentru aspiratoarele: VC3211H/M, VC2211M, DVC350, DVC860L, DVC862L, DVC260. Utilizați adaptorul 24 (P-81745) pentru VC2012L, VC2512L, VC3011L și adaptorul 24 (P-70378) pentru VC3012L.



Cod	Diametru (Ø) (mm)	Lungime totală (mm)	Lungime de lucru (mm)	Ambalare (buc./set)
B-64428	16	600	400	1
B-64434	18	600	400	1
B-64440	20	600	400	1
B-64456	22	600	400	1
B-64462	24	600	400	1
B-64478	25	600	400	1
B-64484	28	600	400	1
B-64490	28	900	700	1
B-64509	30	600	400	1
B-64515	30	900	700	1
B-64521	32	600	400	1
B-64537	32	900	700	1
B-64543	35	600	400	1
B-64559	35	900	700	1

Burghie SDS-MAX ZENTRO pentru minerit

Burghiile SDS-MAX ZENTRO au vârful din carbură cu o geometrie extrem de solidă ce asigură un nivel ridicat de rezistență și performanță în cele mai dificile condiții de lucru. Cu burghiile SDS-MAX ZENTRO, capacitatea de găurire în piatră naturală este de până la 25% mai mare decât cu burghiile SDS-MAX convenționale. Marginile laterale de carbură ajută în mod activ la protejerea vârfului de carbură, fiind poziționate simetric la o distanță de 4x90°.



Cod	Diametru (Ø) (mm)	Lungime totală (mm)	Lungime de lucru (mm)	Ambalare (buc./set)
B-14613	32	570	450	1
B-15045	32	920	800	1

Burghie SDS-MAX standard

Burghiile SDS-MAX standard au două tășuri și sunt potrivite pentru găurirea pereților din zidărie și beton. Vârful din carbură de înaltă calitate, vârful de centrare și canelurile îmbunătățite pentru extragerea prafului permit viteze de găurire mai mari. Burghiile sunt disponibile în dimensiunile 12-40 mm.



Cod	Diametru (Ø) (mm)	Lungime totală (mm)	Lungime de lucru (mm)	Ambalare (buc./set)
D-33875	12	340	200	1
D-33881	12	540	400	1
D-33897	14	340	200	1
D-33906	14	540	400	1
D-33912	15	340	200	1
D-33928	15	540	400	1
D-33934	16	340	200	1
D-33940	16	540	400	1

Cod	Diametru (Ø) (mm)	Lungime totală (mm)	Lungime de lucru (mm)	Ambalare (buc./set)
D-33956	18	340	200	1
D-33962	18	540	400	1
D-33978	20	340	200	1
D-33984	20	540	400	1
D-33990	22	340	200	1
D-34001	22	540	400	1
D-34017	24	340	200	1
D-34023	24	540	400	1
D-34039	25	340	200	1
D-34045	25	540	400	1
D-34051	28	370	250	1
D-34067	28	570	450	1
D-34073	30	370	250	1
D-34089	30	570	450	1
D-34095	32	370	250	1
D-34104	32	570	450	1
D-34110	35	370	250	1
D-34126	35	570	450	1
D-34132	38	370	250	1
D-34148	38	570	450	1
D-34154	40	370	250	1
D-34160	40	570	450	1

Burghie SDS-MAX

Burghiile de străpungere Makita au o capacitate de găurire de la 40 la 80 mm în beton, piatră și piatră naturală. Vârful de centrare HM permite forarea rapidă. Vârful este proiectat pentru îndepărtarea rapidă a prafului și așchiilor. Se recomandă a fi utilizate cu ciocane rotopercutoare cu o greutate mai mare de 8 kg. Construcție robustă dintr-o singură bucată. În cazul găuririi în beton armat recomandăm evitarea armaturii pentru a evita deteriorarea burghiului.









Cod	Cod înlocuitor	Diametru (Ø) (mm)	Lungime totală (mm)	Lungime de lucru (mm)	Ambalare (buc./set)
B-57629	E-20080	40	550	450	1
B-57635	E-20096	45	550	450	1
B-57657	E-20111	55	550	450	1
B-57663	E-20127	55	990	850	1
B-57679	E-20133	65	550	450	1
B-57685	E-20149	65	990	850	1
B-57691	E-20155	80	550	450	1
B-57700	E-20161	80	990	850	1

Adaptoare bătut țaruș



Cod	Diametru (mm)	Lungime totală (mm)	Ambalare (buc./set)
E-13029	13,3 mm	260 mm	1
E-13035	16,5 mm	260 mm	1
E-13041	22,2 mm	260 mm	1

SETURI ACCESORII SDS-PLUS / SDS-MAX
Seturi accesorii SDS-Plus

Clasă calitate	Cod	Nr. piese	Dimensiuni			Cutie depozitare
			Dălți	Burghie	Șpițuri	
★★★★	E-20220	3	20x250 mm, 40x250 mm	/	250 mm	
★★★★	B-49105	12	/	3x (6x160 mm), 4x (8x160 mm), 3x (10x160 mm), 2x (12x160 mm)	/	
★★★	B-54704	5	/	6x110 mm; 8, 10x160 mm	/	
★★★	B-57532	5	/	Les: 4x105 mm, 5x116 mm, 6x123 mm; HSS-TiN: 3x90 mm, 4x105 mm	/	
★★	D-00795	5	/	5, 6, 8x110 mm; 6, 8x160 mm	/	
★★	D-17784	5	/	6, 6.5x110 mm; 8, 10, 12x160 mm	/	
★★	D-36049	5	/	6, 6, 8, 10, 12x160 mm	/	
★★	D-42379	5	2x (20x250 mm); 40x250 mm	/	2x250 mm	
★★	D-42385	10	20x250 mm	6x110 mm; 8x160 mm; 10, 12x210 mm; 10, 12, 16, 20x460 mm	250 mm	
★★	D-20111	13	20x250 mm	5, 6, 7, 8x110 mm; 6, 7, 8, 10, 12, 14x160 mm; 16x210 mm	250 mm	
★★	B-53877	17	20x140 mm; 20x250 mm; 40x250 mm	5, 6, 7, 8x110 mm; 5, 6, 7, 10x160 mm; 8, 10, 12x210 mm; 14x260 mm	140 mm; 250 mm	
★★	D-42444	17	20x140 mm; 20x250 mm; 40x250 mm	5, 6, 8, 10x110 mm; 6, 8, 10, 12x160 mm; 8, 10x210 mm; 12, 14x260 mm	140 mm; 250 mm	
★★	D-05181	3	20x250 mm; 40x250 mm	/	250 mm	
★★	D-40543	3	25x400 mm, 50x400 mm	/	400 mm	
★★	D-62723	12	/	3x (6x160mm), 3x (8x160 mm), 3x (10x160 mm), 3x (12x160mm)	/	
★★	D-74136	4	/	5x110 mm, 6x160 mm, 8x160 mm, 10x160 mm	/	
★★	D-74756	4	/	6x160 mm, 8x160 mm, 10x160 mm, 12x160 mmm	/	
★★	D-74728	4	/	6,5x160 mm, 8x160 mm, 10x160 mm, 12x160 mm	/	
★★	D-33853	25	/	5x (5x110 mm), 5x (6x110mm), 5x (6x160 mm), 5x (7x110 mm), 5x (7x160 mm)	/	

E-20220



B-49105



B-54704



B-57532



D-00795



D-17784



D-36049



D-42379



D-42385



D-20111



B-53877



D-42444



D-05181



D-40543



D-62723



D-74136



D-74756



D-74728



D-33853



ACCESORII PENTRU ASPIRAREA PRAFULUI PENTRU ROTOPERCUTOARE ȘI DEMOLATOARE SDS-PLUS / SDS-MAX
Atașamente pentru aspirarea prafului

	Cod	Descriere	Compatibil cu	Ambalare (buc./set)
	191F95-1	Sistem extracție praf DX10	HR3011, HR008	1
	191G00-4	Sistem extracție praf DX11	HR3012, HR009	1
	191E54-9	Sistem extracție praf DX12	HR001G, HR003G	1
	191E60-4	Sistem extracție praf DX14	HR002G, HR004G	1
	1911P2-6	Sistem extracție praf DX16	DHR183, HR010G	1
	1911P5-0	Rezevor praf cu filtru Hepa DX16	DX16, 1911P2-6	1
	1911P8-4	Adaptor extragere praf	DHR183, HR010G	1
	193472-7	Ansamblu colector praf	DHR202, DHR241, HR2020, HR2440, HR2440F, HR2440X, HR2450, HR2450F, HR2450T, HR2470, HR2810, HR2811	1
	195173-3	Burduf aspirare praf	HR2300, HR2600, HR2610, HR2611F, HR3011FC, HR3001C, HR007G	1
	195179-1	Burduf aspirare praf	DHR243, HR2300, HR2310T, HR2600, HR2320T, HR2630/T/F, HR2361FT, HR2641, HR2653T, HR2652, HR2653, HR3012FC	1
	195866-2	Ansamblu extracție praf SDS-MAX	HR4001C, HR4002, HR4010C, HR4011C, HR4501C, HR4510C, HR4511C	1
	196861-5	Set extracție praf SDS-MAX	HR5202C, HR5212C, HR5201C, HR5211C	1
	197148-8	Set extracție praf cu furtun	HM1304/B, HM1317C/CB, HM1801, HM1802, HM1810, HM1812	1
	197168-2	Set extracție praf fără furtun	HM1304/B, HM1317C/CB, HM1801, HM1802, HM1810, HM1812	1

	Cod	Descriere	Compatibil cu	Ambalare (buc./set)
	198362-9	Burduf aspirare praf SDS-Plus	DHR165, DHR171, DHR182, HR140D, HR166D, HR1830, HR1840, HR1841F	1
	199142-6	Set extracție praf	DHR400, HR005G, HR4003C, HR4013C	1
	199143-4	Set atașamente pentru extragerea prafului	DHR400, HM001G, HM002G, HR005G, HR006G, HM0870C, HM0871C, HM1101C, HM1111C, HM1203C, HM1213C, HM1214C, HR3530, HR3540C, HR3541FC, HR4002, HR4003C, HR4013C, HR4501C, HR4511C, HR5212C, HR5202C	1
	199144-2	Set atașamente pentru extragerea prafului	DHR400, HM001G, HM002G, HR005G, HR006G, HM0870C, HM0871C, HM1101C, HM1111C, HM1203C, HM1213C, HM1214C, HR3530, HR3540C, HR3541FC, HR4002, HR4003C, HR4013C, HR4501C, HR4511C, HR5212C, HR5202C	1
	199664-6	Sistem extracție praf DX05	DHR182	1
	199581-0	Sistem extracție praf DX08	DHR280	1
	199585-2	Sistem extracție praf DX09	DHR283	1
	199595-9	Recipient colectare praf DX05	DX05	1
	199596-7	Filtru HEPA pentru DX05	DX05	1
	1914X3-8	Sistem de extragere a prafului, fixare de perete		1
	421342-3	Capac de colectare a prafului	Ø 6 - 12 mm	1
	421384-7	Sigiliu de praf	DHR261, HR2020, HR2432, HR2440, HR2440F, HR2440X, HR2450, HR2450F, HR2450T, HR2470, HR2810, HR2811	1
	421664-1	Capac de colectare a prafului 120mm	Ø 10 - 18 mm	1
	421755-8	Capac transparent	HR1830	1
	423154-0	Capac colectare praf	HK1810	1

DĂLȚI ȘI ȘPIȚURI SDS-MAX
Șpițuri SDS-Max ★★★★★

Cod	Lățime (mm)	Lungime totală (mm)
D-34176	/	300
D-34182	/	400
D-34198	/	600
P-16237	/	280
P-16243	/	400
P-16259	/	600

Șpițuri expert SDS-Max ★★★★★

Cod	Lățime (mm)	Lungime totală (mm)
B-64325	/	400

Șpițuri cu autoascuțire SDS-Max ★★★★★

Cod	Lățime (mm)	Lungime totală (mm)
B-23064	/	400
B-10621	/	400

Șpițuri premium SDS-Max ★★★★★

Cod	Lățime (mm)	Lungime totală (mm)
B-64266	/	400

Dălți înguste SDS-Max ★★★★★

Cod	Lățime (mm)	Lungime totală (mm)
P-16265	25	280
P-16271	25	400
P-16287	25	600
D-34207	25	300
D-34213	25	400
D-34229	25	600

Dălți înguste expert SDS-Max ★★★★★

Cod	Lățime (mm)	Lungime totală (mm)
B-64331	25	400

Dălți înguste cu autoascuțire SDS-Max ★★★★★

Cod	Lățime (mm)	Lungime totală (mm)
B-64783	25	400

Dălți înguste premium SDS-Max ★★★★★

Cod	Lățime (mm)	Lungime totală (mm)
B-64272	25	400

Dălți late SDS-Max ★★★★★

Cod	Lățime (mm)	Lungime totală (mm)
P-16318	80	300
P-16324	30	300
P-16302	50	360
D-34235	50	400
D-34241	80	300

Dălți late expert SDS-Max ★★★★★

Cod	Lățime (mm)	Lungime totală (mm)
B-64347	50	400

Dălți late premium SDS-Max ★★★★★

Cod	Lățime (mm)	Lungime totală (mm)
E-20208	50	350
E-20214	50	350

Dălți tip lopată SDS-Max



Cod	Lățime (mm)	Lungime totală (mm)
P-23721	100	400

Dălți pentru caneluri SDS-Max



Cod	Lățime (mm)	Lungime totală (mm)
P-16293	26	300

Buciarde SDS-Max



Cod	Dimensiuni (mm)	Descriere
P-03947	60x60	Placă buciardare cap de ciocan
P-16352	200	Tijă suport placă buciardare

Adaptor SDS-Max



Cod	Lungime totală (mm)	Descriere
P-53914	190	Adaptor SDS-Max/SDS-Max

Adaptor SDS-Max la SDS-Plus



Cod	Lungime totală (mm)	Descriere
P-17027	220	Adaptor SDS-Max/SDS-Plus

Extensie SDS-Max



Cod	Lungime totală (mm)	Descriere
P-53936	750	Extensie SDS-Max/SDS-Max

DĂLȚI ȘI ȘPIȚURI SDS-PLUS

Șpițuri SDS-Plus ★★☆☆☆



Cod	Lățime (mm)	Lungime totală (mm)
P-05505	/	250
P-25068	/	250
D-19015	/	400

Șpițuri expert SDS-Plus ★★☆☆☆



Cod	Lățime (mm)	Lungime totală (mm)
B-64294	/	250

Șpițuri cu autoascuțire SDS-Plus ★★★★★



Cod	Lățime (mm)	Lungime totală (mm)
B-64761	/	250

Șpițuri premium SDS-Plus ★★★★★



Cod	Lățime (mm)	Lungime totală (mm)
B-64238	/	250

Dălți înguste SDS-Plus ★★☆☆☆



Cod	Lățime (mm)	Lungime totală (mm)
P-05511	20	250
P-25074	20	250
D-19021	20	400

Dălți înguste expert SDS-Plus ★★★★★

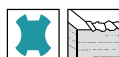

Cod	Lățime (mm)	Lungime totală (mm)
B-64303	20	250

Dălți înguste cu autoascuțire SDS-Plus ★★★★★



Cod	Lățime (mm)	Lungime totală (mm)
B-64777	20	250

Dălți înguste premium SDS-Plus ★★★★★



Cod	Lățime (mm)	Lungime totală (mm)
B-64244	20	250

Dălți late SDS-Plus ★★★★★



Cod	Lățime (mm)	Lungime totală (mm)
P-05527	40	200
P-24941	40	200
P-24935	60	250
A-30483	40	200

Dălți late expert SDS-Plus ★★★★★



Cod	Lățime (mm)	Lungime totală (mm)
B-64319	40	250

Dălți late premium SDS-Plus ★★★★★



Cod	Lățime (mm)	Lungime totală (mm)
E-20177	40	250
E-20183	50	250
E-20199	75	165

Dălți pentru îndepărtarea plăcilor SDS-Plus



Cod	Lățime (mm)	Lungime totală (mm)
P-63987	40	260

Dălți late cu autoascuțire SDS-Plus ★★★★★



Cod	Lățime (mm)	Lungime totală (mm)
B-14065	60	250

Dălți răzuire SDS-Plus



Cod	Dimensiuni (mm)	Descriere
A-68161	100x160	Răzuitor SDS-Plus
343411-9	100	Placă răzuire pentru A-68161

Dălți pentru caneluri SDS-Plus

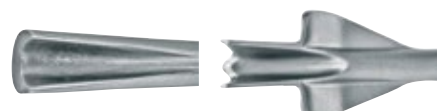

Cod	Lățime (mm)	Lungime totală (mm)
P-05533	22	P-05533
P-24963	22	P-24963

DĂLȚI ȘI ȘPIȚURI HEX

Șpițuri HEX 17 mm



Cod	Lățime (mm)	Lungime totală (mm)
P-13041	/	450
P-13035	/	280
D-16374	/	210
D-08682	/	280
D-16863	/	450

Dălți înguste HEX 17 mm



Cod	Lățime (mm)	Lungime totală (mm)
P-13057	25	280
D-26587	19	210
D-08707	19	280
D-16879	19	280

Dălți late HEX 17 mm ★★☆☆☆



Cod	Lățime (mm)	Lungime totală (mm)
D-52548	50	450
D-20694	50	280

Dălți pentru caneluri HEX 17 mm ★★☆☆☆



Cod	Lățime (mm)	Lungime totală (mm)
A-48555	22	280
A-48561	26	280

Dălți bătător HEX 17 mm



ASPHALT

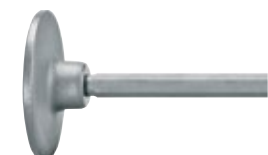

Cod	Lățime (mm)	Lungime totală (mm)
A-21428	22	280

Șpițuri HEX 19 mm ★★☆☆☆



Cod	Lățime (mm)	Lungime totală (mm)
P-13340	/	220
P-05620	/	400
P-05614	/	600
D-19196	/	450

Dălți înguste HEX 19 mm ★★☆☆☆



Cod	Lățime (mm)	Lungime totală (mm)
D-19205	26	450
P-05642	25	600

Dălți late HEX 19 mm ★★☆☆☆



Cod	Lățime (mm)	Lungime totală (mm)
P-05664	50	300
D-20096	60	300

Dălți pentru caneluri HEX 19 mm



Cod	Lățime (mm)	Lungime totală (mm)
P-13188	22	250

Șpițuri HEX 21 mm ★★☆☆☆



Cod	Lățime (mm)	Lungime totală (mm)
P-13378	/	320
P-13384	/	450
P-13390	/	600

Dălți înguste HEX 21 mm ★★☆☆☆



Cod	Lățime (mm)	Lungime totală (mm)
P-13415	26	450
P-13421	26	600

Dălți late HEX 21 mm ★★☆☆☆

Cod	Lățime (mm)	Lungime totală (mm)
P-13437	70	320

Șpițuri HEX 28,6 mm Tip B ★★☆☆☆

Cod	Lățime (mm)	Lungime totală (mm)
P-05692	/	400
D-65034	/	350
D-17631	/	410
D-61569	/	520

Șpițuri cu autoascuțire HEX 28,6 mm Tip B ★★★★★

Cod	Lățime (mm)	Lungime totală (mm)
B-10372		400

Dălți înguste HEX 28,6 mm Tip B ★★☆☆☆

Cod	Lățime (mm)	Lungime totală (mm)
P-05723	29	400
D-17647	28	410
D-17681	28	520

Dălți late HEX 28,6 mm Tip B ★★☆☆☆

Cod	Lățime (mm)	Lungime totală (mm)
P-05701	80	400

Dălți tip lopată HEX 28,6 mm Tip B

Cod	Lățime (mm)	Lungime totală (mm)
P-05717	125	400

Șpițuri HEX 30 mm ★★☆☆☆

Cod	Lățime (mm)	Lungime totală (mm)
P-05549	/	400
P-05561	/	700
P-05577	/	1000

Șpițuri cu autoascuțire HEX 30 mm ★★★★★

Cod	Lățime (mm)	Lungime totală (mm)
B-10388	/	400

Dălți înguste HEX 30 mm ★★☆☆☆

Cod	Lățime (mm)	Lungime totală (mm)
P-13487	32	400
P-13502	32	400

Dălți late HEX 30 mm ★★☆☆☆

Cod	Lățime (mm)	Lungime totală (mm)
P-13493	115	400
P-13518	115	400

ACCESORII PENTRU BURGHIE CU COROANĂ DE STRĂPUNGERE





Burghie cu coroană de străpungere

Burghiele cu străpungere se instalează rapid, sunt parte integrală a mașinii. Designul dintr-o singură bucată asigură rezistență la energia de impact și nu reduce din puterea generată de mașină. Aceste burghie asigură o performanță semnificativ mai mare în comparație cu burghiele cu aspirare sau burghiele convenționale. În cazul găuririi în beton armat recomandăm evitarea armaturii pentru a evita deteriorarea burghiului.



Cod	Diametru (Ø) (mm)	Ambalare (buc./set)
P-04008	35	1
P-03844	40	1
P-03850	50	1
P-04014	55	1
P-04020	60	1
P-03866	68	1
P-03872	80	1
P-04036	90	1

Accesorii

	Cod	Descriere	Lungime totală (mm)	Ambalare (buc./set)
	P-03888	Ax coroană de străpungere SDS-MAX	185	1
	P-03903	Ax fixare coroană de străpungere	160	1
	P-03925	Prelungitor coroană de străpungere 13 mm	280	1
	P-03931	Bolt coroană de străpungere	60	1

ACCESORII PENTRU COROANE DE GĂURIT BETON







Coroane de găurit beton

Coroanele sunt utilizate pentru găurirea betonului, cărămidei și pietrei. Stabilitate de rotație excepțională și o bună precizie realizată cu ajutorul dinților de ghidare.







Cod	Diametru (Ø) (mm)	Adâncime găurire (mm)	Ambalare (buc./set)
P-03791	65	60	1
P-03800	80	60	1
P-03816	90	60	1
P-03822	100	60	1
P-16374	125	60	1

Accesorii

	Cod	Descriere	Lungime totală (mm)	Ambalare (buc./set)
	P-03729	Adaptor pentru coroană, 13 mm	185	1
	P-03735	Adaptor pentru coroană, 13 mm	450	1
	P-03763	Pană de ejecție pentru coroană	140	1
	P-03838	Burghiu de centrare pentru coroană	11x120	1
	P-16994	Adaptor pentru coroană SDS-MAX	180	1
	P-17005	Adaptor pentru coroană SDS-MAX	450	1

ALTE ACCESORII
Lubrifianti





































	Cod	Descriere	Ambalare (buc./set)
	188088-1	Vaselină percuție - 30 g	1
	042017-7A	Vaselină N Nr.1 - 2,5 kg	1
	042025-8A	Vaselină FA Nr.2 - 2,5 kg	1
	042040-2A	Vaselină percuție R Nr.00 - 0,5 kg	1

ACCESORII PENTRU GĂURIRE MATERIALE MULTIPLE ȘI AMESTECARE

- Beton 
- Zidărie 
- Cărămidă 
- Piatră de calcar 
- Marmură 
- Granit 
- Plăci ceramice 
- Sticlă 
- Lemn 
- Gips carton 
- PAL 
- Plastic 
- Fibră de sticlă 
- Metal 
- Aluminiu 
- Oțel inoxidabil 
- Metale neferoase 
- Burghiu HSS 
- Burghiu HSS-Co 5% 
- Burghiu HSS-Co 8% 
- Burghiu HSS-TiN 
- Utilizare uscată 
- Utilizare umedă 
- Găurire fără percuție 
- Găurire cu frezare 
- Durată lungă de utilizare 



BURGHIE PENTRU LEMN

BURGHIU	DESCRIERE	VÂRF	PRINDERE	DIAMETRU (Ø)	MATERIAL			
					GROSIME			
BURGHIU PLAT PENTRU LEMN 	Ideal pentru găuri cu diametre mari și medii, în lemn de esență moale sau plastic moale.	Vârf de centrare 		6-36 mm		★★		
BURGHIU SPIRALAT PENTRU LEMN 	Cel mai popular burghiu pentru lemn, fiind recomandat pentru găuri cu diametre mici și medii. Poate fi utilizat pentru plastic moale sau lemn fiind foarte eficient pentru găuri curate și precise.	Vârf de centrare 	 	3-20 mm 2-15 mm		★★		★
BURGHIU ELICOIDAL PENTRU LEMN 	Ideal pentru găuri adânci cu diametre mari și medii în lemn moale și tare. Vârful elicoidal trage piesa și ajută la o găurire facilă și rapidă. Realizează găuriri curate și mai precise decât burghiul spiralat sau plat.	Vârf elicoidal 	 	6-30 mm 6-21 mm		★★		★
BURGHIU ELICOIDAL PENTRU LEMN 	Ideal pentru găuri adânci cu diametre mari și medii în placaje. Vârful elicoidal trage piesa și ajută la o găurire facilă și rapidă.	Vârf elicoidal 		8-36 mm		★		★★
BURGHIU DE COFRAJ 	Datorită lungimii totale (400 și 600 mm) poate fi utilizat pentru placaje suprapuse.	Vârf dăltuit 		8-30 mm		★	★	★★
BURGHIE AUTOFILETANTE PENTRU LEMN 	Potrivit pentru găuri cu diametre mai mari în material lemnos. Vârful elicoidal asigură drenarea rapidă și facilă a materialului. Potrivit pentru instalații sanitare și electrice.	Vârf elicoidal 	 7/16"	25-117 mm		★★		
BURGHIU FORSTNER PENTRU LEMN 	Potrivit pentru efectuarea găurilor curate sau a găurilor de diametre mari și medii de o calitate superioară. Recomandat pentru lucrări precise, cum ar fi confecționarea mobile.	Vârf de centrare (scurt) 		10-50 mm		★★		
CUTTER CIRCULAR REGLABIL 	Oferă posibilitatea de a tăia materiale diferite. Adâncimea maximă de găurire: tencuială 20 mm, placaj 12 mm, MDF 12 mm, plastic 4 mm, lemn 20 mm. Placajul și plăcile MDF trebuie să aibă grosimea mai mică de 12 mm, plăcile din plastic trebuie să aibă grosimea mai mică de 4 mm.	Vârf dăltuit 		30-200 mm		★		★



Lemn



Lemn cu cuie



Placaj



Material subțire



Material gros

★ Potrivit

★★ Recomandat

BURGHIE PENTRU LEMN**Burghie plate pentru lemn, tijă hexagonală**

Burghiele plate pentru lemn sunt potrivite pentru găurirea lemnului dur și moale și pentru lucrările de dulgherie. Diametre burghie: 8-36 mm.



Cod	Diametru (Ø) (mm)	Lungime totală (mm)	Ambalare (buc./set)
D-07680	8	150	1
D-07711	14	150	1
D-07733	16	150	1
D-07749	18	150	1
D-07755	20	150	1
D-07761	22	150	1
D-07777	24	150	1
D-07783	25	150	1
D-07799	26	160	1
D-07814	30	160	1
D-07820	32	160	1
D-07858	36	160	1

Burghie plate pentru lemn, tijă hexagonală

Burghiele plate pentru lemn sunt potrivite pentru găurirea lemnului dur și moale și pentru lucrările de dulgherie. Diametre burghie: 10-36 mm.



Cod	Diametru (Ø) (mm)	Lungime totală (mm)	Ambalare (buc./set)
P-58665	10	150	1
P-58671	12	150	1
P-58687	14	150	1
P-58713	18	150	1
P-58724	20	150	1
P-58730	22	150	1
P-58746	24	150	1
P-58752	25	150	1
P-58768	26	160	1
P-58774	28	160	1
P-58780	30	160	1
P-58796	32	160	1
P-58805	34	160	1
P-58811	35	160	1
P-58827	36	160	1

Burghie asimetrice pentru lemn, tijă cilindrică

Burghiile sunt extrem de potrivite pentru găurirea lemnului dur sau moale.



Cod	Diametru (Ø) (mm)	Lungime totală (mm)	Lungime de lucru (mm)	Ambalare (buc./set)
D-07026	3	60	30	1
D-07032	4	75	40	1
D-07048	5	85	45	1
D-07054	6	95	50	1
D-07157	6	315	150	1
D-07060	7	110	60	1
D-07076	8	115	65	1
D-07163	8	315	150	1
D-07082	9	135	75	1
D-07098	10	135	85	1
D-07179	10	315	150	1
D-07107	12	155	90	1
D-07185	12	315	150	1
D-07113	14	170	95	1
D-07191	14	315	150	1
D-07129	16	180	95	1
D-07200	16	315	150	1
D-07135	18	200	114	1
D-07216	18	315	150	1
D-07141	20	200	125	1
D-07222	20	315	150	1

Burghie asimetrice cu vârf de centrare pentru lemn, tijă cilindrică

Burghiile sunt extrem de potrivite pentru găurirea lemnului dur sau moale. Burghiile au vârf de centrare și o suprafață exterioră lustruită.



Cod	Diametru (Ø) (mm)	Lungime totală (mm)	Ambalare (buc./set)
P-57489	4	75	1
P-57495	5	85	1
P-57504	6	90	1
P-57510	7	105	1
P-57526	8	110	1
P-57532	9	115	1
P-57548	10	120	1
P-57554	12	140	1
P-57560	14	150	1
P-57576	16	160	1
P-57598	20	200	1
P-57607	22	210	1

Burghie pentru lemn, tijă 1/4"

Dezvoltarea mașinilor cu acumulatori a avansat și a dus la apariția burghiilor cu prindere hexagonală ce sunt utilizate mai ales împreună cu mașini de înșurubat extrem de puternice.



Cod	Diametru (Ø) (mm)	Lungime totală (mm)	Lungime de lucru (mm)	Ambalare (buc./set)
D-15861	3	75	33	1
D-15877	4	90	43	1
D-15883	5	100	52	1
D-15899	6	110	57	1
D-15908	8	115	75	1
D-15914	10	130	87	1
D-15920	12	150	101	1
D-15936	15	160	108	1

Burghie elicoidale pentru lemn, tijă hexagonală

Burghiele elicoidale pentru lemn sunt cele mai potrivite pentru găuri adânci cu o geometrie excelentă. Sunt potrivite pentru lemn dur și moale.



Cod	Diametru (Ø) (mm)	Lungime totală (mm)	Lungime de lucru (mm)	Ambalare (buc./set)
D-07238	6	200	130	1
D-07331	6	250	175	1
D-07244	8	200	130	1
D-07347	8	250	175	1
D-07434	8	400	230	1
D-07559	8	450	370	1
D-07250	10	200	130	1
D-07353	10	250	175	1
D-07440	10	400	230	1
D-07565	10	450	370	1
D-07266	12	200	130	1
D-07456	12	400	230	1
D-07571	12	450	370	1
D-07375	14	250	175	1
D-07462	14	400	230	1
D-07587	14	450	370	1
D-07381	16	250	175	1
D-07478	16	400	230	1
D-07593	16	450	370	1
D-07294	18	200	130	1
D-07397	18	250	175	1
D-07484	18	400	230	1
D-07602	18	450	370	1
D-07490	20	400	230	1
D-07618	20	450	370	1
D-07319	22	200	130	1
D-07412	22	250	175	1
D-07509	22	400	230	1

Cod	Diametru (Ø) (mm)	Lungime totală (mm)	Lungime de lucru (mm)	Ambalare (buc./set)
D-07624	22	450	370	1
D-07515	24	400	230	1
D-07630	24	450	370	1
D-07521	26	400	230	1
D-07646	26	450	370	1
D-07537	28	400	230	1
D-07652	28	450	370	1
D-07543	30	400	230	1
D-07668	30	450	370	1

Burghie elicoidale pentru lemn, tijă hexagonală lungă

Burghiile elicoidale pentru lemn sunt cele mai potrivite pentru găuri adânci cu o geometrie excelentă. Sunt potrivite pentru lemn dur și moale.



Cod	Diametru (Ø) (mm)	Lungime totală (mm)	Ambalare (buc./set)
E-07755	6	400	1
E-07761	8	400	1
E-07777	9	400	1
E-07783	10	400	1
E-07799	10.5	400	1
E-07808	11	400	1
E-07814	12	400	1
E-07820	13	400	1
E-07836	13.5	400	1
E-07842	15	400	1
E-07858	16	400	1
E-07864	18	400	1
E-07870	21	400	1
E-07886	22	400	1
E-07892	24	400	1
E-07901	27	400	1
E-07917	30	400	1
E-07923	10.5	500	1
E-07939	12	500	1
E-07945	13.5	500	1
E-07951	15	500	1
E-07967	18	500	1
E-07973	21	500	1
E-07989	24	500	1
E-07995	27	500	1
E-08006	30	500	1

Burghie elicoidale pentru lemn, tijă hexagonală 200 mm

Burghiele elicoidale pentru lemn sunt cele mai potrivite pentru găuri adânci cu o geometrie excelentă. Sunt potrivite pentru lemn dur și moale.



Cod	Diametru (Ø) (mm)	Lungime totală (mm)	Ambalare (buc./set)
P-58067	4	200	1
P-58073	5	200	1
P-58089	6	200	1
P-58095	8	200	1
P-58104	10	200	1
P-58110	12	200	1
P-58126	14	200	1
P-58160	22	200	1
P-58176	24	200	1

Burghie elicoidale pentru lemn, tijă hexagonală 300 mm

Burghiele elicoidale pentru lemn sunt cele mai potrivite pentru găuri adânci cu o geometrie excelentă. Sunt potrivite pentru lemn dur și moale.



Cod	Diametru (Ø) (mm)	Lungime totală (mm)	Ambalare (buc./set)
P-58213	8	300	1
P-58229	10	300	1
P-58241	14	300	1
P-58257	15	300	1
P-58263	16	300	1
P-58279	18	300	1
P-58285	20	300	1
P-58291	22	300	1
P-58300	24	300	1
P-58322	26	300	1

Burghie elicoidale pentru lemn, tijă hexagonală 450 mm

Burghiele elicoidale pentru lemn sunt cele mai potrivite pentru găuri adânci cu o geometrie excelentă. Sunt potrivite pentru lemn dur și moale.



Cod	Diametru (Ø) (mm)	Lungime totală (mm)	Ambalare (buc./set)
P-58350	8	450	1
P-58366	10	450	1
P-58372	12	450	1
P-58388	14	450	1
P-58394	15	450	1
P-58403	16	450	1
P-58425	20	450	1
P-58431	22	450	1

Cod	Diametru (Ø) (mm)	Lungime totală (mm)	Ambalare (buc./set)
P-58453	25	450	1
P-58475	28	450	1
P-58481	30	450	1

Burghie elicoidale pentru lemn, tijă hexagonală 600 mm

Burghiele elicoidale pentru lemn sunt cele mai potrivite pentru găuri adânci cu o geometrie excelentă. Sunt potrivite pentru lemn dur și moale.



Cod	Diametru (Ø) (mm)	Lungime totală (mm)	Ambalare (buc./set)
P-58528	14	600	1
P-58562	22	600	1
P-58590	28	600	1
P-58609	30	600	1

Burghie elicoidale pentru lemn, tijă 1/4"

Burghiele elicoidale pentru lemn sunt cele mai potrivite pentru găuri adânci cu o geometrie excelentă. Sunt potrivite pentru lemn dur și moale.



Cod	Diametru (Ø) (mm)	Lungime totală (mm)	Ambalare (buc./set)
D-15992	6	200	1
D-16003	8	200	1
D-16019	10	200	1
D-16025	12	200	1
D-16031	14	200	1
D-16047	16	200	1
D-16053	18	200	1
D-16069	20	200	1
D-16075	21	200	1

Burghie Forstner pentru lemn, tijă hexagonală



Cod	Diametru (Ø) (mm)	Lungime totală (mm)	Ambalare (buc./set)
P-58958	28	90	1
P-58964	30	90	1
P-58992	35	90	1
P-59025	40	90	1

Adaptoare burghie cu freză și capăt de înșurubare



Cod	Dimensiune șurub	Diametru burghiu (mm)	Adâncime (mm)	Tip bit	Ambalare (buc./set)
D-73209	6 (M3)	2,4	11 - 31	PH2	1
D-73215	8 (M4)	2,8	18 - 38	PH2	1
D-73221	10 (M5)	3,2	22 - 41	PH2	1

Adaptoare și burghie de rezervă



Cod	Dimensiune șurub	Diametru burghiu (mm)	Adâncime (mm)	Pentru modelul	Ambalare (buc./set)
D-73237	6 (M3)	2,4	11 - 31	D-73209	1
D-73243	8 (M4)	2,8	18 - 38	D-73215	1
D-73259	10 (M5)	3,2	22 - 41	D-73221	1

Burghie de rezervă



Cod	Dimensiune șurub	Diametru burghiu (mm)	Adâncime (mm)	Pentru modelul	Ambalare (buc./set)
D-80260	6 (M3)	2,4	11 - 31	D-73237	1
D-80276	8 (M4)	2,8	18 - 38	D-73243	1
D-80282	10 (M5)	3,2	22 - 41	D-73259	1

Set de rezervă

	Cod	Dimensiune șurub	Diametru burghiu (mm)	Adâncime (mm)	Ambalare (buc./set)
	D-73455	6 (M3)	2,4	11 - 31	1
		8 (M4)	2,8	18 - 38	
		10 (M5)	3,2	22 - 41	
		12 (M6)	3,6	26 - 45	

BURGHIE PENTRU METAL
Burghie HSS pentru metal, tijă cilindrică

Burghiele sunt potrivite pentru găurirea aliajelor feroase și neferoase și oferă viteze mari de găurire și o durată de viață prelungită. Sunt disponibile individual sau în seturi cu diametre cuprinse între 1,5 și 13 mm.



Cod	Diametru (Ø) (mm)	Lungime totală (mm)	Lungime de lucru (mm)	Ambalare (buc./set)
D-09656	1,5	40	18	1
D-06236	1,5	40	18	10/1
D-06242	1,75	46	20	10/1
D-09662	2	49	24	1
D-06258	2	49	24	10/1
D-06264	2,25	53	27	10/1
D-09678	2,5	57	30	1
D-06270	2,5	57	30	10/1
D-06286	2,75	61	33	10/1
D-09684	3	61	33	1
D-06292	3	61	33	10/1
D-06301	3,25	65	36	10/1
D-09690	3,5	70	39	1
D-06317	3,5	70	39	10/1
D-06323	3,75	70	39	10/1
D-09709	4	75	43	1
D-06339	4	75	43	10/1
D-06345	4,25	75	43	10/1
D-09715	4,5	80	47	1
D-06351	4,5	80	47	10/1
D-06367	4,75	80	47	10/1
D-09721	5	86	52	1
D-06373	5	86	52	10/1
D-06389	5,25	86	52	10/1
D-09737	5,5	93	57	1
D-06395	5,5	93	57	10/1
D-06404	5,75	93	57	10/1
D-09743	6	93	57	1
D-06410	6	93	57	10/1
D-06426	6,25	101	63	10/1
D-09759	6,5	101	63	1
D-06432	6,5	101	63	10/1
D-06448	6,75	109	69	10/1
D-09765	7	109	69	1
D-06454	7	109	69	10/1
D-06460	7,25	109	69	10/1
D-09771	7,5	109	69	1
D-06476	7,5	109	69	10/1
D-06482	7,75	117	75	10/1
D-09787	8	117	75	1
D-06498	8	117	75	10/1

Cod	Diametru (Ø) (mm)	Lungime totală (mm)	Lungime de lucru (mm)	Ambalare (buc./set)
D-06507	8,25	117	75	5/1
D-09793	8,5	117	75	1
D-06513	8,5	117	75	5/1
D-06529	8,75	125	81	5/1
D-09802	9	125	81	1
D-06535	9	125	81	5/1
D-06541	9,25	125	81	5/1
D-09818	9,5	125	81	1
D-06557	9,5	125	81	5/1
D-06563	9,75	133	87	5/1
D-09824	10	133	87	1
D-06579	10	133	87	5/1
D-06585	10,25	133	87	5/1
D-09830	10,5	133	87	1
D-06591	10,5	133	87	5/1
D-09846	11	142	94	1
D-06600	11	142	94	5/1
D-09852	11,5	142	94	1
D-06616	11,5	142	94	5/1
D-09868	12	151	101	1
D-06622	12	151	101	5/1
D-09874	12,5	151	101	1
D-06638	12,5	151	101	5/1
D-09880	13	151	101	1
D-06644	13	151	101	5/1

Burghie HSS-R pentru metal, tijă cilindrică



Cod	Diametru (Ø) (mm)	Lungime totală (mm)	Lungime de lucru (mm)	Ambalare (buc./set)
D-38532	1	34	12	10
D-38548	1.5	40	10	10
D-38554	2	49	24	10
D-38560	2.5	57	30	10
D-38576	3	61	33	10
D-38582	3.2	65	36	10
D-38598	3.5	70	39	10
D-38607	4	75	43	10
D-38613	4.2	75	43	10
D-38635	4.8	86	52	10
D-38641	5	86	52	10
D-38657	5.5	93	57	10
D-38663	6	93	57	10
D-38679	6.5	101	63	10
D-38685	7	109	69	10
D-38691	7.5	109	69	10
D-38700	8	117	75	10

Cod	Diametru (Ø) (mm)	Lungime totală (mm)	Lungime de lucru (mm)	Ambalare (buc./set)
D-38716	8.5	117	75	10
D-38722	9	125	81	10
D-38738	9.5	125	81	10
D-38744	10	133	87	10
D-38750	10.5	133	87	5
D-38766	11	142	94	5
D-38772	11.5	142	94	5
D-38788	12	151	101	5
D-38794	12.5	151	101	5
D-38803	13	151	101	5

Burghie HSS-Co (5%) pentru metal, tijă cilindrică

Burghiele HSS sunt construite în conformitate cu standardul DIN338 și sunt fabricate din aliaj de oțel M35 cu un conținut de Cobalt de 5%, ceea ce le face mai puternice și au o durată de viață mai mare în comparație cu burghiile convenționale. Vârful burghiului are 118° și previne riscul de alunecare pe material a burghiului. Sunt utilizate pentru găurirea oțelurilor ușoare, oțelurilor inoxidabile, materialelor dure prelucrate, îmbinărilor sudate și caroseriilor autovehiculelor.



Cod	Diametru (Ø) (mm)	Lungime totală (mm)	Lungime de lucru (mm)	Ambalare (buc./set)
D-17304	2,5	57	30	1
D-17310	3	61	33	1
D-17332	3,5	70	39	1
D-17348	4	75	43	1
D-17360	5	86	52	1
D-17376	5,5	93	57	1
D-17382	6	93	57	1
D-17398	6,5	101	63	1
D-17407	7	109	69	1
D-17413	7,5	109	69	1
D-17429	8	117	75	1
D-17457	9,5	125	81	1
D-17463	10	133	87	1
D-17479	10,5	133	87	1
D-17485	11	142	94	1
D-17491	11,5	142	94	1
D-17500	12	151	101	1
D-17516	12,5	151	101	1
D-17522	13	151	101	1

Burghie HSS-Co (5%) (de înaltă calitate) pentru metal, tijă cilindrică lungă

Burghie HSS și HSS-G au Cobalt în conținutul aliajului. Cobaltul oferă o rezistență mai bună atunci când găuriți la temperaturi ridicate. Burghiele HSS-G Co cu 5% Cobalt sunt fabricate în conformitate cu standardul DIN340 și sunt destinate utilizatorilor profesioniști. Vârful burghiului are 130° conform standardului DIN1412C. Potrivit pentru găurirea oțelurilor de rezistență la tracțiune mai mică de 1200 N/mm². Se poate utiliza pentru găurirea oțelului aliat și nealiat, oțelului inoxidabil, aliajelor, aluminiului, aliajelor de aluminiu, cuprului, bronzului și alamei.



Cod	Diametru (Ø) (mm)	Lungime totală (mm)	Ambalare (buc./set)
P-62745-10	1	56	10/1
P-62773-10	2,5	95	10/1
P-61519-10	3,5	70	10/1
P-62795-10	3,5	112	10/1
P-62810-10	4,5	126	10/1
P-62832-10	5,5	139	10/1
P-62854-10	6,5	148	10/1
P-62907-5	9	175	5/1
P-62963-5	12	205	5/1
P-62979-5	12,5	205	5/1
D-16617	1,5	40	5/1
D-16623	2	49	5/1
D-16639	2,5	57	5/1
D-16645	3	61	5/1
D-16695	5	86	5/1
D-16710	6	93	5/1
D-16732	7	109	5/1
D-16748	7,5	109	5/1
D-16754	8	117	5/1
D-16776	9	125	5/1
D-16782	9,5	125	5/1
D-16798	10	133	5/1
D-16807	10,5	133	5/1
D-16813	11	142	5/1
D-16829	11,5	142	5/1
D-16835	12	151	5/1
D-16841	12,5	151	5/1
D-16857	13	151	5/1

Burghie HSS-TiN pentru metal, tijă 1/4"

Burghiile sunt acoperite cu nitru de titan, ceea ce le asigură o durată de viață mai lungă. Tija hexagonală este potrivită pentru mașinile cu mandrină cu eliberare rapidă. Burghiile sunt disponibile cu diametre cuprinse între 3 și 13 mm.



Cod	Diametru (Ø) (mm)	Lungime totală (mm)	Lungime de lucru (mm)	Ambalare (buc./set)
D-14928	3	61	33	1
D-14934	3,2	82	43	1
D-16081	3,3	65	36	1
D-14940	4	75	43	1
D-14956	4,2	75	43	1
D-14962	5	86	52	1
D-14978	6	93	57	1
D-15827	8	117	75	1
D-15833	10	133	87	1
D-15849	12	151	101	1
D-15855	13	151	101	1

Burghie M-FORCE, tijă cilindrică triunghiulară



Cod	Diametru (Ø) (mm)	Lungime totală (mm)	Ambalare (buc./set)
D-37633	3.2	65	1
D-46626	3.3	65	1
D-37649	4.2	75	1
D-37655	5.2	86	1
D-29795	11	142	1

Burghie M-FORCE HSS-G pentru metal, tijă cilindrică triunghiulară

Burghie HSS-G de înaltă calitate pentru uz profesional. Vârful burghiului are un unghi de 130° și este construit în conformitate cu standardul DIN1412. Potrivit pentru găurirea oțelului, aliajelor din oțel cu rezistență mai mică de 950 Nm.



Cod	Diametru (Ø) (mm)	Lungime totală (mm)	Ambalare (buc./set)
P-60567-10	1,5	40	10/1
P-60785-10	7	109	10/1
P-60800-10	7,5	109	10/1
P-60894-5	11	142	5/1
P-60903-5	11,5	142	5/1
P-60919-5	12	151	5/1

Burghie M-FORCE HSS-G pentru metal, tijă cilindrică triunghiulară lungă

Burghie HSS-G de înaltă calitate pentru uz profesional. Vârful burghiului are un unghi de 130° și este construit în conformitate cu standardul DIN1412. Potrivit pentru găurirea oțelului, aliajelor din oțel cu rezistență mai mică de 950 Nm.



Cod	Diametru (Ø) (mm)	Lungime totală (mm)	Ambalare (buc./set)
P-62496-10	1	56	10/1
P-62505-10	1,5	70	10/1
P-62511-10	2	85	10/1
P-62527-10	2,5	95	10/1
P-62549-10	3,5	112	10/1
P-62561-10	4,5	126	10/1
P-62583-10	5,5	139	10/1
P-62599-10	6	139	10/1
P-62608-10	6,5	148	10/1
P-62614-10	7	156	10/1
P-62620-10	7,5	156	10/1
P-62636-10	8	165	10/1
P-62642-5	8,5	165	5/1
P-62658-5	9	175	5/1
P-62664-5	9,5	175	5/1
P-62670-5	10	184	5/1
P-62686-5	10,5	184	5/1
P-62701-5	11,5	195	5/1
P-62723-5	12,5	205	5/1
P-62739-5	13	205	5/1

Burghie în trepte HSS-G cu canal elicoidal



Cod	Diametru (Ø) (mm)	Recomandat pentru	Ambalare (buc./set)
P-69892	4-12	Oțel nealiat, oțel inoxidabil, aluminiu, fontă, oțel cu rezistență <800 N / mm ²	1
P-69901	4-20	Oțel nealiat, oțel inoxidabil, aluminiu, fontă, oțel cu rezistență <800 N / mm ²	1
P-69917	4-30	Oțel nealiat, oțel inoxidabil, aluminiu, fontă, oțel cu rezistență <800 N / mm ²	1

Zencuitoare HSS-Co

DIN335



Cod	Diametru (Ø) (mm)	Unghi de tăiere (°)	Tip prindere	Ambalare (buc./set)
P-73601	6,3	90	M3	1
P-73617	8,3	90	M4	1
P-73623	10,4	90	M5	1
P-73639	12,4	90	M6	1
P-73645	16,5	90	M8	1

BURGHIE PENTRU ZIDĂRIE
Burghie pentru zidărie, tijă cilindrică

Burghiile tradiționale au joc în timpul găuririi, ceea ce creează o gaură triunghiulară care este mai mare decât se dorește. Orice ai prinde într-o astfel de gaură nu va fi prins atât de ferm cât ar trebui. Când găuriți pentru ancore trebuie să utilizați burghie ce pot face o gaură precisă și rotundă.



Cod	Diametru (Ø) (mm)	Lungime totală (mm)	Lungime de lucru (mm)	Ambalare (buc./set)
D-05234	4	70	40	1
D-05256	6	100	60	1
D-05262	6	150	90	1
D-05290	8	110	60	1
D-05309	8	150	90	1
D-05321	10	150	90	1
D-05343	12	150	90	1
D-05359	13	150	90	1
D-05365	14	150	90	1
D-05371	15	150	90	1

Burghie pentru zidărie (de înaltă calitate), tijă cilindrică

Burghiile profesionale pentru zidărie sunt rezistente la impact și au o muchie de tăiere HM în conformitate cu DIN8039. Sunt potrivite pentru găurire în piatră naturală, cărămidă și beton.



Cod	Diametru (Ø) (mm)	Lungime totală (mm)	Ambalare (buc./set)
P-59592	3	60	1
P-59601	4	75	1
P-59617	5	85	1
P-59623	6	100	1
P-59798	6	400	1
P-59645	7	120	1
P-59760	8	200	1
P-59651	9	120	1
P-59667	10	120	1
P-59776	10	200	1
P-59673	11	150	1
P-59782	12	200	1
P-59695	13	150	1
P-59841	16	400	1
P-59857	18	400	1
P-59863	20	400	1
P-59879	22	400	1

Burghie pentru zidărie, tijă cilindrică



Cod	Diametru (Ø) (mm)	Lungime totală (mm)	Ambalare (buc./set)
E-06367	4	84	1
E-06410	6	110	1
E-06482	8	110	1

Burghie multimaterial, tijă cilindrică



Cod	Diametru (Ø) (mm)	Lungime totală (mm)	Lungime de lucru (mm)	Ambalare (buc./set)
E-10958	3	70	38	1
E-10964	4	75	40	1
E-10970	5	85	43	1
E-10986	5,5	100	50	1
E-10992	6	100	50	1
E-11003	6	150	90	1
E-11019	6,5	100	50	1
E-11025	6,5	150	90	1
E-11031	7	100	50	1
E-11047	8	120	60	1
E-11053	8	150	90	1
E-11069	10	150	90	1
E-11075	12	150	90	1
E-11081	13	150	90	1

BURGHIE PENTRU STICLĂ

Burghie pentru sticlă, tijă 1/4"

Burghiele pentru sticlă Makita au un vârf în formă de săgeată care facilitează găurirea în sticlă și ceramică. Burghiele sunt ideale pentru aplicații în bucătărie și baie.



Cod	Diametru (Ø) (mm)	Lungime totală (mm)	Ambalare (buc./set)
D-15942	4	65	1
D-15958	5	65	1
D-15964	6	65	1
D-15970	8	70	1
D-15986	10	80	1

Burghie pentru sticlă, tijă cilindrică triunghiulară



Cod	Diametru (Ø) (mm)	Lungime totală (mm)	Ambalare (buc./set)
D-78405	3	51	1
D-78411	4	51	1
D-78427	5	51	1
D-78433	6	58	1
D-78449	7	58	1
D-78455	8	58	1
D-78461	10	96	1
D-78477	12	96	1
D-78483	14	96	1
D-78499	16	100	1

Burghie pentru sticlă, tijă cilindrică





Burghiele pentru sticlă Makita au un vârf în formă de săgeată care facilitează găurirea în sticlă și ceramică. Burghiele sunt ideale pentru aplicații în bucătărie și baie.



Cod	Diametru (Ø) (mm)	Lungime totală (mm)	Ambalare (buc./set)
P-60012	3	65	1
P-60028	4	65	1
P-60040	6	65	1
P-60056	7	70	1
P-60062	8	70	1
P-60084	10	98	1
P-60090	12	98	1
P-60109	13	98	1

BURGHIE PENTRU SOL

Burghie pentru sol cu prindere 3/4"



	Cod	Descriere	Diametru (mm)	Lungime totală (mm)	Lungime de lucru (mm)	Ambalare (buc./set)
	B-54380	Cheie cu impact pentru burghie de pământ	-	-	-	1
	B-54396	Pin pentru cheie de impact (burghiu de sol) 3/4	-	-	-	1
	B-54405	Inel O pentru cheie cu impact 3/4	-	-	-	1
	B-57576	Burghiu de pământ cu cheie, pin și inel O	40	600	530	1

Burghie pentru sol cu prindere Hex 10 mm

Cod	Diametru (mm)	Lungime totală (mm)	Lungime de lucru (mm)	Ambalare (buc./set)
D-75415	30	600	200	1
D-75421	45	600	200	1
D-75443	100	600	200	1
D-75459	130	600	200	1





SETURI PENTRU GĂURIRE

Cod	Nr. piese în set	Dimensiuni		
		Piatră 	Metal 	Lemn 
E-11536	5	4, 5, 6, 8, 10 mm		
D-30106	5		5, 6, 8 mm	6, 8 mm
D-30508	5		4, 5, 6, 8, 10 mm	
D-16514	5	5x (8x110 mm)		
D-77241	6		2, 3, 4, 5, 6, 8 mm	
D-71962	9	5, 6, 8 mm	5, 6, 8 mm	5, 6, 8 mm
D-30069	9	5, 6, 8 mm	5, 6, 8 mm	5, 6, 8 mm
D-46202	18	3, 4, 5, 6, 8, 10 mm	3, 4, 5, 6, 8, 10 mm	3, 4, 5, 6, 8, 10 mm
D-67527	19		3,2, 3,5, 4, 4,5, 5, 5,5, 6, 6,5, 7, 8, 10, 2x1,5, 2x2, 2x2,5, 2x3 mm	
D-78346	6		2, 3, 4, 5, 6, 8 mm	
D-78352	19		1, 1,5, 2, 2,5, 3, 3,5, 4, 4,5, 5, 5,5, 6, 6,5, 7, 7,5, 8, 8,5, 9, 9,5, 10 mm	
D-78368	25		1, 1,5, 2, 2,5, 3, 3,5, 4, 4,5, 5, 5,5, 6, 6,5, 7, 7,5, 8, 8,5, 9, 9,5, 10, 10,5, 11, 11,5, 12, 12,5, 13 mm	



SETURI PENTRU GĂURIRE ȘI ÎNȘURUBARE

Cod	Nr. piese în set	Burghe			Carote	Vârfuri de înșurubare	Chei tubulare	Scule de mână
		Piatră 	Metal 	Lemn 				
P-30829	21	✓	✓			✓		
E-07032	27	✓	✓	✓		✓		
E-07054	29	✓	✓	✓		✓		
B-68498	34	✓	✓	✓		✓	✓	
D-36980	34	✓	✓	✓		✓	✓	
B-54106	38		✓			✓	✓	
D-58877	42		✓			✓	✓	
B-53908	62	✓	✓	✓		✓	✓	
B-49638	69	✓	✓	✓		✓	✓	
B-49725	96	✓	✓	✓		✓	✓	✓
E-10730	102	✓	✓	✓	✓	✓		✓
B-68432	102	✓	✓	✓		✓	✓	
B-49884	116	✓	✓	✓		✓	✓	✓
D-37194	200	✓	✓	✓	✓	✓	✓	✓
E-06270	212	✓	✓	✓	✓	✓	✓	✓
E-11689	256	✓	✓	✓	✓	✓	✓	✓

P-30829



E-07032



E-07054



B-68498



D-36980



B-54106



D-58877



B-53908



B-49638



B-49725



E-10730



B-68432



B-49884



D-37194









E-06270



E-11689



CAROTE

Carote Ezychange	Carote Bi-Metal	Carote Bi-Metal pentru tablă
<p>Ezychange</p> <p>Geometrie progresivă a dinților</p>  <p>Adaptor Ezychange</p> <p>HSS Bi Metal Co 8%</p>	<p>Geometrie progresivă a dinților</p>  <p>Adaptor standard</p> <p>HSS Bi Metal</p>	<p>HSS Bi Metal Co 8%</p> <p>Geometrie progresivă a dinților</p>  <p>Arc ejector</p> <p>Opritorul absoarbe impactul când carota intră în metal</p>
Carote multifuncționale TCT	Carote cu margine carbură wolfram	Carote diamantate pentru găurire la umed a ceramicii dure
<p>TCT</p>  <p>Datorită formei speciale se evacuează rapid șpanul</p>	<p>Adaptor standard</p>  <p>Particulele mari (#20-30) permit o carotare curată și rapidă</p>	<p>Adaptor standard</p>  <p>Particulele diamantate permit o carotare rapidă și durată de viață extinsă</p>

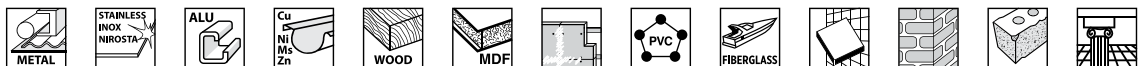

Aplicații	Metal	Inox	Aluminiu	Metale neferoase	Lemn	MDF	Gips carton	PVC	Fibră de sticlă	Plăci ceramice	Cărămidă	Piatră de calcar	Marmură
Carote Ezychange Ezychange	★★	★	★★	★★	★			★★					
Carote Bi-Metal	★★		★	★	★★			★★					
Carote Bi-Metal pentru tablă	★★	★★	★	★									
Carote multifuncționale TCT					★★	★★	★★	★★	★★	★	★	★	
Carote cu margine carbură wolfram										★★	★★		
Carote diamantate pentru găurire la umed a ceramicii dure										★★			★★

★★: Recomandat ★: Adecvat

CAROTE EZYCHANGE
Carote Ezychange

Carotele Ezychange au diametre de la 19 la 152 mm și pot fi atașate la un adaptor cu burghiu de centrare cu schimbare rapidă. Acest lucru permite nu doar înlocuirea rapidă a carotei ci și utilizarea în condiții de siguranță. Carotele sunt fabricate din oțel HSS Bi-Metal cu 8% Cobalt. Au o geometrie progresivă a dinților ce asigură o durată de viață mai lungă și viteze de tăiere mai mari. Sunt potrivite pentru a tăia fier și materiale neferoase, oțel inoxidabil, aluminiu, lemn și plastic.

Ezychange

Cod	Diametru (Ø) (mm)	Adâncime de găurire (mm)	Turație găurire metale neferoase (min ⁻¹)	Turație găurire oțel inoxidabil (min ⁻¹)	Turație găurire lemn (min ⁻¹)	Turație găurire oțel (min ⁻¹)	Turație găurire aluminiu (min ⁻¹)	Turație găurire metale (min ⁻¹)
B-11293	22	40	520	195	3000	390	585	520
E-14152	67	40	180	65	1850	130	200	180
B-11483	92	40	120	45	1200	90	140	120
E-14168	89	40	120	45	1200	90	140	120
E-14174	133	40	120	45	1200	90	140	120

Ezychange
Accesorii pentru carote Ezychange



	Cod	Descriere	Ambalare (buc./set)
	B-11536	Adaptor Ezychange cu burghiu de centrare HSS-G	1



Set carote Ezychange



Ezychange

	Cod	Descriere	Diametru (mm)	Ambalare (buc./set)
	E-12304	Set carote Ezychange pentru instalatori, 7 piese	19, 22, 29, 38, 44, 57	1
	E-12326	Set carote Ezychange pentru electricieni, 7 piese	20, 25, 32, 40, 51, 65	1

CAROTE HSS BI-METAL





Carote HSS Bi-Metal

Carotele HSS-Bi-Metal au dinți cu geometrie variabilă și sunt potrivite pentru tăierea oțelului, aluminiului, cuprului, alamei, lemnului și plasticului. Aceste carote sunt incluse în seturile pentru instalatori și electricieni în dimensiunile cele mai des utilizate. Se pot prinde în adaptoare cu prindere hexagonală, cilindrică și SDS-Plus.



Cod	Diametru (Ø) (mm)	Turație găurire oțel (min ⁻¹)	Turație găurire metale (min ⁻¹)	Turație găurire aluminiu (min ⁻¹)	Turație găurire lemn (min ⁻¹)	Ambalare (buc./set)
D-16994	16	275	550	825	3.000	1
D-17005	19	230	460	690	3.000	1
D-17011	22	195	390	580	3.000	1
D-17033	25	175	350	525	2.700	1
D-17267	29	150	300	450	2.700	1
D-17049	32	140	275	410	2.400	1
D-17055	35	125	250	375	2.400	1
D-17061	38	115	230	345	2.400	1
D-17273	40	110	220	330	2.100	1
D-17077	44	95	195	295	2.100	1
D-17083	51	85	170	255	2.000	1
D-24876	54	80	160	240	2.000	1
D-17099	57	75	150	225	2.000	1
D-25688	60	70	140	220	2.000	1
D-17108	68	65	130	190	1.800	1
D-25694	70	60	125	185	1.800	1
D-17114	76	55	115	170	1.800	1
D-17142	105	40	80	120	1.000	1
D-17158	127	30	65	90	800	1
D-17164	152	25	55	75	800	1





Accesorii pentru carote HSS Bi-Metal

	Cod	Descriere	Ambalare (buc./set)
	D-17170	Adaptor tijă Hex cu burghiu centrare, 14-30 mm	1
	D-17186	Adaptor tijă Hex cu burghiu centrare, 32-152 mm	1
	D-17192	Burghiu centrare 71 mm	1
	D-17603	Adaptor SDS-Plus cu burghiu centrare, 14-30 mm	1
	D-17619	Adaptor SDS-Plus cu burghiu centrare, 32-76 mm	1

Set carote HSS Bi-Metal

Carotele HSS-Bi-Metal au dinți cu geometrie variabilă și sunt potrivite pentru tăierea oțelului, aluminiului, cuprului, alamei, lemnului și plasticului. Aceste carote sunt incluse în seturile pentru instalatori și electricieni în dimensiunile cele mai des utilizate. Se pot prinde în adaptoare cu prindere hexagonală, cilindrică și SDS-Plus.



	Cod	Descriere	Carote în set (mm)	Ambalare (buc./set)
	D-47117	Set 6 carote HSS-Bi-Metal pentru instalatori 19-57 mm	19, 22, 29, 38, 44, 57	1
	D-47123	Set 6 carote HSS-Bi-Metal pentru electricieni 16-51 mm	16, 20, 25, 32, 40, 51	1
	D-70203	Set 5 carote pentru lemn/gips + adaptor, 32-64 mm	32, 38, 48, 54, 64	1
	D-47282	Set 9 carote HSS-Bi-Metal pentru electricieni 19-68 mm	19, 22, 29, 35, 38, 51, 54, 57, 68	1
	D-63971	Set 11 carote HSS-Bi-Metal pentru instalatori 19-75 mm	9, 22, 25, 29, 35, 38, 44, 51, 57, 68, 75	1

	Cod	Descriere	Carote în set (mm)	Ambalare (buc./set)
	D-63993	Set 13 carote Bim pentru uz general	16, 19, 22, 25, 32, 35, 37, 44, 51, 57, 64, 68, 76	1

CAROTE BI-METAL-CO (8%)

Set carote Bi-Metal-Co (8%)



	Cod	Descriere	Carote în set	Ambalare (buc./set)
	B-38679	Set 10 carote Bi-M-Co pentru electricieni	Carote: 20, 25, 32, 38, 51, 64 mm; Adaptor hex 10 mm burghiu centrare 16-35 mm; adaptor hex 13 mm; burghiu de centrare 38-152 mm; burghiu de centrare, arc de ejeție	1

CAROTE MULTIFUNȚIONALE TCT

Carote multifunționale TCT

RECOMANDARE PENTRU UTILIZARE: Când găuriți poziționați carota la un unghi de 90 de grade.



Cod	Diametru (mm)	Adâncime de găurire (mm)	Turație găurire în lemn (min ⁻¹)	Turație găurire în plastic (min ⁻¹)	Turație găurire în gresie (min ⁻¹)	Turație găurire în cărămidă (min ⁻¹)	Ambalare (buc./set)
D-42678	19	50	1000	800	500	800	1
D-42690	25	60	1000	800	500	800	1
D-42709	29	60	1000	800	500	800	1
D-42737	35	60	1000	800	500	800	1
D-42743	38	60	800	600	400	700	1
D-42759	40	60	800	600	400	700	1
D-42765	45	60	800	600	400	700	1
D-42771	48	60	800	600	400	700	1
D-42787	50	60	800	600	400	700	1
D-42793	51	60	800	600	400	700	1
D-42802	54	60	600	400	400	600	1
D-42818	55	60	600	400	400	600	1
D-42824	57	60	600	400	400	600	1
D-42830	60	60	600	400	400	600	1
D-42846	64	60	600	400	400	600	1
D-42868	67	60	600	400	400	600	1
D-42874	68	60	600	400	400	600	1
D-42880	70	60	600	400	400	600	1
D-45026	73	60	600	400	400	600	1

Cod	Diametru (mm)	Adâncime de găurire (mm)	Turație găurire în lemn (min ⁻¹)	Turație găurire în plastic (min ⁻¹)	Turație găurire în gresie (min ⁻¹)	Turație găurire în cărămidă (min ⁻¹)	Ambalare (buc./set)
D-45048	79	60	400	300	300	300	1
D-45331	80	60	400	300	300	300	1
D-45347	83	60	400	300	300	300	1
D-45353	85	60	400	300	300	300	1
D-45369	89	60	400	300	300	300	1
D-50304	95	60	400	300	300	300	1
D-50310	102	60	400	300	300	300	1
D-50326	105	60	400	300	300	300	1

Accesorii pentru carote TCT







Cod	Descriere	Ambalare (buc./set)
D-50332	Adaptor pentru carote TCT, 13 mm, 22-105 mm	1
D-50398	Adaptor Hex pentru carote HSS 6,35x90 mm pentru 11 mm, 19 mm	1
D-50407	Adaptor pentru carote HSS 6,35x90 mm pentru SDS-Plus, 19 mm	1
D-50429	Burghiu de centrare pentru carote TCT 8x100, carote 22-105 mm	1
D-50435	Burghiu de centrare 6,35x90 mm, 19 mm	1
D-50441	Burghiu de centrare pentru carote TCT 8x90 mm, 19 mm	1



CAROTE DIAMANTATE**Carote diamantate pentru găurire umedă**

Cod	Diametru (mm)	Lungime totală (mm)	Tip prindere	Pentru modelul	Ambalare (buc./set)
P-65822	122	400	UNC 5/4"	DBM230	1
P-65838	132	400	UNC 5/4"	DBM230	1

Alte accesorii pentru găurire diamantată umedă

	Cod	Descriere	Lungime totală (mm)	Pentru modelul	Ambalare (buc./set)
	P-40098	Set de montare a suportului (P-54190)	/	DBM230	1
	P-40082	Stand	/	DBM130, DBM131	1
	P-54190	Stand găurire diamantată	/	DBM230	1
	P-54221	Set atașamente pentru vidare (P-54190)	/	DBM230	1

Carote diamantate

Cod	Diametru (mm)	Lungime totală (mm)	Pentru modelul	Ambalare (buc./set)
E-25220	102	150	DBM080; DBM130; DBM131; 8406; 8406C	1
E-25236	107	150	DBM080; DBM130; DBM131; 8406; 8406C	1
E-25242	112	150	DBM080; DBM130; DBM131; 8406; 8406C	1
E-25258	117	150	DBM080; DBM130; DBM131; 8406; 8406C	1
E-25264	122	150	DBM080; DBM130; DBM131; 8406; 8406C	1

Cod	Diametru (mm)	Lungime totală (mm)	Pentru modelul	Ambalare (buc./set)
E-25270	127	150	DBM080; DBM130; DBM131; 8406; 8406C	1
E-25286	132	150	DBM080; DBM130; DBM131; 8406; 8406C	1
E-25292	152	150	DBM080; DBM130; DBM131; 8406; 8406C	1
E-25301	Drept la M16		8406; 8406C	1
E-25317	M18 la M16		DBM080; DBM130; DBM131	1

BURGHIE CAROTĂ PENTRU GĂURIRE MAGNETICĂ

Burghie carotă pentru găurire magnetică, prindere Weldon 19 mm







Cod	Diametru (mm)	Lungime de lucru (mm)	Pentru modelul	Ambalare (buc./set)
HB-13S	13	25	HB500	1
HB-14S	14	25	HB500	1
HB-15S	15	25	HB500	1
HB-16S	16	25	HB500	1
HB-17S	17	25	HB500	1
HB-18S	18	25	HB500	1
HB-19S	19	25	HB500	1
HB-20S	20	25	HB500	1
HB-22S	22	25	HB500	1
HB-24S	24	25	HB500	1
HB-25S	25	25	HB500	1
HB-26S	26	25	HB500	1
HB-28S	28	25	HB500	1
HB-30S	30	25	HB500	1
HB-32S	32	25	HB500	1
HB-20L	20	50	HB500	1
HB-24L	24	50	HB500	1
HB-28L	28	50	HB500	1
HB-30L	30	50	HB500	1
HB-32L	32	50	HB500	1
HB-34L	34	50	HB500	1
HB-35L	35	50	HB500	1
HB-36L	36	50	HB500	1
HB-42L	42	50	HB500	1
HB-45L	45	50	HB500	1
HB-PILOTL	/	50	HB500	1



MANDRINE**Mandrine rapide**

	Cod	Diametre de prindere (mm)	Dimensiune filet	Compatibil cu	Ambalare (buc./set)
	196309-7	0,8-10	1/2"-20 UNF	DDF343, DHP343, 6281,6271, 6261	1
	763181-8	0,8-10	1/2"-20 UNF	MT064	1
	763187-6	0,8-10	1/2"-20 UNF	6260D, 6270D, 6280D, 6207D, 8270D, 8280D, 8270DW	1
	763228-8	0,8-10	3/8"-24 UNF	DF330D, HP330D, DDA341, DDA351, DF331D, HP331D	1
	763229-6	0,8-10	1/2"-20 UNF	8291, 8281, 8271, BHP343, DHP343, HP330D, HP331D, HP347D	1
	766009-9	0,8-10	1/2"-20 UNF	6207DWDE	1
	766012-0	0,8-10	1/2"-20 UNF	MT080, DF0300, HP0300	1
	192685-7	1,5-13	1/2"-20 UNF	HP2041	1
	194254-0	1,5-13	1/2"-20 UNF	HP2051, HP2051H, HP2071, DP4011, HB500	1
	196193-0	1,5-13	1/2"-20 UNF	HP1631, HP1641	1
	136405-9	1,5-13	/	HP001G	1
	763178-7	1,5-13	1/2"-20 UNF	6390D, 8390D	1



	Cod	Diametre de prindere (mm)	Dimensiune filet	Compatibil cu	Ambalare (buc./set)
	763196-5	1,5-13	1/2"-20 UNF	DDF451, DHP451, DDF441, DHP44, DDF444, DDF454, DHP444, DHP454	1
	766019-6	1,5-13	1/2"-20 UNF	MT818, M8104	1
	766027-7	1,5-13	1/2"-20 UNF	DDF446, DDF456, DHP484, DHP485	1
	P-15718	1,5-13	1/2"-20 UNF	6013B, 6013BR, 6300-4, DP4001, DP4003, DP4700, HP1620-HP1621K, HP2050-HP2051F, HP2070-HP2071F	1
	196307-1	1,5-13	1/2"-20 UNF	6260, 6270, 6280D	1
	766026-9	1-10	3/8"-24 UNF	MT607, M6002	1
	196306-3	1,5-13	/	DDF453	1

Mandrine cu cheie

	Cod	Diametre de prindere (mm)	Dimensiune filet	Compatibil cu	Ambalare (buc./set)
	P-04313	0,5-10	3/8"-24 UNF	6408, 6410, 6510LVR	1
	192887-5	0,5-6,5	3/8"-24 UNF	6501, DP2010	1
	763174-5	1,5-10	1/2"-20UNF	DA3010, DDA350, DDA340	1
	766016-2	1,5-13	1/2"-20 UNF	HP1630, HP1640	1
	193822-6	1-13	1/2"-20 UNF	DS4010, DS4011, HP2050, HP2070, HB500, 6300-4, DP4700	1

	Cod	Diametre de prindere (mm)	Dimensiune filet	Compatibil cu	Ambalare (buc./set)
	192877-8	2-13	1/2"-20 UNF	6305	1
	193318-7	2-13	Cap arbore	DA4000LR	1
	763232-7	2-13	-	MT817	1

Accesorii mandrină cu cheie









	Cod	Descriere	Compatibil cu	Ambalare (buc./set)
	410102-8	Suport cheie mandrină	763430-3, 763432-9	1
	418163-2	Suport cheie mandrină	763441-8, 763418-3	1
	763418-3	Cheie pentru mandrină cu cheie	192887-5	1





ACCESORII PENTRU AMESTECARE
Mixere

Mixer rotund (RK80, RK120) pentru: bitum, vopsele, adezivi, chituri și tencuială. Mixer spiralat (WK90, WK140) pentru: adezivi pentru construcții, șapă, mortar, adeziv pentru gresie, chit, produse de curățat, chituri, acoperiri pentru izolație termică. Mixer MK100 pentru: adezivi pentru construcții, beton, șapă, mortare gata amestecate, mortare de nivelare adezive, toate tipurile de mortar, tencuială. Mixer inversat MK140 pentru: dispersii, vopsele, mortar de var, tencuieli termoizolante.





	Cod	Descriere	Tip	Diametru (mm)	Lungime totală (mm)	Capacitate amestecare (kg)	Putere amestecare (W)	Turație în gol (min ⁻¹)	Prindere	Amestec ()
	P-02331	Mixer pentru vopseluri și adezivi	RK80	85	400	10-15	>500	500-800		↓
	P-02347	Mixer pentru tencuieli și adezivi	WK90	90	400	7-10	>500	600	8mm	↑
	P-02353	Mixer pentru adezivi	MK100	100	590	5-15	>600	400-500	10mm	↑
	P-22012	Mixer pentru vopseluri și tencuieli	RK120	120	590	15-30	>950	500	M14	↓
	P-22040	Mixer pentru vopseluri și adezivi	WK140	135	590	15-30	>1.000	400	M14	↑
	P-22056	Mixer pentru vopseluri	MK140	120	590	15-25	>900	500	M14	↓
	D-80494	Padelă amestecare lichide	M14	120	600	-	-	-	-	-
	D-80503	Padelă amestecare materiale vâscoase	M14	120	600	-	-	-	-	-
	D-80519	Padelă amestecare materiale uscare rapidă	M14	120	600	-	-	-	-	-

	Cod	Descriere	Tip	Diametru (mm)	Lungime totală (mm)	Capacitate amestecare (kg)	Putere amestecare (W)	Turație în gol (min ⁻¹)	Prindere	Amestec ()
	D-80525	Padelă amestecare lichide	3/8" Hex	120	600	-	-	-	-	-
	D-80531	Padelă amestecare materiale vâscoase	3/8" Hex	120	600	-	-	-	-	-





Mixere circulare cu lamele amestecare

Lamelele de amestecare sunt produse din oțel inoxidabil. Forma lamei asigură o amestecare rapidă și echilibrată. Mixerul cu lamele este potrivit pentru amestecarea lichidelor, a vopselurilor cu emulsie și a lacurilor.















	Cod	Descriere	Diametru (mm)	Compatibil cu	Ambalare (buc./set)
	A-43670	Cap amestecare cu lamele	130	M6600, DUT130	1
	A-43686	Cap amestecare cu lamele	150	M6600	1
	A-43692	Cap amestecare cu lamele	165	M6600, MT660, UT1305, DUT130	1

Alte accesorii

	Cod	Descriere	Lungime totală (mm)	Prindere	Compatibil cu	Ambalare (buc./set)
	265220-5	Șurub hexagonal	/	M8 X 18	UT1305, DUT130, M6600, MT660	1
	324929-9	Adaptor de la 5/8" la M14	/	5/8"	UT2204, MT660, M6600	1
	P-02325	Adaptor mixer de la 5/8"-16UNF la M14	60	5/8"	DA6301	1
	P-22062	Adaptor mixer de la 1/2"-20UNF la M14	12.7	1/2"	6013B	1

ACCESORII PENTRU ÎNȘURUBARE

- Drept (SL) 
- Phillips (PH) 
- Pozidrive (PZ) 
- Torx 
- Pătrat 
- Hex 
- Prindere pătrată 3/8" 
- Prindere pătrată 3/4" 
- Prindere pătrată 1/2" 
- Prindere pătrată 1" 
- Priză îmbunătățită 
- Vârf ranforsat 
- Cap magnetic 
- Confectionat din aliaj oțel-crom-molibden 



BIȚI ÎNȘURUBARE - METODE DE UTILIZARE

Bit

1x
Life



Bit pentru gips carton

1x
Life



Bit de torsiune

10x
Life **Impact GOLD**



Bit de torsiune cu aderență mai bună pentru lemn

10x
Life **Impact GOLD**



Bit de torsiune armat Enduro pentru metal

15x
Life **Impact GOLD**



Suport bit magnetic

1x
Life



Suport universal cu eliberare rapidă

1x
Life



Suport magnetic bit torsiune

2x
Life **Impact GOLD**



Suport bit ultra magnetic

2x
Life **Impact GOLD**



Bit flexibil

Doar pentru șurubelnițe



Bit de înșurubare

1x
Life



Bit cu două vârfuri

1x
Life



Bit de torsiune

10x
Life **Impact GOLD**



Bit Shorton

10x
Life **Impact GOLD**



Bit de torsiune dublu

12x
Life **Impact GOLD**



Bit torsiune pentru lemn

10x
Life **Impact GOLD**



Bit torsiune endure metal

15x
Life **Impact GOLD**



Bit cu două capete torsiune înșurubare pentru metal

10x
Life **Impact GOLD**



Bit cu două capete twist torsiune înșurubare

10x
Life



Manșon magnetic

Impact GOLD

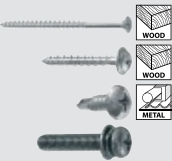

MAȘINI DE ÎNȘURUBAT



MAȘINI DE ÎNȘURUBAT CU IMPACT



Cheie tubulară



MAȘINI DE ÎNȘURUBAT CU IMPACT



direct

Extensie cheie tubulară

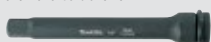

Cheie tubulară magnetică

1x
Life



Cheie tubulară cu inel

1x
Life **Impact GOLD**



Cheie tubulară detașabilă

20x
Life **Impact GOLD**



Bit înșurubare tijă filetată

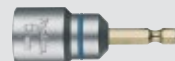

Cheie goală la interior

Pentru înșurubare tijă filetată



Adaptor cheie tubulară



Adaptor cheie tubulară flexibilă

15°
Life **Impact GOLD**



Impact

PREMIER

**ZONĂ DUBLĂ DE TORSIUNE
PENTRU REZISTENȚĂ MARE**



**ALIAJ DE OTEL
CREAT PENTRU CUPLURI MARI**

**VÂRF DE MARE PRECIZIE
SE FIXEAZĂ BINE ÎN ȘURUB**

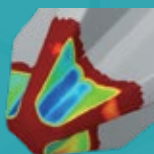

Afișare grafică a punctelor de contact



Impact
PREMIER

STANDARD

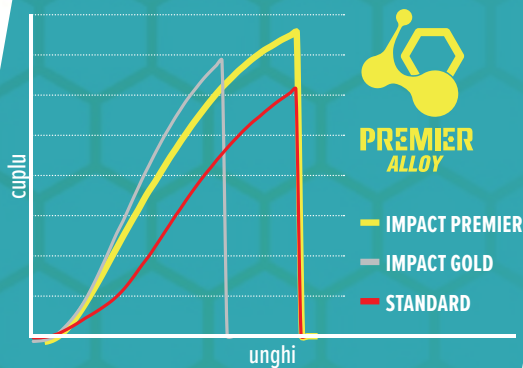

SERIE NOUĂ

BIȚI / TUBULARE / ADAPTOARE

BIȚI ȘI ADAPTOARE IMPACT PREMIER
**Impact
PREMIER**
Biți Impact Premier 25 mm

Cod	Lungime totală (mm)	Tip vârf	Tip	Prindere	Ambalare (buc./set)
E-03121	25	PH1	Torsiune	1/4"	2/1
E-03143	25	PH2	Torsiune superslim	1/4"	2/1
E-03246	25	PH2	Torsiune	1/4"	2/1
E-03137	25	PH2	Torsiune	1/4"	2/1
E-03159	25	PH3	Torsiune	1/4"	2/1
E-03165	25	PZ1	Torsiune	1/4"	2/1
E-03252	25	PZ2	Torsiune	1/4"	2/1
E-03171	25	PZ2	Torsiune	1/4"	2/1
E-03187	25	PZ3	Torsiune	1/4"	2/1
E-03193	25	T10	Torsiune	1/4"	2/1
E-03202	25	T15	Torsiune	1/4"	2/1
E-03218	25	T20	Torsiune	1/4"	2/1
E-03224	25	T25	Torsiune	1/4"	2/1
E-03230	25	T30	Torsiune	1/4"	2/1

Biți Impact Premier 50 mm
**Impact
PREMIER**

Cod	Lungime totală (mm)	Tip vârf	Tip	Prindere	Ambalare (buc./set)
E-03268	50	PH1	Zona dublă de torsiune	1/4"	2/1
E-03377	50	PH2	Zona dublă de torsiune	1/4"	10/1
E-03274	50	PH2	Zona dublă de torsiune	1/4"	2/1
E-03280	50	PH3	Zona dublă de torsiune	1/4"	2/1
E-03296	50	PZ1	Zona dublă de torsiune	1/4"	2/1
E-03383	50	PZ2	Zona dublă de torsiune	1/4"	10/1
E-03305	50	PZ2	Zona dublă de torsiune	1/4"	2/1
E-03311	50	PZ3	Zona dublă de torsiune	1/4"	2/1
E-03327	50	T10	Zona dublă de torsiune	1/4"	2/1
E-03333	50	T15	Zona dublă de torsiune	1/4"	2/1
E-03349	50	T20	Zona dublă de torsiune	1/4"	2/1
E-03355	50	T25	Zona dublă de torsiune	1/4"	2/1
E-03361	50	T30	Zona dublă de torsiune	1/4"	2/1











Biți Impact Premier cu vârf dublu

**Impact
PREMIER**

Cod	Lungime totală (mm)	Tip vârf	Tip	Prindere	Ambalare (buc./set)
E-06286	65	PH2-PH2	Zona dublă de torsiune	1/4"	2/1
E-06292	65	PZ2-PZ2	Zona dublă de torsiune	1/4"	2/1









Tubulare de impact Impact Premier

**Impact
PREMIER**

	Cod	Descriere	Lungime totală (mm)	Dimensiune (mm)	Tip	Prindere	Ambalare (buc./set)
	E-03458	Tubulară de impact H6 x 65	65	6	Magnetic	1/4"	1
	E-03464	Tubulară de impact H8 x 65	65	8	Magnetic	1/4"	1
	E-03470	Tubulară de impact H10 x 65	65	10	Magnetic	1/4"	1
	E-03486	Tubulară de impact H13 x 65	65	13	Magnetic	1/4"	1
	E-03492	Tubulară de impact H13 x 80	80	13	Magnetic	1/4"	1
	E-03501	Tubulară de impact H15 x 80	80	15	Magnetic	1/4"	1
	E-03517	Tubulară de impact H17 x 80	80	17	Magnetic	1/4"	1
	E-03523	Tubulară de impact H19 x 80	80	19	Magnetic	1/4"	1
	E-03539	Tubulară de impact H21 x 80	80	21	Magnetic	1/4"	1
	E-22888	Tubulară de impact cu inel reținere H8 x 50	50	8		1/4"	1
	E-22894	Tubulară de impact cu inel reținere H10 x 50	50	10		1/4"	1





Adaptoare și suporturi Impact Premier



	Cod	Descriere	Lungime totală (mm)	Prindere adaptor	Prindere	Ambalare (buc./set)
	E-03442	Suport magnetic pentru biți	/	/	/	1
	E-03420	Adaptor tubulare 50 mm SQ 3/8	50	SQ 3/8"	1/4"	1
	E-03436	Adaptor tubulare 50 mm SQ 1/2	50	SQ 1/2"	1/4"	1
	E-03399	Suport magnetic 68 mm	68	/	1/4"	1
	E-03414	Suport ultra magnetic 79 mm	79	/	1/4"	1
	E-03408	Suport magnetic 150 mm	150	/	1/4"	1
	E-20258	Suport magnetic 68 mm	68	/	1/4"	1
	E-20264	Suport magnetic 150 mm	150	/	1/4"	1
	E-20270	Suport ultra magnetic 79 mm	79	/	1/4"	1

Seturi Impact Premier



	Cod	Descriere	Conținut	Ambalare (buc./set)
	E-03567	Set 11 biți Impact Premier	25 mm: PH1, PH2, PH3, PZ1, PZ2, PZ3, T15, T20, T25, T30; adaptor 50 mm	1
	E-03573	Set 11 biți Impact Premier	25 mm: PH2, PZ1, 2xPZ2, PZ3, T20, T25, T30, SL4, SL6; adaptor 50 mm	1
	E-13552	Set 31 biți Impact Premier	25mm: PH1 / 5x PH2 / 2x PH3, PZ1 / 5x PZ2 / 2x PZ3, SL4 / SL6, T10 / T15 / 3x T20 / 2x T25 / 2x T30, H4 / H5 / H6	1
	E-25068	Set 28 de accesorii biți și tubulare Impact Premier	25 mm: 2xPH1 / 3x PH2 / 1x PH3, 2x PZ1 / 35x PZ2 / 12x PZ3, 1xT10 / 1xT15 / 3x T20 / 3x T25 / 2x T30, T40, Tubulare 8/10 mm, 2 adaptoare	1



BIȚI DE TORSIUNE IMPACT GOLD

Biți de torsiune Phillips (PH) Impact Gold

Puteți alege dintr-o gamă largă de biți Impact Gold cu lungimea de 25 sau 50 mm. Folosind un suport de impact biții Impact Gold au o durată de viață de 15 ori mai mare decât biții convenționali. Sunt alegerea perfectă pentru înșurubarea cu impact sau cuplu ridicat.



Impact GOLD
Xtreme Torsion Technology

Cod	Lungime totală (mm)	Tip șurub	Tip	Ambalare (buc./set)
B-28167	50	PH1	Torsiune magnetic	2/1

Biți de impact Impact Gold cu vârf dublu

Mașinile de înșurubat impact produc un cuplu ridicat care distruge biții convenționali. Vârfurile duble de înșurubat cu impact de la Makita sunt de 10 ori mai rezistente în comparație cu vârfurile convenționale.



Impact GOLD
Xtreme Torsion Technology

Cod	Lungime totală (mm)	Tip șurub	Prindere	Tip	Ambalare (buc./set)
B-52489	65	T20-T20	1/4"	Torsiune și magnetic	3/1
B-52495	65	T25-T25	1/4"	Torsiune și magnetic	3/1
B-52504	65	T25-T25	1/4"	Torsiune și magnetic	3/1
B-45272	150	PZ1	1/4"	Torsiune super subțire	1
B-45250	90	PZ2	1/4"	Torsiune super subțire	1
B-45288	150	PZ2	1/4"	Torsiune super subțire	1
B-45294	150	PZ3	1/4"	Torsiune super subțire	1
B-45238	65	PZ3	1/4"	Torsiune super subțire	3/1
B-45244	90	PZ1	1/4"	Torsiune super subțire	1
B-45266	65	PZ3	1/4"	Torsiune super subțire	1
B-45222	65	PZ2	1/4"	Torsiune super subțire	1
B-45216	65	PZ1	1/4"	Torsiune super subțire	1
B-45185	150	PH1	1/4"	Torsiune	1
B-45179	90	PH3	1/4"	Torsiune	1
B-45157	90	PH1	1/4"	Torsiune	1
B-45129	65	PH1	1/4"	Torsiune	3/1
B-45141	65	PH3	1/4"	Torsiune	3/1
B-45200	150	PH3	1/4"	Torsiune	1

IMPACT BLACK

SERIA NOUĂ DE BIȚI DE ÎNȘURUBARE / SUPORTURI / ADAPTOARE



Oțel durabil
pentru durată
de viață
extinsă



Tratat termic
pentru
durabilitate
mărită



Vârful de
precizie
previne
defectele

BIȚI PENTRU ÎNȘURUBARE

Bit de înșurubare cu torsiune

Biți de 25 mm fără magnet.



Ph Pz T



Suport magnetic pentru biți

60 mm



Bit de înșurubare magnetic cu torsiune

Biți magnetici de 50 mm.



Ph Pz T



Suport biți cu schimbare rapidă

60 mm



Tubulară magnetică

50 mm | 6,8, 10, 13 mm



Suport biți impact

80 mm



Adaptor soclu

50 mm 3/8" | 50 mm 1/2"



SETURI

IMPACT BLACK







BIȚI IMPACT BLACK
Biți Impact Black



Biți de torsiune Impact Black sunt cu 20% mai durabili decât biții convenționali.

IMPACT BLACK
 Impact driver's accessory series

Cod	Lungime totală (mm)	Tip șurub	Tip	Ambalare (buc./set)
B-63600	25	PH1	Torsiune	2/1
B-63616	25	PH2	Torsiune	2/1
B-63622	25	PH3	Torsiune	2/1
B-63638	25	PZ1	Torsiune	2/1
B-63644	25	PZ2	Torsiune	2/1
B-63650	25	PZ3	Torsiune	2/1
B-63666	25	T15	Torsiune	2/1
B-63672	25	T10	Torsiune	2/1
B-63688	25	T25	Torsiune	2/1
B-63694	25	T30	Torsiune	2/1
B-63703	25	T40	Torsiune	2/1
B-63719	50	PH1	Torsiune și magnetic	2/1
B-63725	50	PH2	Torsiune și magnetic	2/1
B-63731	50	PH3	Torsiune și magnetic	2/1
B-63747	50	PZ1	Torsiune și magnetic	2/1
B-63753	50	PZ2	Torsiune și magnetic	2/1
B-63769	50	PZ3	Torsiune și magnetic	2/1
B-63775	50	T15	Torsiune și magnetic	2/1
B-63781	50	T20	Torsiune și magnetic	2/1
B-63797	50	T25	Torsiune și magnetic	2/1
B-63806	50	T30	Torsiune și magnetic	2/1
B-63812	50	T40	Torsiune și magnetic	2/1

Adoptoare și suporturi Impact Black
IMPACT BLACK
 Impact driver's accessory series





	Cod	Descriere	Lungime totală (mm)	Prindere	Ambalare (buc./set)
	B-66793	Suport magnetic pentru biți	60	1/4"	1
	B-66802	Suport biți cu eliberare rapidă Impact Black	60	1/4"	1
	B-66868	Adaptor de impact 3/8 Impact Black	50	1/4"	1
	B-66874	Adaptor de impact 1/2 Impact Black	50	1/4"	1

	Cod	Descriere	Lungime totală (mm)	Prindere	Ambalare (buc./set)
	E-24125	Prelungitor biți Impact Black	76 mm	1/4"	1
	E-24131	Prelungitor biți Impact Black	152 mm	1/4"	1
	E-24147	Prelungitor biți Impact Black	304 mm	1/4"	1





Tubulare magnetice Impact Black





IMPACT BLACK
Impact driver's accessory series

	Cod	Lungime totală (mm)	Dimensiune tubulară	Prindere	Tip șurub	Tip	Ambalare (buc./set)
	B-66824	50	6 mm	1/4"	M3,5	Magnetic	1
	B-66830	50	8 mm	1/4"	M5	Magnetic	1
	B-66846	50	10 mm	1/4"	M6	Magnetic	1
	B-66852	50	13 mm	1/4"	M8	Magnetic	1

Seturi Impact Black

IMPACT BLACK
Impact driver's accessory series

	Cod	Descriere	Conținut set	Ambalare (buc./set)
	E-03109	Set pentru înșurubare Impact Black, 90 piese	Biți 25 mm: 5xPH1, 10xPH2, 5xPH3, 5xPZ1, 10xPZ2, 5xPZ3, 6xT15, 6xT20, 6xT25, 6xT30, Biți 50 mm: PH1, 4xPH2, 2xPH3, PZ1, 4xPZ2, 2xPZ3, 2xT15, 2xT20, 2xT25, 2xT30, SL0.8x5.5 mm / 2 chei tubulare 6, 8 mm / Suport magnetic	1
	E-03084	Set pentru înșurubare Impact Black in cutie tip acumulator, 31 piese	Biți 25 mm: 3xPH1, 3xPH2, 3xPH3 3xPZ1, 3xPZ2, 3xPZ3 3xT15, 3xT20, 3xT25, 3xT40, Suport magnetic	1
	E-11994	Set pentru înșurubare Impact Black, 8 piese	Biți 25 mm: PH1, 2x PH2, PH3, PZ1, PZ2, PZ3, Suport magnetic	1

	Cod	Descriere	Conținut set	Ambalare (buc./set)
	E-12011	Set pentru înșurubare Impact Black, 10 piese	Biți 50 mm: PH1, PH2, PH3, PZ1, PZ2, PZ3, T15, T20, T25, T30	1
	E-22925	Set mixt înșurubare Impact Black, 36 piese	Biți 25 mm: PH1, 4xPH2, PH3, PZ1, 3xPZ2, PZ3, T10, T15, 3xT20, 3xT25, 3xT30, 2xT40; Biți 50 mm: 2xPH2, PZ2, 2xT20, 2xT25, T30, adaptor magnetic, Tubulare: 8, 10, 13 mm	1
	E-12005	Set pentru înșurubare Impact Black, 1/4", 10 piese	Biți 25 mm: PH2, PZ2, T15, 2xT20, 2xT25, 2xT30, adaptor magnetic	1
	E-22850	Set 31 biți Impact Black în cutie tip acumulator XGT	-	1

BIȚI ÎNȘURUBARE

Biți Phillips (PH)



Cod	Lungime totală (mm)	Tip șurub	Tip	Prindere	Ambalare (buc./set)
P-06030	25	PH1	Torsiune	1/4"	10/1
P-06052	25	PH2	Torsiune	1/4"	10/1
P-06046	50	PH1	Torsiune	1/4"	10/1
P-06068	50	PH2	Torsiune	1/4"	10/1
P-06080	50	PH3	Torsiune	1/4"	10/1

Biți Phillips (PH)



Cod	Lungime totală (mm)	Tip șurub	Tip	Prindere	Ambalare (buc./set)
B-57788	90	PH2	Standard	1/4"	1/1
B-57794	90	PH3	Standard	1/4"	1/1
B-57847	150	PH2	Standard	1/4"	1/1
784261-7	25	PH2	Standard	1/4"	1/1

Biți Pozidrive (PZ)

DIN3126



Cod	Lungime totală (mm)	Tip șurub	Tip	Prindere	Ambalare (buc./set)
P-06096	25	PZ1	Torsiune	1/4"	10/1
P-06111	25	PZ2	Torsiune	1/4"	10/1
P-06133	25	PZ3	Torsiune	1/4"	10/1
P-06105	50	PZ1	Torsiune	1/4"	10/1
P-06127	50	PZ2	Torsiune	1/4"	10/1
P-06149	50	PZ3	Torsiune	1/4"	10/1

Biți Pozidrive (PZ)

DIN3126



Cod	Lungime totală (mm)	Tip șurub	Tip	Prindere	Ambalare (buc./set)
B-59885	90	PZ2	Standard	1/4"	1/1
B-59891	90	PZ3	Standard	1/4"	1/1
B-59950	150	PZ2	Standard	1/4"	1/1
B-59966	150	PZ3	Standard	1/4"	1/1

Biți TORX (T)

DIN3126



Cod	Lungime totală (mm)	Tip șurub	Tip	Prindere	Ambalare (buc./set)
P-06339	25	T15	Standard	1/4"	10/1
P-06345	25	T20	Standard	1/4"	10/1
P-06351	25	T25	Standard	1/4"	10/1
P-06367	25	T27	Standard	1/4"	10/1
P-06373	25	T30	Standard	1/4"	10/1
P-06389	25	T40	Standard	1/4"	10/1

Biți TORX (T)

DIN3126



Cod	Lungime totală (mm)	Tip șurub	Tip	Prindere	Ambalare (buc./set)
B-59900	90	T15	Standard	1/4"	1/1
B-59916	90	T20	Standard	1/4"	1/1
B-59922	90	T25	Standard	1/4"	1/1
B-59938	90	T30	Standard	1/4"	1/1
B-59972	150	T15	Standard	1/4"	1/1

Cod	Lungime totală (mm)	Tip șurub	Tip	Prindere	Ambalare (buc./set)
B-59988	150	T20	Standard	1/4"	1/1
B-59994	150	T25	Standard	1/4"	1/1
B-60006	150	T30	Standard	1/4"	1/1

Biți cu profil pătrat (SQ)



Cod	Lungime totală (mm)	Tip șurub	Tip	Prindere	Ambalare (buc./set)
B-57803	90	SQ1	Magnetic	1/4"	1/1
B-57819	90	SQ2	Magnetic	1/4"	1/1
B-57825	90	SQ3	Magnetic	1/4"	1/1
B-57869	150	SQ1	Magnetic	1/4"	1/1
B-57875	150	SQ2	Magnetic	1/4"	1/1
B-57881	150	SQ3	Magnetic	1/4"	1/1

Biți dubli de înșurubare (PH, PZ)







Mașinile de înșurubat cu impact produc un cuplu ridicat ce distruge vârfurile de înșurubat convenționale. Bitul cu cap dublu Makita durează de până la 10 ori mai mult decât vârfurile convenționale.



Cod	Lungime totală (mm)	Tip șurub	Tip	Prindere	Ambalare (buc./set)
B-12326	85	PH2	Torsiune	1/4"	3/1
B-12790	85	PZ2	Torsiune	1/4"	3/1
B-16259	85	PZ2	Torsiune	1/4"	18/1

ADAPTOARE ȘI SUPORTURI

	Cod	Descriere	Lungime totală (mm)	Prindere	Ambalare (buc./set)
	P-05985	Suport pentru biți cu magnet permanent	75	1/4"	1
	P-38906	Adaptor înșurubare pentru burghie beton, verde 6 mm	75	1/4"	1
	P-38928	Adaptor înșurubare pentru burghie beton, albastru 10 mm	80	1/4"	1
	784811-8	Suport pentru biți cu magnet permanent	60	1/4"	1
	B-52445	Suport pentru biți cu magnet permanent	60	1/4"	1
	B-52934	Suport de biți 120mm - transparent	120	1/4"	1

	Cod	Descriere	Lungime totală (mm)	Prindere	Ambalare (buc./set)
	D-74740	Adaptor SQ 1/4" pentru tubulare	50	1/4"	1
	B-57738	Adaptor SQ 3/8" pentru tubulare	150	1/4"	1
	B-57744	Adaptor SQ 1/2" pentru tubulare	150	1/4"	1
	B-57750	Suport magnetic lung	150	1/4"	1
	B-29094	Suport flexibil pentru biți	300	1/4"	1
	B-51867	Bit prelungitor flexibil impact	300	1/4"	1
	B-57766	Suport magnetic lung	300	1/4"	1

TUBULARE

Tubulare



Cod	Lungime totală (mm)	Dimensiune tubulară	Tip	Prindere	Ambalare (buc./set)
P-06270	55	5,5	Standard	1/4"	1
P-06286	55	7	Standard	1/4"	1
P-06292	55	8	Standard	1/4"	1
P-06301	55	10	Standard	1/4"	1
P-06317	55	13	Standard	1/4"	1

Tubulare magnetice

Un instrument excelent pentru diferite tipuri de aplicații. O cheie magnetică plug-in este utilizată în mod obișnuit pentru a atașa șuruburi hexagonale. Magnetul ține ferm capul șurubului și previne alunecarea, ceea ce este important pentru lucrările la înălțime și lucrările cu o singură mână.

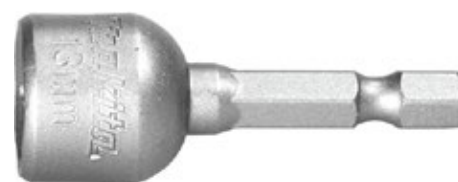

Cod	Lungime totală (mm)	Dimensiune tubulară	Tip șurub	Tip	Prindere	Ambalare (buc./set)
B-38700	50	7 mm	M4	Magnetic	1/4"	1
B-38912	50	6 mm	M3,5	Magnetic	1/4"	1
B-38928	50	7 mm	M4	Magnetic	1/4"	1
B-38934	50	8 mm	M5	Magnetic	1/4"	1
B-38940	50	10 mm	M6	Magnetic	1/4"	1
B-38956	50	12 mm	M8	Magnetic	1/4"	1
B-38962	50	13 mm	M8	Magnetic	1/4"	1
B-38978	50	17 mm	M10	Magnetic	1/4"	1
B-39176	50	6, 8, 10, 12, 13 mm		Magnetic	1/4"	5/1
B-57554	50	8, 10, 12, 13 mm		Magnetic	1/4"	4/1

Tubulare goale

Cheile tubulare goale scurtează timpul de strângere a piulițelor de pe tije filetate comparativ cu strângerea manuală.



Cod	Lungime totală (mm)	Dimensiune tubulară	Tip șurub	Ambalare (buc./set)
B-52526	75	10	1/4"	1
B-52532	150	10	1/4"	1
B-52548	300	10	1/4"	1
B-52560	700	10	1/4"	1
B-52576	75	13	1/4"	1
B-52582	150	13	1/4"	1
B-52598	300	13	1/4"	1
B-52613	700	13	1/4"	1
B-52629	75	17	1/4"	1
B-52635	150	17	1/4"	1
B-52641	300	17	1/4"	1
B-52663	700	17	1/4"	1

Chei tubulare cu bacuri pentru tije filetate

Tije filetate sunt adesea folosite pentru a atășa sisteme de aer condiționat, lumini, conducte și cabluri de tavan sau perete. Tubularele pentru tije filetate reduc semnificativ timpul și efortul în instalarea tijelor filetate comparativ cu instalarea manuală.





Cod	Descriere	Lungime (mm)	Tip tijă	Prindere	Ambalare (buc./set)
B-42961	Cheie soclu pentru tije filetate	66	M6	1/4"	1
B-42977	Cheie soclu pentru tije filetate	66	M8	1/4"	1
B-42983	Cheie soclu pentru tije filetate	66	M10	1/4"	1
B-42999	Set 3 chei tubulare pentru tije filetate	66	M6, M8, M10	1/4"	1

Bit pentru gips-carton



Cod	Descriere	Tip șurub	Lungime (mm)	Ambalare (buc./set)
D-61690	Bit formă tip C pentru gips-carton	PH2	30	1
B-60399	Bit pentru înșurubat în gips-carton	PH2	40	1

SETURI DE ÎNȘURUBARE

Cod	Nr. piese în set	Tip biți							Adaptoare	Chei tubulare	Scule de mână
		PH		PZ		TORX		HEX			
D-73265	7	✓							✓	✓	
D-73271	7	✓		✓					✓	✓	
P-16782	10	✓		✓		✓			✓	✓	
D-30651	11	✓		✓		✓			✓	✓	
B-49921	26	✓		✓		✓			✓	✓	
E-15774	30	✓		✓		✓			✓	✓	
D-30667	31	✓		✓		✓			✓	✓	
E-00016	31	✓		✓		✓	✓		✓	✓	
D-65084	32	✓		✓		✓	✓		✓	✓	
D-74762	32	✓		✓		✓			✓	✓	
B-57015	38	✓		✓		✓	✓			✓	
E-10899	76	✓		✓		✓			✓	✓	✓
E-08458	87	✓		✓		✓	✓		✓	✓	✓
E-06616	120	✓		✓		✓	✓		✓	✓	✓
E-08713	120	✓		✓		✓	✓		✓	✓	✓
E-10883	221	✓		✓		✓	✓		✓	✓	✓

D-73265



D-73271



P-16782



D-30651



B-49921



E-15774



D-30667



E-00016



D-65084



D-74762



B-57015



E-10899



E-08458



E-06616



E-08713



E-10883



ALTE ACCESORII

B-69917

Cutie depozitare accesorii în formă de acumulator

1

ACCESORII PENTRU MAȘINI DE ÎNȘURUBAT**Biți Phillips (PH) pentru mașini de înșurubat șuruburi în bandă**

Cod	Lungime totală (mm)	Tip șurub	Diametru (mm)	Prindere	Compatibil cu	Ambalare (buc./set)
P-13568	127	PH2	6	1/4"	6832, 6833, 6835DWA	10/1
P-67795	157	PH2	5	1/4"	6842, DFR550	3/1
P-21593	141	PH2	6	1/4"		10/1
P-13574	110	PZ2	6	1/4"		10/1

Biți Pozidrive (PZ) pentru mașini de înșurubat șuruburi în bandă

Cod	Lungime totală (mm)	Tip șurub	Diametru (mm)	Prindere	Compatibil cu	Ambalare (buc./set)
P-13580	127	PZ2	6	1/4"	6835DWA	10/1

Șuruburi în bandă pentru rigips

	Cod	Descriere	Tip șurub	Lungime (mm)	Diametru șurub (mm)	Potrivit pentru	Ambalare (buc./set)
	F-30913	Bandă șuruburi autofiletate, acoperite cu fosfat	PH2	25 mm	3,9	Placaj și structuri de lemn	1000/1
	F-30926	Bandă șuruburi autofiletate, acoperite cu fosfat	PH2	30 mm	3,9	Placaj și structuri de lemn	1000/1
	F-30942	Bandă șuruburi autofiletate, inox	PH2	55 mm	3,9	Placaj și structuri de lemn	1000/1
	F-31153	Bandă șuruburi autofiletate, acoperite cu fosfat	PH2	35 mm	3,9	Placaj și structuri de lemn	1000/1
	F-31179	Bandă șuruburi autofiletate, acoperite cu fosfat	PH2	35 mm	3,9	Placaj și structuri de lemn	1000/1
	F-31182	Bandă șuruburi autofiletate, acoperite cu fosfat	PH2	41 mm	3,9	Placaj și structuri de lemn	1000/1

Atașament alimentare șuruburi



Cod	Descriere	Lungimea șurubului (mm)	Compatibil cu	Ambalare (buc./set)
195184-8	Atașament alimentare șuruburi	25-55	6842, 6843, DFR540, DFR550	1



Atașament alimentare șuruburi și biți



Cod	Descriere	Lungimea șurubului (mm)	Prindere	Compatibil cu	Ambalare (buc./set)
199155-7	Bit înșurubare PH2 pentru alimentator DFS	130	PH2	DFS452, DFS451, DFS250, FS6300, FS6200, FS4300, FS4200, FS4000, FS2300, FS2200	5/1
191L24-0	Bit înșurubare PH2 pentru alimentator DFS	25-55	PH2	DFS250, DFS452, FS2300, FS4300, FS6300, FS4300, FS4200, FS4000, FS2300	1

Atașamente pentru centrare



	Cod	Descriere	Compatibil cu	Ambalare (buc./set)
	197024-6	Limitator de adâncime ce poate fi folosit în combinație cu adaptorul de 76 mm.	DFS452, DFS451, FS2300, FS4000, FS4300, FS6300R	1
	197025-4	Limitator de adâncime ce poate fi folosit în combinație cu adaptorul de 60 mm.	DFS452, DFS451, FS2300, FS4000, FS4300, FS6300R	1
	122450-0	Limitator de adâncime	6820V	1
	322069-7	Bucșă de ghidare (Φ 15,5 mm x 45 mm)	6827, FS2700	1
	322120-3	Bucșă de ghidare 50 mm (Φ 12 mm x 45 mm)	6805BV, 6827, FS2700	1

ACCESORII PENTRU MAȘINI DE ÎNȘURUBAT CU IMPACT

Chei tubulare impact CR-MO 1"



Cod	Lungime totală (mm)	Dimensiune cheie	Prindere	Ambalare (buc./set)
E-24549	63	33	1"	1
E-24555	63	34	1"	1
E-24583	66	40	1"	1
E-24599	68	41	1"	1
E-24614	70	44	1"	1
E-24636	76	50	1"	1
E-24642	84	55	1"	1
E-24658	88	60	1"	1
E-24664	92	65	1"	1
E-24670	96	70	1"	1
E-24717	90	33	1"	1
E-24723	90	34	1"	1
E-24751	90	40	1"	1
E-24767	90	44	1"	1
E-24789	100	50	1"	1
E-24795	108	55	1"	1
E-24804	108	60	1"	1
E-24810	120	65	1"	1

Chei tubulare impact scurte CR-MO 1"



Cod	Lungime totală (mm)	Dimensiune cheie	Prindere	Ambalare (buc./set)
E-24511	60	27	1"	1
E-24527	62	30	1"	1
E-24533	63	32	1"	1
E-24561	66	36	1"	1
E-24577	66	38	1"	1
E-24608	68	42	1"	1
E-24620	72	46	1"	1

Chei tubulare impact adânci CR-MO 1"

Cod	Lungime totală (mm)	Dimensiune cheie	Prindere	Ambalare (buc./set)
E-24686	90	27	1"	1
E-24692	90	30	1"	1
E-24701	90	32	1"	1
E-24739	90	36	1"	1
E-24745	90	38	1"	1
E-22420	90	41	1"	1
E-24773	100	46	1"	1

Chei tubulare impact CR-MO 1/2"

Cod	Lungime totală (mm)	Dimensiune cheie	Tip șurub	Prindere	Ambalare (buc./set)
134825-1	38	13	M8	1/2"	1
134827-7	52	13	M8	1/2"	1
134829-3	38	17	M10	1/2"	1
134830-8	52	17	M10	1/2"	1
134831-6	38	19	M12	1/2"	1
134833-2	52	21	M14	1/2"	1
134851-0	38	22	M14	1/2"	1
134836-6	52	24	M16	1/2"	1
134844-7	50	27	M18	1/2"	1
134845-5	75	27	M18	1/2"	1
134846-3	50	30	M20	1/2"	1
134847-1	78	30	M20	1/2"	1
134849-7	78	32	M22	1/2"	1

Chei tubulare impact adânci CR-MO 1/2"

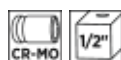

Cod	Lungime totală (mm)	Dimensiune cheie	Prindere	Ambalare (buc./set)
E-16405	81.5	8	1/2"	1
E-16411	81.5	10	1/2"	1
E-16449	81.5	13	1/2"	1
E-16477	81.5	17	1/2"	1
E-16499	81.5	19	1/2"	1
E-16508	81.5	21	1/2"	1
E-16536	81.5	27	1/2"	1
E-16542	81.5	30	1/2"	1
E-16558	81.5	32	1/2"	1
E-16570	38	8 - 10 - 12 - 13 - 14 - 16 - 17 - 19 - 21	1/2"	1
E-16586	81.5	10 - 11 - 12 - 13 - 14 - 16 - 17 - 19 - 21 - 22 - 24 - 27 - 30 - 32	1/2"	1
E-16601	38	8 - 10 - 12 - 13 - 14 - 17 - 19 - 21	1/2"	1

Chei tubulare impact CR-MO 3/4"

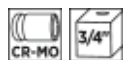

Cod	Lungime totală (mm)	Dimensiune cheie	Tip șurub	Prindere	Ambalare (buc./set)
A-85494	50	17	M10	3/4"	1
A-85519	50	19	M12	3/4"	1
A-85553	52	22	M14	3/4"	1
A-85575	52	24	M16	3/4"	1
134853-6	52	26	M16	3/4"	1
134854-4	95	26	M16	3/4"	1
134855-2	52	27	M18	3/4"	1
134856-0	95	27	M18	3/4"	1
134857-8	52	30	M20	3/4"	1
134858-6	95	30	M20	3/4"	1
134859-4	95	32	M22	3/4"	1
134871-4	52	32	M22	3/4"	1
134860-9	56	35	7/8"	3/4"	1
134861-7	95	35	7/8"	3/4"	1
134862-5	59	36	M24	3/4"	1
134863-3	95	36	M24	3/4"	1

Chei tubulare impact CR-MO 3/4"

Cod	Lungime totală (mm)	Dimensiune cheie	Prindere	Ambalare (buc./set)
E-22224	51	17	3/4"	1
E-22230	51	19	3/4"	1
E-22246	51	21	3/4"	1
E-22252	51	22	3/4"	1
E-22268	51	24	3/4"	1
E-22280	53	27	3/4"	1
E-22296	53	30	3/4"	1
E-22305	57	32	3/4"	1
E-22327	57	36	3/4"	1

Chei tubulare impact adânci CR-MO 3/4"

Cod	Lungime totală (mm)	Dimensiune cheie	Prindere	Ambalare (buc./set)
E-22333	90	19	3/4"	1
E-22349	90	21	3/4"	1
E-22355	90	24	3/4"	1
E-22361	90	27	3/4"	1
E-22377	90	30	3/4"	1
E-22383	90	32	3/4"	1
E-22399	90	36	3/4"	1

Chei tubulare impact adânci CR-MO 3/4"

Cod	Lungime totală (mm)	Dimensiune cheie	Prindere	Ambalare (buc./set)
A-85503	95	17	3/4"	1
A-85525	95	19	3/4"	1
A-85531	52	21	3/4"	1
A-85547	95	21	3/4"	1
A-85569	95	22	3/4"	1
A-85581	95	24	3/4"	1

Chei tubulare impact TORX 1/2"



Cod	Lungime totală (mm)	Dimensiune cheie	Prindere	Ambalare (buc./set)
E-19819	78	T40	1/2"	1
E-23628	78	T30, T40, T45, T50, T55, T60, T70	1/2"	1

Chei tubulare impact CR-MO fără inel O 3/8"



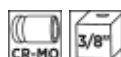

Tuburile Cr-Mo sunt ideale pentru mașini de înșurubat cu impact cu acumulatori. Materialul din care sunt fabricate este extrem de durabil și rezistent la cuplu mare.



Cod	Lungime totală (mm)	Dimensiune cheie	Prindere	Ambalare (buc./set)
B-39958	28	13	3/8"	1
B-39964	28	14	3/8"	1
B-39986	28	16	3/8"	1
B-40004	30	18	3/8"	1
B-40010	30	19	3/8"	1
B-40026	30	20	3/8"	1
B-40032	30	21	3/8"	1
B-40048	30	22	3/8"	1

Seturi de chei tubulare

Sunt folosite pentru înșurubarea șuruburilor și piulițelor cu ajutorul mașinilor de înșurubat cu impact.

	Cod	Descriere	Dimensiune cheie	Prindere	Ambalare (buc./set)
	E-02989	Set 8 tubulare impact în rolă textilă	8, 10, 12, 13, 14, 17, 19, 21 mm	1/2"	1
	E-12289	Set tubulare impact cu adaptor, 9 piese	6,7,8,10,11,12,13 mm, adaptor 1/4"	1/4"	1
	B-54651	Set tubulare impact cu adaptor, 9 piese	8, 10, 12, 13, 14, 15, 17, 18 mm, adaptor 3/8"	3/8"	1
	B-66232	Set 9 tubulare de impact 1/2	8, 10, 12, 13, 14, 16, 17, 19, 21 mm	1/2"	1

Extensii și adaptoare







































	Cod	Descriere	Lungime totală (mm)	Prindere	Ambalare (buc./set)
	134870-6	Extensie	200	1"	1
	134873-0	Adaptor de la 1/2 la 1/4	50	1/2"	1
	134874-8	Extensie	100	1/2"	1
	134877-2	Adaptor cu articulație universală cardanică	84	1/2"	1
	134998-0	Adaptor cu articulație universală cardanică	105.5	3/4"	1
	134997-2	Extensie	150	3/4"	1
	B-55706	Extensie SQ 1/2, 250mm	250	1/2"	1
	B-55712	Extensie SQ 1/2, 150mm	150	1/2"	1
	B-55728	Extensie SQ 1/2, 75mm	75	1/2"	1
	B-68448	Adaptor de la 1/2 la 1/4	50	1/2"	1
	B-68460	Adaptor de la 1/2 la 7/16	50	1/2"	1
	P-05941	Adaptor de 1/2 la 1/4	50	1/2"	1
	P-05963	Adaptor de la 3/8 la 1/4	55	3/8"	1

Pini și inele



Cod	Descriere	Ambalare (buc./set)
B-54592	Pin tubulare 1/2" 17 mm	3/1
B-54586	Pin tubulare 1/2" 8-16 mm	3/1
B-54601	Pin tubulare 1/2" 18-19 mm	3/1
B-54617	Pin tubulare 1/2" 20-32 mm	3/1
B-54542	Inel O tubulare 1/2" 8-16 mm	3/1
B-54558	Inel O tubulare 1/2" 17 mm	3/1
B-54564	Inel O tubulare 1/2" 18-19 mm	3/1
B-54570	Inel O tubulare 1/2" 20-32 mm	3/1
E-22408	Inel O tubulare 3/4" 17-36 mm	1/1
E-22414	Pin tubulare 3/4" 17-36 mm	1/1
E-22436	Inel O tubulare 1" 27-70 mm	1/1
E-22442	Pin tubulare 1" 27-70 mm	1/1

ACCESORII PENTRU DEBITARE DIAMANTATĂ ȘI POLIZARE

Marmură		Piatră naturală	
Beton		Beton armat	
Piatră de calcar		Cărămidă	
Zidărie		Beton poros	
Cărămidă zidită		Acoperiș de țiglă	
Sticlă		Ardezie moale	
Asfalt		Fibră de sticlă	
Aluminiu		Oțel inoxidabil	
Metal		Metale neferoase	
Materiale epoxidice		Plastic	
Lemn		Lemn cu cuie	
		Plăci ceramice	
		Curățare vopsea de pe metal	
		Oxid de aluminiu	
		Oxid ceramic de aluminiu	
		Carbură de siliciu	
		Aluminiu zirconiu	
		Polizare în unghi de 30°	
		Tăiere în unghi drept 90°	
		Utilizare umedă	
		Utilizare uscată	
		Polizor unghiular cu acumulatori	
		Industrie - șantier naval	
		Industrie - platformă petrolieră	
		Disc flexibil	
		Suport pad	
		Echipament de protecție	
		Durată lungă de utilizare	



DISCURI DIAMANTATE



QUASAR

Discuri diamantate profesionale 3DDG de uz universal. Grație tehnologiei Stealth discurile diminuează vibrațiile și zgomotul. Potrivit pentru tăiere în mediu uscat și umed.



COMET

Discuri diamantate profesionale 3DDG. O parte a discului dispune de tehnologie Stealth care reduce vibrațiile și zgomotul. Tăieturi rapide și curate.



NEBULA

Discuri diamantate 3DDG, cu segmenti realizați prin tehnologie laser. Pentru tăiere în mediu uscat și umed.



TEHNOLOGIA 3DDG

Pentru tăiere rapidă și durată de viață extinsă

Tehnologia de fabricație inovativă permite distribuția tridimensională și uniformă a particulelor de diamant, conform unui model prestabilit pentru o durată de viață extinsă și viteză de lucru.



TEHNOLOGIA STEALTH

Pentru vibrații reduse și zgomot redus

Tehnologie inovatoare care reduce vibrațiile și poluarea fonică, aspect foarte important când se lucrează în zone care solicită acest lucru. Lame stabile care asigură tăiere rapidă și curate.

MATERIALE	QUASAR	COMET	NEBULA
Granit	◆◆	◆◆	◆
Clincher dur	◆◆	◆◆	◆
Argilă dură	◆◆◆◆	◆◆◆◆	◆
Pavele	◆◆◆◆	◆◆◆◆	◆
Țevi de argilă	◆◆◆◆◆	◆◆◆◆◆	◆
Piatră dură	◆◆◆◆◆	◆◆◆◆◆	◆
Plăci de argilă	◆◆◆◆◆	◆◆◆◆◆	◆
Piatră de duritate medie	◆◆◆◆◆	◆◆◆◆◆	◆◆
Ardezie	◆◆◆◆◆	◆◆◆◆◆	◆◆
Plăci Teraco	◆◆◆◆◆	◆◆◆◆◆	◆◆
Beton armat	◆◆◆◆◆	◆◆◆◆◆	◆◆◆◆
Calcar	◆◆◆◆◆	◆◆◆◆◆	◆◆◆◆
Pane beton	◆◆◆◆◆	◆◆◆◆◆	◆◆◆◆
Borduri beton	◆◆◆◆◆	◆◆◆◆◆	◆◆◆◆
Plăci de beton spălat	◆◆◆◆◆	◆◆◆◆	◆◆◆◆
Rafturi din beton	◆◆◆◆◆	◆◆◆◆	◆◆◆◆
Bolțari	◆◆◆◆◆	◆◆◆◆	◆◆◆◆
Pietre duritate scăzută	◆◆◆◆◆	◆◆	◆◆
Ardezie moale	◆◆◆◆◆	◆◆	◆◆
Țiglă beton	◆◆◆◆	◆◆	◆◆
Gresie dură	◆◆◆◆	◆	◆
Gresie moale	◆◆	◆	◆
Șapă	◆◆	◆	◆
Asfalt	◆◆	◆	◆

SIMBOLISTICĂ

Tipul materialului:
DS: Diamond Segment
DC: Diamond Continuous
DA: Diamond Asphalt

Diametru placă (mm)

Diametru gaură (mm)

Tipul plăcii:
Q: Quasar C: Comet
N: Nebula L: Laser

Q DS 300 22 XS

Caracteristici speciale:
C: cu orificii de aerisire
V: cu partea de mijloc mai groasă
X: structură diamantată 3D
S: tehnologie Stealth

DISCURI DIAMANTATE

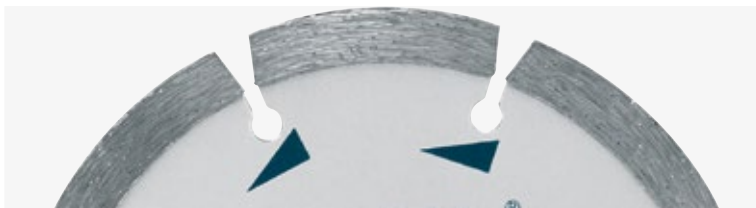

SEGMENTAT

Disc prevăzut cu creștături și particule de diamant pe segmente. Discurile diamantate segmentate asigură o tăiere mai rapidă decât cele standard, de calitate peste medie.



CU SEGMENTE ÎNDULĂȚI

Discurile prezintă creștături ondulate care asigură o tăiere mai rapidă, rezistență mai mică și îndepărtare rapidă a materialului prelucrat.

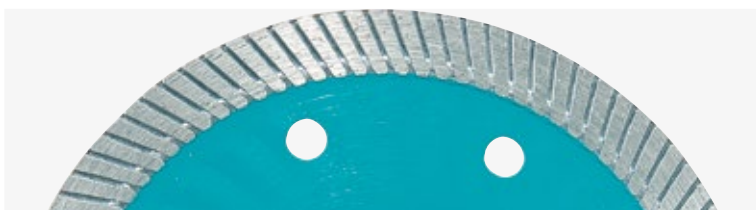

ONDULAT

Discurile prezintă creștături. Combinație între tipul continuu și cel segmentat pentru tăieri rapide și curate. Tăiere mai rapidă decât în cazul discurilor segmentate. Se pot obține tăieturi mai curate decât cu tipul continuu, nesegmentat.



CONTINUU

Strat uniform de diamante dispus pe întreaga suprafață a segmentului pentru tăieri de precizie în materiale fragile. Precizie de tăiere mai mare la viteze mai mici decât în cazul discurilor segmentate.

DISCURI DIAMANTATE - SPECIALIZATE



GALVANIZATE

Aplicarea particulelor de diamant este efectuată cu electrozi, având o dispunere mai mare decât în cazul procedurii obișnuite. Asigură tăiere rapidă și eficientă.



CU PARTICULE DE DIAMANT APLICATE ÎN VACUUM

Aplicarea particulelor de diamant este efectuată în vacuum, având o dispunere mai mare decât în cazul procedurii obișnuite. Discurile realizate cu această tehnologie au o durată de viață mai mare decât cele galvanizate. Destinate tăierii materialelor dure.

CLASE DE CALITATE

DISCURI DE CALITATE ÎNALTĂ

★★★

Performanță maximă în raportul dintre viteza de tăiere și durabilitate.

CALITATE STANDARD

★★

Raport excelent eficacitate preț.

DISCURI ECONOMICE

★

Prețuri deosebit de atractive.

DISCURI DIAMANTATE

Ideale pentru mașinile cu acumulatori



PENTRU PLĂCI CERAMICE



1. Ideale pentru mașinile cu acumulatori

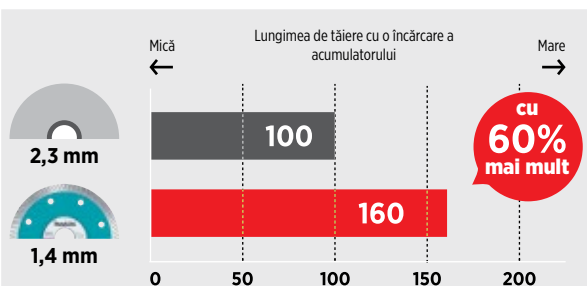

NOTĂ DE SUBSOL:

1. Rezultatele testelor depind de diverși factori
2. Valorile din grafic sunt relative când capacitatea discului diamantat Makita (grosime 2,3 mm) este indexată cu 100.

2. Lamă mai subțire - tăiere lină și ușoară



PENTRU GRANIT, BETON ȘI MARMURĂ

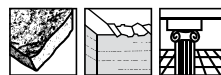

1. Ideale pentru mașinile cu acumulatori

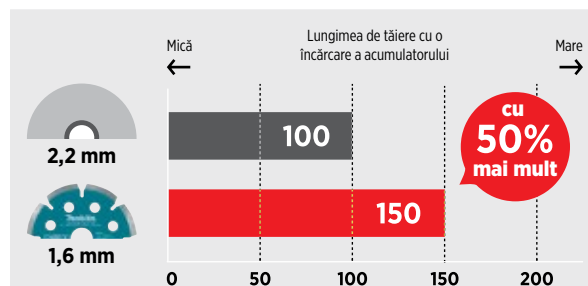

NOTĂ DE SUBSOL:

1. Rezultatele testelor depind de diverși factori
2. Valorile din grafic sunt relative când capacitatea discului diamantat Makita (grosime 2,3 mm) este indexată cu 100.

2. Lamă subțire și greutate redusă

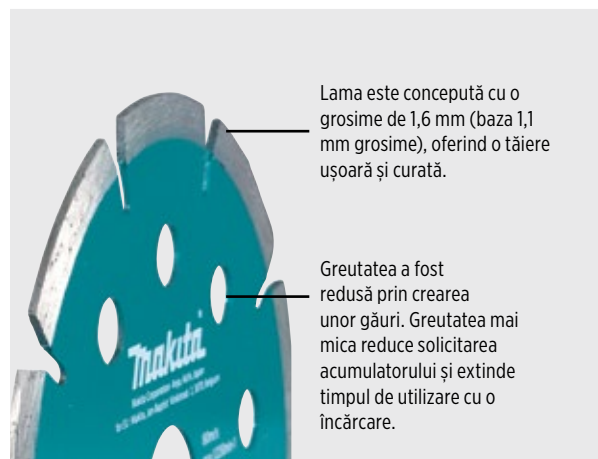

DISCURI TĂIERE DIAMANTATĂ
Discuri diamantate segmentate Premium Quasar Stealth, 3DDG

Discuri de tăiere premium ce au o aranjare 3D a particulelor diamantate 3DDG pentru uz profesional. Tăișul segmentelor diamantate au forma literei M și o lungime utilă de 12 mm. Tehnologia inovatoare Stealth reduce vibrațiile și zgomotul. Discurile pot fi folosite pentru tăiere umedă și uscată. Sunt potrivite pentru tăiere: marmură, granit, beton armat, beton, cărămizi medii și dure, plăci de piatră, plăci ceramice și ardezie.



Cod	Cod ID Makita	Diametru (mm)	Alezaj (mm)	Înălțime segment (mm)	Descriere	Turație maximă (min ⁻¹)	Ambalare (buc./set)
B-12712	QDS23022XS	230	22,23	12	3DDG, Stealth	6.650	1
B-13465	QDS35025XS	350	25,4/20	12	3DDG, Stealth	5.500	1
B-13471	QDS40025XS	400	25,4/20	12	3DDG, Stealth	4.770	1

Discuri universale segmentate, Comet

Discuri diamantate profesionale 3DDG. O parte a discului dispune de tehnologia Stealth care reduce vibrațiile și zgomotul. Tăieri rapide și curate.



Cod	Cod ID Makita	Diametru (mm)	Alezaj (mm)	Înălțime segment (mm)	Descriere	Turație maximă (min ⁻¹)	Ambalare (buc./set)
B-12762	CDS11522RC	115	22,23	10	3DDG, orificii răcire	13.300	1
B-12778	CDS12522RC	125	22,23/20	10	3DDG, orificii răcire	12.250	1
B-13546	CDS30020RCX	300	20	10	3DDG, orificii răcire	6.400	1
B-13552	CDS35025RCX	350	25,4/20	10	3DDG, orificii răcire	5.550	1
B-13568	CDS40025RCX	400	25,4/20	10	3DDG, orificii răcire	5.550	1

Discuri diamantate ondulate Comet Turbo

Cod	Cod ID Makita	Diametru (mm)	Alezaj (mm)	Înălțime segment (mm)	Descriere	Ambalare (buc./set)
B-12980	CTD11522	115	22,23	7	Disc Turbo	1
B-12996	CTD12522	125	22,23/20	7	Turbo	1
B-13013	CTD17522	180	22,23	7	Disc Turbo	1



Discuri diamantate pentru asfalt Comet 3DDG

Discuri diamantate profesionale 3DDG. O parte a discului dispune de tehnologia Stealth care reduce vibrațiile și zgomotul. Tăieri rapide și curate.



Cod	Cod ID Makita	Diametru (mm)	Alezaj (mm)	Înălțime segment (mm)	Descriere	Turație maximă (min ⁻¹)	Ambalare (buc./set)
B-13269	CDA30020	300	20	10	3DDG, Asfalt	6.360	1
B-13275	CDA35025	350	25,4/20	10	3DDG, Asfalt	5.500	1

Discuri diamantate continue Comet

Particulele diamantate sunt așezate în strat cu grosime constantă de-a lungul întregii margini a discului, ceea ce asigură tăieri netede și curate în materiale casante. Tăierea este mai precisă la viteze mai mici comparativ cu discurile de tăiere segmentate. Recomandate pentru tăierea plăcilor ceramice și porțelanului.



Cod	Cod ID Makita	Diametru (mm)	Alezaj (mm)	Înălțime segment (mm)	Descriere	Ambalare (buc./set)
B-13063	CDC8015	80	15	5	Disc continuu	1
B-13091	CDC12522	125	22,23	5	Disc continuu	1
B-13122	CDC20030	200	30/25,4	5	Disc continuu	1







Discuri diamantate segmentate Nebula laser





Potrivit pentru tăiere umedă și uscată, pentru tăierea materialelor de construcții (zidărie, quart, calcar).



Cod	Cod ID Makita	Diametru (mm)	Alezaj (mm)	Descriere	Ambalare (buc./set)
B-53986	115	22,23	10	Disc sudat laser	1
B-53992	125	22,23	10	Disc sudat laser	1
B-54025	230	22,23	10	Disc sudat laser	1
B-54031	300	20	10	Disc sudat laser	1
B-54053	350	25,4	10	Disc sudat laser	1
B-54069	400	25,4	10	Disc sudat laser	1

Materiale

Material Nr. 1						
Beton dur	Granit	Piatră naturală gneiss	Pavaje diverse			Cărămidă clasa 2
						

Material Nr. 2				Material Nr. 3		
Beton	Bolțari de ciment	Canale tip U	Dale	Țiglă ceramică	Țiglă cimentată	Țiglă argilă
						

Material Nr. 4		Material Nr. 5		Material Nr. 6	Material Nr. 7
Cărămidă	Agregate	Țiglă franțuzească	Asfalt	Plăci ceramice	Sticlă
					

Discuri diamantate segmentate pentru beton X-LOCK

Sistemul X-LOCK permite montarea și demontarea discului fără alte unelte și previne suprastrângerea discului.



Cod	Diametru (mm)	Alezaj (mm)	Înălțime segment (mm)	Ambalare (buc./set)	Material	Tip tăiere	Gamă
E-02076	125	X-LOCK	7	1	1 2 3 4	Uscată	★★★★☆

Discuri diamantate segmentate pentru beton

Cod	Diametru (mm)	Alezaj (mm)	Înălțime segment (mm)	Ambalare (buc./set)	Material	Tip tăiere	Gamă
D-41610	230	22,23	7.5	1	2	Uscată	★★★★☆
A-84109	115	22,23	7.75	1	2 3 4 5	Uscată	★★★★☆
D-41595	125	22,23	7.5	1	2	Uscată	★★★★☆
A-84137	230	22,23	7.5	1	2 3 4 5	Uscată	★★★★☆



Discuri diamantate segmentate pentru beton, marmură



Cod	Diametru (mm)	Alezaj (mm)	Înălțime segment (mm)	Ambalare (buc./set)	Material	Tip tăiere	Gamă
D-52766	125	22,23	7	1	Beton, marmură	Uscată	★☆☆☆☆
D-52788	230	22,23	7	1	Beton, marmură	Uscată	★☆☆☆☆



Discuri diamantate ondulate pentru beton



Cod	Diametru (mm)	Alezaj (mm)	Înălțime segment (mm)	Ambalare (buc./set)	Material	Tip tăiere	Gamă
B-22034	110	20	5	1	1 2 3 4 5 6	Umedă	★★★★☆



Discuri diamantate ondulate pentru beton



Cod	Diametru (mm)	Alezaj (mm)	Înălțime segment (mm)	Ambalare (buc./set)	Material	Tip tăiere	Gamă
D-41632	125	22,23	7.5	1	Beton	Uscată	★★★☆☆
D-41654	230	22,23	7.5	1	Beton	Uscată	★★★☆☆
A-84171	230	22,23	7.5	1	2 3 4 5	Uscată	★★★☆☆



Discuri diamantate ondulate pentru beton, marmură



Cod	Diametru (mm)	Alezaj (mm)	Înălțime segment (mm)	Ambalare (buc./set)	Material	Tip tăiere	Gamă
D-52794	115	22,23	7	1	Beton, Marmură	Uscată	★☆☆☆☆
D-52803	125	22,23	7	1	Beton, Marmură	Uscată	★☆☆☆☆
D-52825	230	22,23	7	1	Beton, Marmură	Uscată	★☆☆☆☆

Discuri diamantate ondulate pentru beton, marmură

Cod	Diametru (mm)	Alezaj (mm)	Înălțime segment (mm)	Ambalare (buc./set)	Material	Tip tăiere	Gamă
A-80690	125	22,23	7.8	1	beton, plăci ceramice	Uscată	★★★★☆

Discuri diamantate ondulate segmentate pentru beton

Cod	Diametru (mm)	Alezaj (mm)	Înălțime segment (mm)	Ambalare (buc./set)	Material	Tip tăiere	Gamă
A-80438	125	22,23	7.5	1	2 3 4 5	Uscată	★★★★☆

Discuri diamantate ondulate pentru granit

Cod	Diametru (mm)	Alezaj (mm)	Înălțime segment (mm)	Ambalare (buc./set)	Material	Tip tăiere	Gamă
A-84056	115	22,23	7,25	1	1 2 3 4 5	Uscată	★★★★☆
A-84062	125	22,23	7,15	1	1 2 3 4 5	Uscată	★★★★☆

Discuri diamantate continue pentru plăci ceramice porțelanate

Cod	Diametru (mm)	Alezaj (mm)	Înălțime segment (mm)	Ambalare (buc./set)	Material	Tip tăiere	Gamă
D-52716	110	22,23	5	1	plăci ceramice porțelanate	Uscată	★☆☆☆☆



Discuri segmentate cu particule diamante aplicate în vacuum



Cod	Diametru (mm)	Alezaj (mm)	Înălțime segment (mm)	Ambalare (buc./set)	Material	Tip tăiere	Gamă
B-53693	125	22,23	1,8	1	Metal	Uscată	Specializat
B-53718	230	22,23	1,8	1	Metal	Uscată	Specializat



Discuri pentru operatiuni de salvare



Cod	Diametru (mm)	Alezaj (mm)	Înălțime segment (mm)	Ambalare (buc./set)	Material	Tip tăiere	Gamă
B-55310	125	22,23	3	1	multi-material	Uscată	Specializat
B-66949	180	22,23	3	1	multi-material	Uscată	Specializat
B-55326	230	22,23	3	1	multi-material	Uscată	Specializat
B-55332	305	25,4	3	1	multi-material	Uscată	Specializat
B-66955	405	25,4	3	1	multi-material	Uscată	Specializat



Discuri cu particule diamantate electro placate pentru marmură



Cod	Diametru (mm)	Alezaj (mm)	Înălțime segment (mm)	Ambalare (buc./set)	Material	Tip tăiere	Gamă
D-51085	115	22,23	5	1	marmură	Uscată	★★★★☆
D-51100	230	22,23	5	1	marmură	Uscată	★★★★☆



Discuri diamantate continue pentru mașini cu acumulatori



Cod	Diametru (mm)	Alezaj (mm)	Înălțime segment (mm)	Ambalare (buc./set)	Material	Tip tăiere	Gamă
B-21098	80	15	5	1	Sticlă, plăci ceramice	Umedă	★★★★☆



Discuri diamantate segmentate pentru debitor cu acumulatori



Cod	Diametru (mm)	Alezaj (mm)	Înălțime segment (mm)	Ambalare (buc./set)	Material	Tip tăiere	Gamă
E-12996	355	25,4	10	1	Beton	Umedă și uscată	★★★★☆
E-23226	355	25,4	8	1	Beton	Umedă și uscată	★★★★☆



Discuri diamantate segmentate pentru tăiere uscată



Cod	Diametru (mm)	Alezaj (mm)	Înălțime segment (mm)	Grosime tăiere (mm)	Turație maximă (min ⁻¹)	Descriere	Recomandat pentru	Ambalare (buc./set)
D-52750	115	22,23	7	1,8	13.300	Disc segmentat	beton, marmură	1



Discuri diamantate ondulate



Cod	Diametru (mm)	Alezaj (mm)	Înălțime segment (mm)	Grosime tăiere (mm)	Turație maximă (min ⁻¹)	Descriere	Recomandat pentru	Ambalare (buc./set)
B-46333	125	22,23	10	1,4	12.25	disc ondulat	plăci ceramice	1
P-22311	150	22,23	7	2,4	10.18	disc ondulat	beton	1

Seturi discuri diamantate

Cod	Diametru (mm)	Alezaj (mm)	Grosime tăiere (mm)	Înălțime segment (mm)	Turație maximă (min ⁻¹)	Descriere	Recomandat pentru	Ambalare (buc./set)
D-61167-10	125	22,23	2,2	7	12.250	disc ondulat	granit, beton, marmură	10/1
D-61139-10	125	22,23	2,2	7	12.250	disc segmentat	granit, beton, marmură	10/1
D-61173-10	230	22,23	2,2	7	12.250	disc ondulat	granit, beton, marmură	10/1



Discuri diamantate segmentate



Cod	Diametru (mm)	Alezaj (mm)	Ambalare (buc./set)	Material	Tip tăiere	Gamă
D-80086	125	22,23	1	universal	Umedă si uscată	★★★★☆
D-80117	230	22,23	1	universal	Umedă si uscată	★★★★☆
D-80139	350	25.4	1	universal	Umedă si uscată	★★★★☆



Discuri diamantate ondulate



Cod	Diametru (mm)	Alezaj (mm)	Ambalare (buc./set)	Material	Tip tăiere	Gamă
D-80167	125	22,23	1	granit, beton, marmură	Umedă si uscată	★★★★☆
D-80195	230	22,23	1	granit, beton, marmură	Umedă si uscată	★★★★☆



Discuri diamantate continue



Cod	Diametru (mm)	Alezaj (mm)	Ambalare (buc./set)	Material	Tip tăiere	Gamă
D-80226	125	22,23	1	plăci ceramice	Umedă si uscată	★★★★☆
D-80254	230	22,23	1	plăci ceramice	Umedă si uscată	★★★★☆



Discuri diamantate continue pentru plăci ceramice porțenale



Cod	Diametru (mm)	Alezaj (mm)	Înălțime segment (mm)	Ambalare (buc./set)	Material	Tip tăiere	Gamă
D-52738	200	25,4	5	1	Beton	Umedă	★☆☆☆☆

Discuri tăiere DMC300



Cod	Diametru (mm)	Alezaj (mm)	Înălțime segment (mm)	Ambalare (buc./set)	Material	Tip tăiere	Gamă
D-74837	76	10		1	PVC, plastic, rigips	Umedă	★☆☆☆☆
D-77815-5	76	10		5	inox	Uscată	★☆☆☆☆
D-77263	76	10	7	1	plăci ceramice	Uscată	★★★☆☆
D-74790	76	10		1	plăci ceramice	Uscată	★★★☆☆

Discuri tăiere cu carbură de Tungsten

Muchia cu carbură sudată de tungsten permite tăierea cu o viteză mai mare și asigură o durată de viață prelungită. Recomandat pentru tăiere plăci de rigips, PVC, plăci FRP. Nu este recomandat pentru tăierea lemnului, la tăierea lemnului reculul este foarte mare ceea ce poate duce la accidentări.



Cod	Diametru (mm)	Alezaj (mm)	Înălțime segment (mm)	Ambalare (buc./set)	Material	Tip tăiere	Gamă
B-57722	125	22,23	/	1	PVC, Epoxy, rigips	Uscată	Specializat
E-11760	115	X-LOCK	/	1	PVC, epoxy, fibră de sticlă, rigips	Uscată	Specializat
E-11776	125	X-LOCK	/	1	PVC, epoxy, fibră de sticlă, rigips	Uscată	Specializat

Inel de reducere



Cod	Diametru interior (mm)	Diametru exterior (mm)	Ambalare (buc./set)
A-85248	20	22,23	10/1

DISCURI ABRAZIVE DIAMANTATE CU DEGAJARE

CU VIBRAȚII REDUSE

Disponerea segmentelor permite prelucrarea uniformă a suprafeței.



MARGINE SINGULARĂ

- › Nivel ridicat de îndepărtare a deșeurilor



MARGINE DUBLĂ

- › Nivel mediu de îndepărtare a deșeurilor
- › Durată de viață extinsă



MARGINE TIP VENTILATOR

- › Pentru a obține suprafețe curate și netede
- › Polizare grosieră și îndepărtare material



TIP TURBO

- › Polizare fină / finisaje
- › Îndepărtare rapidă a prafului
- › Formatare precisă a colțurilor și marginilor

MAI PUȚINE RESTURI DE MATERIAL



Cu vibrații reduse



Normal

Contactul mai bun cu suprafața de lucru permite o șlefuire mai rapidă, eficientă și uniformă.

Comparație a suprafețelor după 30 de secunde de lucru.

VIBRAȚII REDUSE

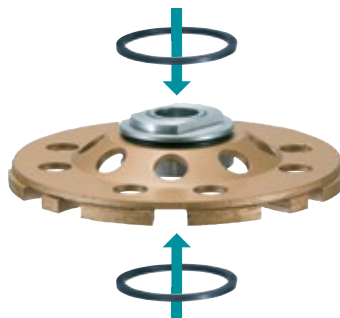

Absoarbe vibrațiile, astfel ușurând considerabil munca.

Cele două garnituri din cauciuc funcționează ca amortizoare și reduc vibrațiile.

DISC ABRAZIV DIAMANTAT CU DEGAJARE PCD

Foarte eficient în curățarea spumei poliuretanică, adezivului, resturilor de vopsea sau izolației.



STANDARD



PCD













Discul normal doar a zgâriat suprafața și nu a putut îndepărta urmele de vopsea.

DISCURI PENTRU ȘLEFUIREA PLĂCILOR DE BETON
Discuri pentru șlefuirea plăcilor de beton

Puteți alege discurile diamantate pentru lucrări grosiere sau o finisare netedă. Discurile sunt recomandate pentru șlefuirea suprafețelor din beton și piatră naturală.







	Cod	Descriere	Diametru (mm)	Alezaj (mm)	Lățime segment (mm)	Înălțime segment (mm)	Recomandat pentru	Compatibil	Turație maximă (min ⁻¹)	Ambalare (buc./set)
	B-12289	Disc cu margine	125	22,23	14,2	4,2	lucrări fine	polizor 115 mm	12.250	1
	B-12295	Disc dublu segmentat	125	22,23	8	5	prelucrare grosieră	PC5000, PC5001C, polizor 125 mm	12.250	1
	B-38560	Disc dublu segmentat	125	M14	/	/	utilizare generală	polizor 115 mm	12.250	1
	D-60682	Disc simplu segmentat	125	22,23	8	5	prelucrare grosieră	PC5000, PC5001C, polizor 125 mm	12.250	1
	D-80569	Disc cu 1 rand de segmente	125	22,23	/	5	prelucrare grosieră	PC5000, PC5001C, polizor 125 mm	12.250	1
	D-80575	Disc cu 1 rand de segmente	180	22,23	/	5	prelucrare grosieră	polizor 180 mm	7.800	1
	D-80606	Disc cu 2 randuri de segmente	125	22,23	/	5	utilizare generală	PC5000, PC5001C, polizor 125 mm	12.250	1
	D-80612	Disc cu 2 randuri de segmente	180	22,23	/	5	utilizare generală	polizor 180 mm	7.800	1

	Cod	Descriere	Diametru (mm)	Alezaj (mm)	Lățime segment (mm)	Înălțime segment (mm)	Recomandat pentru	Compatibil	Turație maximă (min ⁻¹)	Ambalare (buc./set)
	D-80640	Disc cu 3 randuri de segmente	125	22,23	/	5	lucrări fine	PC5000, PC5001C, polizor 125 mm	12.250	1
	D-80656	Disc cu 3 randuri de segmente	180	22,23	/	5	lucrări fine	polizor 180 mm	7.800	1

Inele aspirare praf și perii



	Cod	Descriere	Compatibil cu	Ambalare (buc./set)
	424525-4	Inel protecție Tip A	PC5000C, PC5001C	1
	424526-2	Protecție împotriva prafului Tip B	PC5000C, PC5001C	1
	743340-0	Perie de protecție inel praf tip A	PC5000C, PC5001C	1
	743341-8	Perie de protecție inel praf tip B	PC5000C, PC5001C	1

Plăci pentru șlefuit diamantate



Cod	Descriere	Diametru (mm)	Granulație	Compatibil	Ambalare (buc./set)
443121-9	Perie de protecție împotriva prafului	/	/	PW5000CH	1
743080-0	Pad de suport	100	/	PW5000CH	1
D-15584	Disc diamantat pentru șlefuire piatră, albastru	100	50	PW5000CH	1
D-15590	Disc diamantat pentru șlefuire piatră, galben	100	100	PW5000CH	1
D-15609	Disc diamantat pentru șlefuire piatră, portocaliu	100	200	PW5000CH	1
D-15621	Disc diamantat pentru șlefuire piatră, verde închis	100	800	PW5000CH	1

Cod	Descriere	Diametru (mm)	Granulație	Compatibil	Ambalare (buc./set)
D-15637	Disc diamantat pentru șlefuire piatră, verde deschis	100	1.5	PW5000CH	1
D-15643	Disc diamantat pentru șlefuire piatră, maro	100	3	PW5000CH	1
D-15659	Disc diamantat pentru șlefuire piatră, verde	100	/	PW5000CH	1
D-15805	Set 8 discuri diamantate	100	50-3.000	PW5000CH	8/1

Carote diamantate brazate în vacuum pentru polizoare

Recomandat pentru polizoarele cu prindere M14. Carotele au o muchie cu particule diamantate care sunt brazate în vacuum. Acest proces de îmbinare a materialelor creează o legătură mult mai puternică decât alte metode.



Cod	Diametru (mm)	Prindere	Turație maximă (min ⁻¹)	Ambalare (buc./set)
D-79902	5	M14	12,000	1
D-79918	6	M14	12,000	1
D-79924	8	M14	12,000	1
D-79930	10	M14	12,000	1
D-79946	12	M14	12,000	1
D-44448	16	M14	12.000	1
D-44454	20	M14	12.000	1
D-44460	22	M14	12.000	1
D-44482	27	M14	12.000	1
D-44498	30	M14	12.000	1
D-44529	38	M14	12.000	1
D-44579	57	M14	12.000	1
D-44585	60	M14	12.000	1
D-44600	67	M14	12.000	1
D-44616	68	M14	12.000	1



DISCURI DE TĂIERE ȘI DISCURI ABRAZIVE

DISCURI DE TĂIERE SUBȚIRI pentru polizoare unghiulare cu acumulatori



AVANTAJELE SERIEI PENTRU MAȘINILE CU ACUMULATORI

Eficiența ridicată reduce timpul de lucru.
Mai multe lucrări cu o singură încărcare a acumulatorului.

MATERIALE



NUMĂRUL LUCRĂRILOR

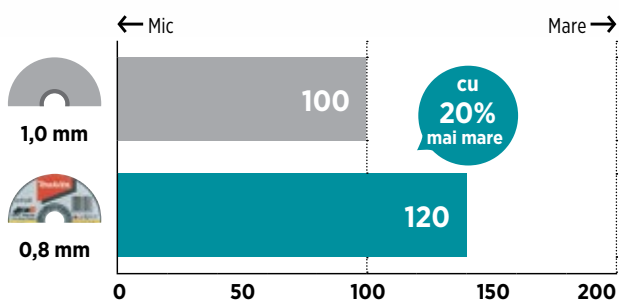

NOTĂ: 1. Rezultatele testelor depind de diverși factori. 2. Valorile din grafic sunt relative când capacitatea discului diamantat Makita (grosime 1,0 mm) este indexată cu 100.

COMPARAȚIE



DISCURI ABRAZIVE

Pentru uz industrial



CARACTERISTICI

Durată de viață extinsă.
Performanță înaltă în uzul industrial.

MATERIALE



DURATA DE VIAȚĂ

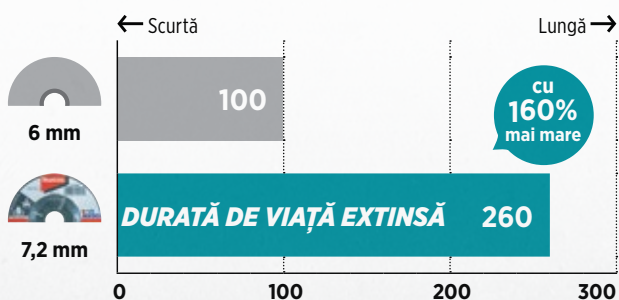

GROSIMEA DISCULUI



DISCURI TĂIERE SUBȚIRI

Discuri plate pentru tăiere metal

Discuri de tăiere presate la rece și lipite cu rășină, capacitate mare de tăiere și durată mai lungă de viață.



Cod	Tip disc	Diametru (mm)	Alezaj (mm)	Grosime disc (mm)	Turație maximă (min ⁻¹)	Ambalare (buc./set)	Gamă
A-85313	A30R	125	22,23	2.5	12.250	1	★★★★☆
A-85335	A30R	230	22,23	2.5	6.650	1	★★★★☆

Discuri plate pentru tăiere metal

Discuri de tăiere presate la rece și lipite cu rășină, capacitate mare de tăiere și durată mai lungă de viață.



Cod	Tip disc	Diametru (mm)	Alezaj (mm)	Grosime disc (mm)	Turație maximă (min ⁻¹)	Ambalare (buc./set)	Gamă
D-18661	A30S	115	22,23	2.5	13.300	1	★★★★☆
D-18677	A30S	125	22,23	2.5	6.650	1	★★★★☆
D-18699	A30S	230	22,23	2.5	6.650	1	★★★★☆

Discuri plate pentru tăiere zidărie



Cod	Tip disc	Diametru (mm)	Alezaj (mm)	Grosime disc (mm)	Turație maximă (min ⁻¹)	Ambalare (buc./set)	Gamă
D-18720	C30S	125	22,23	3	12.250	1	★★★★☆

Discuri plate pentru tăiere oțel inoxidabil

Disc de tăiere subțire și performant, cu duritate medie, sarcină redusă a mașinii, uzură redusă și viteză ridicată, economie de energie, capacitate de tăiere extrem de mare și durată lungă de viață.



Cod	Tip disc	Diametru (mm)	Alezaj (mm)	Grosime disc (mm)	Turație maximă (min ⁻¹)	Ambalare (buc./set)	Gamă
E-03034	A60U	115	22,23	1	13.300	1	★★★★☆
E-03040	A60U	125	22,23	1	12.250	1	★★★★☆
E-13742	A60U	150	22,23	1.6	10.200	1	★★★★☆
E-13758	A60U	180	22,23	1.6	8.500	1	★★★★☆
E-13764	A60U	230	22,23	1.9	6.500	1	★★★★☆

Discuri plate pentru tăiere oțel inoxidabil

Disc de tăiere subțire și performant, cu duritate medie, sarcină redusă a mașinii, uzură redusă și viteză ridicată, economie de energie, capacitate de tăiere extrem de mare și durată lungă de viață.



Cod	Tip disc	Diametru (mm)	Alezaj (mm)	Grosime disc (mm)	Turație maximă (min ⁻¹)	Ambalare (buc./set)	Gamă
D-65953	WA46R	115	22,23	1	13.300	1	★★★★☆
D-65969	WA46R	125	22,23	1	12.250	1	★★★★☆
D-65975	WA46R	180	22,23	2	8.500	1	★★★★☆
D-18764	WA60T	115	22,23	1.2	13.300	1	★★★★☆
D-18792	WA36R	230	22,23	2	8.500	1	★★★★☆

Discuri plate pentru tăiere oțel inoxidabil

Disc de tăiere subțire și performant, cu duritate medie, sarcină redusă a mașinii, uzură redusă și viteză ridicată, economie de energie, capacitate de tăiere extrem de mare și durată lungă de viață.



Cod	Tip disc	Diametru (mm)	Alezaj (mm)	Grosime disc (mm)	Turație maximă (min ⁻¹)	Ambalare (buc./set)	Gamă
D-75524	WA46R	115	22,23	1	13.300	1	★☆☆☆☆
D-75530	WA46R	125	22,23	1	12.250	1	★☆☆☆☆
D-75546	WA46R	150	22,23	2	10.200	2	★☆☆☆☆
D-75552	WA46R	180	22,23	2	8.500	3	★☆☆☆☆
D-75568	WA46R	230	22,23	2	6.650	4	★☆☆☆☆

Discuri plate pentru tăiere oțel inoxidabil X-LOCK

Sistemul permite montarea și demontarea fără alte instrumente. Sunt compatibile pentru toate polizoarele X-LOCK și toate polizoarele cu piuliță de montare.



Cod	Tip disc	Diametru (mm)	Alezaj (mm)	Grosime disc (mm)	Turație maximă (min ⁻¹)	Ambalare (buc./set)	Gamă
E-00418	A60T	125	X-LOCK	1.2	12.250	1	★★★★☆

Discuri plate pentru tăiere aluminiu



Cod	Tip disc	Diametru (mm)	Alezaj (mm)	Grosime disc (mm)	Turație maximă (min ⁻¹)	Ambalare (buc./set)	Gamă
B-45331	A60T	125	22,23	1	12.250	1	★★★★☆

Discuri plate pentru tăiere oțel inoxidabil



Cod	Tip disc	Diametru (mm)	Alezaj (mm)	Grosime disc (mm)	Turație maximă (min ⁻¹)	Ambalare (buc./set)	Gamă
E-22947	Z60U	115	22,23	0.8	13.300	1	★★★★☆
E-10877	Z60U	125	22,23	0.8	12.250	1	★★★★☆
E-22953	Z60V	125	22,23	0.8	12.250	1	★★★★☆

Discuri pentru debitatoare portabile pentru tăiere metal



Cod	Tip disc	Diametru (mm)	Alezaj (mm)	Grosime disc (mm)	Turație maximă (min ⁻¹)	Ambalare (buc./set)	Gamă
B-10665-5	A36P	355	25,4	3	4800	5	★★★★☆
B-64696-5	A36P	355	25,4	2.5	4800	5	★★★★☆
B-49448-5	A36P	355	25,4	2.5	4800	5	★★★★☆

Discuri pentru debitoare portabile pentru tăiere aluminiu

Cod	Tip disc	Diametru (mm)	Alezaj (mm)	Grosime disc (mm)	Turație maximă (min ⁻¹)	Ambalare (buc./set)	Gamă
E-04961-5	AC30P	355	25,4	3	4800	5	★★★★☆
E-04977-5	AC30P	355	25,4	2.8	4800	5	★★★★☆

Discuri pentru debitoare portabile cu acumulatori pentru tăiere metal

Cod	Tip disc	Diametru (mm)	Alezaj (mm)	Grosime disc (mm)	Turație maximă (min ⁻¹)	Ambalare (buc./set)	Gamă
E-12790-5	A24T	355	25,4	4.3	4800	5	★★★★☆

DISCURI PENTRU POLIZARE
Discuri de polizat pentru polizoare de banc

Cod	Tip disc	Diametru (mm)	Alezaj (mm)	Grosime disc (mm)	Turație maximă (min ⁻¹)	Ambalare (buc./set)	Gamă
B-51895	A60M	150	12.7	6.4	-	1	★★★★☆
B-51904	A36M	150	12.7	16		1	★★★★☆
B-51910	A60M	150	12.7	16		1	★★★★☆
B-51948	A36P	205	15.88	19		1	★★★★☆
B-51926	WA60K	150	12.7	16		1	★★★★☆
B-51960	WA60K	205	15.88	19		1	★★★★☆
B-51932	GC120H	150	12.7	16		1	★★★★☆
B-51976	GC120H	205	15.88	19		1	★★★★☆

Pietre de ascuțit pentru metal



Cod	Granulație	Dimensiuni (mm)	Ambalare (buc./set)	Gamă
794060-9	A1200	180x70	1	★★★★☆

Discuri cu centru deplasat pentru polizare metal

Discurile de polizare Makita pentru metal sunt discuri abrazive universale de duritate medie, potrivite pentru toate tipurile și metodele de prelucrare a metalelor. Tipuri de aplicații: curățarea sudurilor, curățarea pieselor turnate, polizarea muchiilor și suprafețelor plane. Discurile sunt presate la rece și lipite cu rășină.



Cod	Tip disc	Diametru (mm)	Alezaj (mm)	Grosime disc (mm)	Turație maximă (min ⁻¹)	Ambalare (buc./set)	Gamă
A-80927	A36P	115	22,23	6	13.300	1	★★★★☆
A-80933	A36P	125	22,23	6	12.250	1	★★★★☆
A-80955	A36P	230	22,23	6	6.650	1	★★★★☆

Discuri cu centru deplasat pentru polizare metal



Cod	Tip disc	Diametru (mm)	Alezaj (mm)	Grosime disc (mm)	Turație maximă (min ⁻¹)	Ambalare (buc./set)	Gamă
D-18459	A24R	115	22,23	6	13.300	1	★★★★☆
D-18465	A24R	125	22,23	6	12.250	1	★★★★☆
D-18487	A24R	230	22,23	6	6.600	1	★★★★☆

Discuri cu centru deplasat pentru polizare metal



Cod	Tip disc	Diametru (mm)	Alezaj (mm)	Grosime disc (mm)	Turație maximă (min ⁻¹)	Ambalare (buc./set)	Gamă
D-74485	A24P	115	22,23	6	13.300	1	★☆☆☆☆
D-74491	A24P	125	22,23	6	12.250	1	★☆☆☆☆
D-74522	A24P	230	22,23	6	12.250	1	★☆☆☆☆

Discuri cu centru deplasat pentru polizare oțel inoxidabil



Cod	Tip disc	Diametru (mm)	Alezaj (mm)	Grosime disc (mm)	Turație maximă (min ⁻¹)	Ambalare (buc./set)	Gamă
A-80640	WA36N	115	22,23	6	13.300	1	★★★★☆
A-80656	WA36N	125	22,23	6	12.250	1	★★★★☆
A-80896	WA36O	230	22,23	6	6.650	1	★★★★☆

Discuri polizare pentru oțel inoxidabil - uz industrial



1. Grosime de 7,2 mm pentru a fi folosit în industria grea.
Este ideal pentru utilizare cu polizoare de mare putere.

2. Durată de viață extinsă

Durată de viață - polizare (minute)

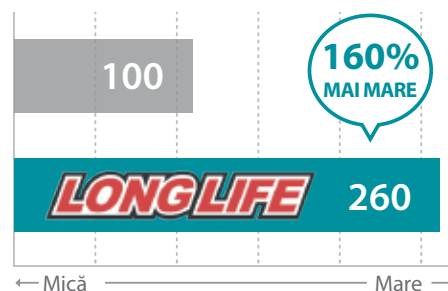
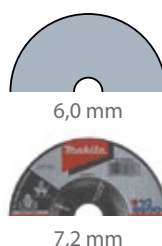
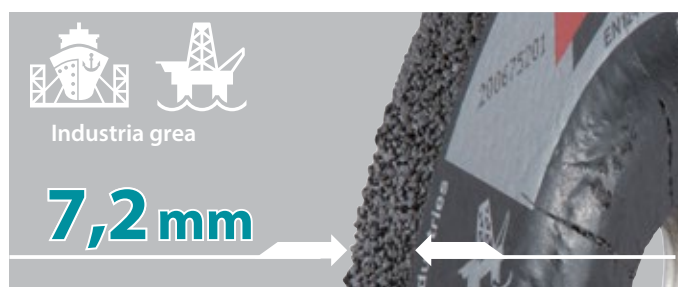

Cod	Tip disc	Diametru (mm)	Alezaj (mm)	Grosime disc (mm)	Turație maximă (min ⁻¹)	Ambalare (buc./set)	Gamă
B-66927	22,23	125	7.2	Ceramic A24P	13.300	1	★★★★★

Discuri cu centru deplasat pentru polizare oțel inoxidabil X-LOCK



Cod	Tip disc	Diametru (mm)	Alezaj (mm)	Grosime disc (mm)	Turație maximă (min ⁻¹)	Ambalare (buc./set)	Gamă
E-00402	WA36N	125	X-LOCK	6	12.250	1	★★★★☆

DISCURI LAMELARE



DISCURI ABRAZIVE LAMELARE PENTRU UZ INDUSTRIAL



Eficiență ridicată
Durată de viață extinsă

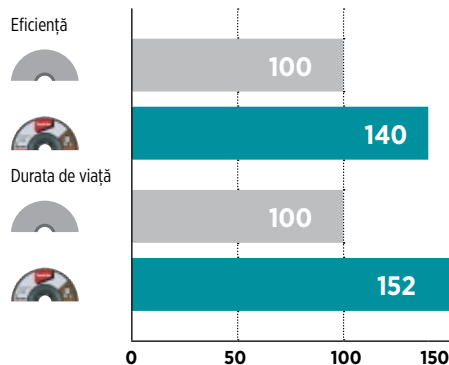

TIP DE SUPORT



Suport de fibră de sticlă
Standard



Suport nailon
Aplicații dure

FORMĂ



Dreaptă
Pentru suprafețe plane



Înclinată
Pentru suprafețe curbate

DIAGRAMA MATERIALELOR

Material abraziv	A	Z	C	Ce
	Oxid de aluminiu	Aluminiu zirconiu	Carbură de siliciu	Oxid ceramic de aluminiu
Cod culoare	Albastru: metal	Auriu: inox și metal	Verde: zidărie	Argintiu: inox, metal și neferoase
Lemn	★			
Plastic	★			
Metal	★★	★★		★★
Metale neferoase	★	★		★★
Inox		★★		★★
Zidărie			★★	

★★: Recomandat ★: Adecvat

DISCURI ABRAZIVE LAMELARE
Discuri abrazive lamelare înclinate cu granule oxid de aluminiu pentru metal, metale neferoase, PVC

Potrivit pentru diverse materiale: metale feroase, neferoase, plastic, lemn. Discurile lamelare cu oxid de aluminiu sunt potrivite pentru polizarea plăcilor subțiri de oțel și sunt proiectate pentru polizare grosieră precum și pentru polizare fină și finisare. Foile abrazive sunt poziționate în evantai și sunt montate pe o placă din fibră de sticlă de calitate. Cele mai importante proprietăți sunt: grad ridicat și constant de polizare la temperatură joasă, calitatea suprafeței prelucrate, durată de viață prelungită și zgomot redus. Aplicații: îndepărtarea ruginii, curățarea pieselor turnate, finisare.



Cod	Diametru (mm)	Alezaj (mm)	Granulație	Turație maximă (min ⁻¹)	Ambalare (buc./set)	Gamă
D-63432	115	22,23	A40	13300	1	★☆☆☆☆
D-63448	115	22,23	A60	13300	1	★☆☆☆☆
D-63454	115	22,23	A80	13300	1	★☆☆☆☆
D-63476	125	22,23	A40	12250	1	★☆☆☆☆
D-63482	125	22,23	A60	12250	1	★☆☆☆☆
D-63498	125	22,23	A80	12250	1	★☆☆☆☆
D-63507	125	22,23	A120	12250	1	★☆☆☆☆
D-63513	180	22,23	A40	8500	1	★☆☆☆☆
D-63529	180	22,23	A60	8500	1	★☆☆☆☆
D-63535	180	22,23	A80	8500	1	★☆☆☆☆
D-63541	180	22,23	A120	8500	1	★☆☆☆☆

Discuri abrazive lamelare înclinate cu granule de zirconiu aluminiu pentru metal, oțel inoxidabil, metale neferoase

Cod	Diametru (mm)	Alezaj (mm)	Granulație	Turație maximă (min ⁻¹)	Ambalare (buc./set)	Gamă
D-27492	125	22,23	Z60	12250	1	★★★☆☆
D-27517	125	22,23	Z120	12250	1	★★★☆☆

Discuri abrazive lamelare înclinate cu granule de zirconiu aluminiu pentru metal, oțel inoxidabil, metale neferoase

Cod	Diametru (mm)	Alezaj (mm)	Granulație	Turație maximă (min ⁻¹)	Ambalare (buc./set)	Gamă
D-63769	115	22,23	Z80	13300	1	★☆☆☆☆
D-63781	125	22,23	Z40	12250	1	★☆☆☆☆

Cod	Diametru (mm)	Alezaj (mm)	Granulație	Turație maximă (min ⁻¹)	Ambalare (buc./set)	Gamă
D-63797	125	22,23	Z60	12.250	1	★☆☆☆☆
D-63806	125	22,23	Z80	12.250	1	★☆☆☆☆
D-63812	125	22,23	Z120	12.250	1	★☆☆☆☆
D-63828	180	22,23	Z40	8.500	1	★☆☆☆☆

Discuri abrazive lamelare pentru oțel inoxidabil - zirconiu

Aceste discuri sunt recomandate pentru polizarea oțelului inoxidabil și a metalului. Sunt cele mai populare discuri lamelare. Discurile lamelare sunt recomandate pentru polizarea unor straturi groase la presiune sau temperatură scăzută. Discurile lamelare pentru inox cu zirconiu sunt potrivite pentru cele mai solicitante aplicații - pentru polizare grosieră și finisare. Foile abrazive sunt așezate în formă de evantai și sunt montate pe o placă de fibră de sticlă de calitate. Cele mai importante proprietăți ale discurilor lamelare sunt: grad ridicat de polizare la temperatură scăzută, calitate ridicată, suprafețe tratate, durată de viață prelungită, nivel de zgomot scăzut. Aplicații: îndepărtarea ruginii, curățarea turnării, șlefuirea marginilor, finisare.



Cod	Diametru (mm)	Alezaj (mm)	Granulație	Turație maximă (min ⁻¹)	Ambalare (buc./set)
P-65464	115	22,23	Z60	13.300	1
P-65470	115	22,23	Z80	13.300	1
P-65589	180	22,23	K60	13.300	1
P-65501	125	22,23	Z60	12.250	1
P-65517	125	22,23	Z80	12.250	1
P-65523	125	22,23	Z120	12.250	1

Discuri lamelare pentru metal - oxid aluminiu

Potrivit pentru diverse materiale: metale feroase, neferoase, plastic, lemn. Discurile lamelare cu oxid de aluminiu sunt potrivite pentru polizarea plăcilor subțiri de oțel și sunt proiectate pentru polizare grosieră precum și pentru polizare fină și finisare. Foile abrazive sunt poziționate în evantai și sunt montate pe o placă din fibră de sticlă de calitate. Cele mai importante proprietăți sunt: grad ridicat și constant de polizare la temperatură joasă, calitatea suprafeței prelucrate, durată de viață prelungită și zgomot redus. Aplicații: îndepărtarea ruginii, curățarea pieselor turnate, finisare.



Cod	Diametru (mm)	Alezaj (mm)	Granulație	Turație maximă (min ⁻¹)	Ambalare (buc./set)
P-65137	115	22,23	A40	13.300	1
P-65143	115	22,23	A60	13.300	1
P-65159	115	22,23	A80	13.300	1
P-65165	115	22,23	A120	13.300	1
P-65187	125	22,23	A60	12.000	1
P-65193	125	22,23	A80	12.000	1
P-65202	125	22,23	A120	12.000	1
P-65252	180	22,23	A40	8.600	1
P-65268	180	22,23	A60	8.600	1
P-65274	180	22,23	A80	8.600	1
P-65280	180	22,23	A120	8.600	1







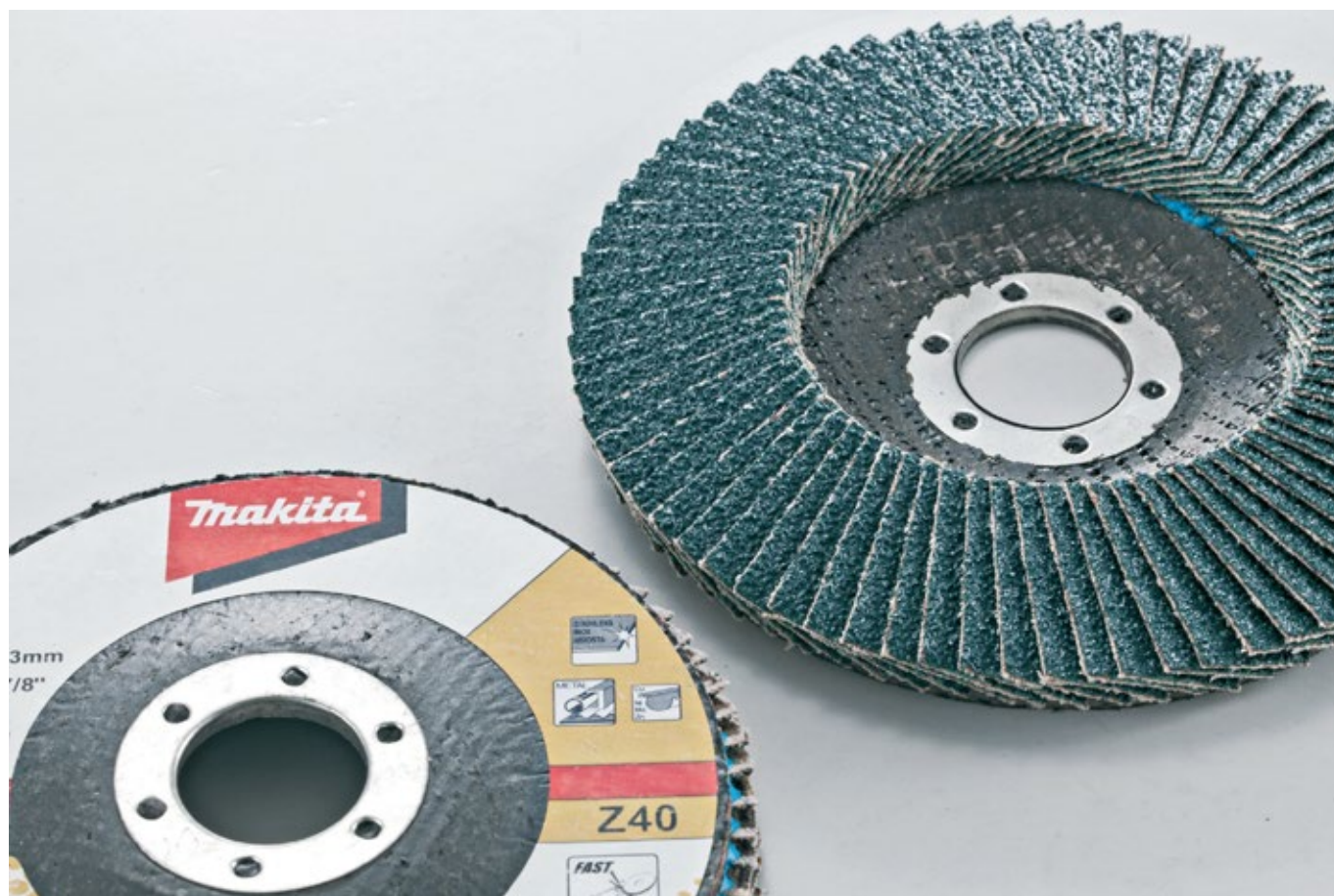

Discuri lamelare pentru zidarie piatra















Cod	Diametru (mm)	Alezaj (mm)	Granulație	Turație maximă (min ⁻¹)	Ambalare (buc./set)
P-65311	115	22,23	80		1
P-65327	115	22,23	120		1
P-65414	180	22,23	40		1
P-65420	180	22,23	60		1
P-65436	180	22,23	80		1
P-65442	180	22,23	120		1

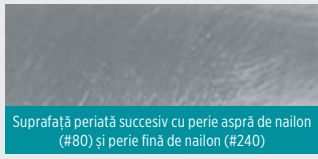

PERII DE SĂRMĂ PENTRU POLIZOARE UNGHIULARE

TIP PERIE	 Perie tip cupă din sârmă ondulată Ideală pentru îndepărtarea ruginii.	 Perie înclinată cu fire răsucite Ideală pentru lucrări dificile.	 Perie tip cupă din sârmă ondulată cu toroane Ideală pentru lucrări dificile.
ASPECT FINAL (SUPRAFAȚĂ METALICĂ)	  < Fină > < Aspră >		
FORMĂ PERIE	 Perie tip cupă din sârmă ondulată cu toroane Pentru suprafețe plane și canelate.	 Perie de sârmă tip rozetă Ideală pentru suprafețe mai mici.	 Perie înclinată cu fire răsucite Ideală pentru muchii și colțuri.

PERII DE SĂRMĂ ȘI NAILON PENTRU MAȘINĂ DE GĂURIT

TIP PERIE	 Perie din sârmă ondulată (0,3 mm) Ideală pentru îndepărtarea ruginii și a vopselei de pe metale.	 Perie aspră de nailon (#80) Ideală pentru finisarea lemnului și îndepărtarea ruginii și a vopselei de pe metale, lemn și plastic.	 Perie fină de nailon (#240) Ideală pentru finisarea suprafețelor din lemn și PVC.	
LEMN		★★	★★	
PLASTIC		★★	★★	
METAL		★★	★★	
ASPECT FINAL (SUPRAFAȚĂ METALICĂ)			 Suprafață periată succesiv cu perie aspră de nailon (#80) și perie fină de nailon (#240)	
FORMĂ PERIE	 Cupă Pentru suprafețe plane sau rugoase.	 Rozetă Potrivită pentru locuri înguste.	 Cupă îngustă Potrivită pentru spații strâmte și adânci.	 Perie circulară Pentru finisarea lemnului.

★★: Recomandat ★: Adecvat

PERII DE SĂRMĂ PENTRU POLIZOARE UNGHIULARE

Perii tip cupă din sârmă ondulată cu toroane

Perii de sârmă din oțel împletit 0,5 mm (ideale pentru pregătirea unor suprafețe de mari dimensiuni). D-29290, D-24153 au fir dublu împletit (excelente pentru aplicații solicitante, mult mai rezistente decât periiile împletite sau alte perii).



Cod	Diametru (mm)	Număr de perii	Diametru fir (mm)	Turație maximă (min ⁻¹)	Prindere	Compatibil cu	Ambalare (buc./set)
D-24119	60	16	0,5	12.500	M14	polizoare unghiulare 125, 150 mm	1
D-24153	60	18	0,5	12.500	M14	polizoare unghiulare 125, 150 mm	1
D-24131	75	18	0,5	12.500	M14	polizoare unghiulare 125, 150 mm	1
D-29290	100	26	0,5	8.500	M14	polizoare unghiulare 180, 230 mm	1
P-04472	100	26	0,5	8.500	M14	polizoare unghiulare 180, 230 mm	1

Perii tip cupă din sârmă ondulată

Perii de sârmă ondulată din oțel de 0,3 mm (excelente pentru îndepărtarea ruginii de pe suprafețe plane și margini).



Cod	Diametru (mm)	Diametru fir (mm)	Turație maximă (min ⁻¹)	Prindere	Compatibil cu	Ambalare (buc./set)
D-24072	60	0,3	12.500	M14	polizoare unghiulare 125, 150 mm	1
D-24094	75	0,3	12.500	M14	polizoare unghiulare 125, 150 mm	1
D-29284	100	0,3	8.500	M14	polizoare unghiulare 180, 230 mm	1
D-78564	100	0,3	12.500	M14	polizoare unghiulare 180, 230 mm	1
D-78570	100	0,3	12.500	M14	polizoare unghiulare 180, 230 mm	1

Perii de sârmă tip rozetă

Perii de sârmă împletită din oțel de 0,5 mm (eficiente pentru curățarea mai exigentă a zonelor de dimensiuni mai mici).



Cod	Diametru (mm)	Număr de perii	Diametru fir (mm)	Turație maximă (min ⁻¹)	Prindere	Compatibil cu	Ambalare (buc./set)
D-29555	100	18	0,5	8.500	M14	polizoare unghiulare 125, 150, 180, 230 mm	1
D-29561	115	20	0,5	8.500	M14	polizoare unghiulare 125, 150, 180, 230 mm	1
D-29577	125	22	0,5	8.500	M14	polizoare unghiulare 125, 150, 180, 230 mm	1

Perii conice de sârmă - fir oțel împletit

Perii conice de sârmă cu fir de oțel împletit de 0,5 mm (eficiente pentru curățarea marginilor și colțurilor).



Cod	Diametru (mm)	Număr de perii	Diametru fir (mm)	Turație maximă (min ⁻¹)	Prindere	Compatibil cu	Ambalare (buc./set)
P-04494	100	18	0,5	12.500	M14	polizoare unghiulare 125, 150, 180, 230 mm	1

Perii conice de sârmă - oțel ondulat

Perii conice de sârmă din oțel de 0,3 mm (potrivite în special pentru curățarea suprafețelor laterale).



Cod	Diametru (mm)	Diametru fir (mm)	Turație maximă (min ⁻¹)	Prindere	Compatibil cu	Ambalare (buc./set)
D-39827	100	0,3	12.500	M14	polizoare unghiulare 125, 150, 180, 230 mm	1

Perii tip cupă de sârmă ondulată alămită

Perii de sârmă din oțel ondulat de 0,3 mm (excelente pentru îndepărtarea ruginii, firul este protejat împotriva coroziunii).



Cod	Diametru (mm)	Diametru fir (mm)	Turație maximă (min ⁻¹)	Prindere	Compatibil cu	Ambalare (buc./set)
D-39746	60	0,3	12.500	M14	polizoare unghiulare 125, 150 mm	1
D-39768	75	0,3	12.500	M14	polizoare unghiulare 125, 150 mm	1
D-39780	90	0,3	8.500	M14	polizoare unghiulare 125, 150 mm	1
D-39805	100	0,3	8.500	M14	polizoare unghiulare 125, 150 mm	1

Perii tip cupă X-LOCK



Cod	Diametru (mm)	Diametru fir (mm)	Turație maximă (min ⁻¹)	Prindere	Ambalare (buc./set)
D-73396	75	0,3	12.500	X-LOCK	1
D-73433	75	0,3	12.500	X-LOCK	1
D-73346	75	0,3	12.500	X-LOCK	1
D-73374	80	0,35	12.500	X-LOCK	1
D-73380	80	0,5	12.500	X-LOCK	1
D-73330	80	0,5	12.500	X-LOCK	1



Perii tip roată X-LOCK



Cod	Diametru (mm)	Diametru fir (mm)	Turație maximă (min ⁻¹)	Prindere	Ambalare (buc./set)
D-73352	115	0,5	12.500	X-LOCK	1
D-73405	115	0,5	12.500	X-LOCK	1
D-73411	115	0,5	12.500	X-LOCK	1
D-73427	115	0,3	12.500	X-LOCK	1
D-73368	115	0,5	12.500	X-LOCK	1
D-73449	100	0,3	/	X-LOCK	1

PERII DE SÂRMĂ PENTRU MAȘINI DE ÎNȘURUBAT

Perii tip rozetă de sârmă ondulată

Potrivite pentru îndepărtarea ruginii, lacurilor și vopselurilor din zonele greu accesibile.



Cod	Diametru (mm)	Diametru fir (mm)	Turație maximă (min ⁻¹)	Prindere	Ambalare (buc./set)
D-39986	75	0,3	4.500	6 mm	1
D-39992	100	0,3	4.500	6 mm	1

Perii tip rozetă de sârmă ondulată alămită



Cod	Diametru (mm)	Diametru fir (mm)	Turație maximă (min ⁻¹)	Prindere	Ambalare (buc./set)
D-73651	38	0,3	4.500	1/4"	1
D-73673	63	0,3	4.500	1/4"	1
D-73695	100	0,3	4.500	1/4"	1

Set perii





Cod	Diametru (mm)	Diametru fir (mm)	Turație maximă (min ⁻¹)	Prindere	Ambalare (buc./set)
D-66070	50, 50, 25	0,3	4.500	6 mm	1

PERII DE NAILON PENTRU MAȘINI DE ÎNȘURUBAT

Perii tip cupă de nailon

Sunt ideale pentru îndepărtarea lacurilor și vopselurilor de pe metal, lemn și plastic.





	Cod	Diametru (mm)	Turație maximă (min ⁻¹)	Granulație	Prindere	Tip finisare	Ambalare (buc./set)
	D-45509	50	4.500	80	6	grosieră	1
	D-45537	50	4.500	240	6	fină	1

Perii tip rozetă din nailon

Ideale pentru îndepărtarea ruginii, lacurilor și vopselurilor de pe metal, lemn și plastic.







	Cod	Diametru (mm)	Turație maximă (min ⁻¹)	Granulație	Prindere	Tip finisare	Ambalare (buc./set)
	D-45565	38	4.500	80	6	grosieră	1
	D-45618	38	4.500	240	6	fină	1

Perii tip pensulă din nailon

Ideale pentru îndepărtarea ruginii, lacurilor și vopselurilor de pe metal, lemn și plastic.









	Cod	Diametru (mm)	Turație maximă (min ⁻¹)	Granulație	Prindere	Tip finisare	Ambalare (buc./set)
	D-45668	12	4.500	80	6	grosieră	1

	Cod	Diametru (mm)	Turație maximă (min ⁻¹)	Granulație	Prindere	Tip finisare	Ambalare (buc./set)
	D-45705	12	4.500	240	6	fină	1
	D-45727	25	4.500	240	6	fină	1
	D-45733	30	4.500	240	6	fină	1

ALTE ACCESORII PENTRU POLIZOARE







Flanșe

	Cod	Descriere	Pentru modelul	Ambalare (buc./set)
	192227-7	Superflanșă polizor	Ø 115-230 mm	1
	195354-9	Piuliță cu eliberare rapidă EZYNUT	Ø 180/230 mm	1
	196297-8	Piuliță de blocare specială	Ø 115/230 mm	1
	224490-5	Flanșă interioară	Ø 115-230 mm	1
	224543-0	Piuliță de blocare	Ø 180/230 mm	1
	224554-5	Piuliță de blocare	Ø 115/125/150 mm	1

Apărătoare colectare praf







	Cod	Descriere	Pentru modelul	Potrivit pentru	Ambalare (buc./set)
	193794-5	Apărătoare colectare praf	/	Polizor unghiular 115/125 mm	1
	196845-3	Apărătoare colectare praf	/	Polizor unghiular 115/125 mm	1
	743332-9	Perie lungă pentru apărătoare 195239-9	/	Polizor unghiular 115/125 mm	1
	743333-7	Perie scurtă pentru apărătoare 195239-9	/	Polizor unghiular 115/125 mm	1
	743334-5	Perie lungă pentru 195385-8	/	Polizor unghiular 180/230 mm	1
	743335-3	Perie scurtă pentru 195385-8	/	Polizor unghiular 180/230 mm	1
	194044-1	Apărătoare colectare praf	/	Polizor unghiular 180/230mm	1
	195385-8	Apărătoare colectare praf	/	Polizor unghiular 180/230mm	1
	198440-5	Apărătoare colectare praf 230 mm	/	Polizor unghiular 180/230mm	1
	193903-6	Set protecții praf	9564H, 9565H, 9565CR,	/	1
	457620-5	Protecție praf	DGA900/DGA700	/	1
	198719-4	Set protecții praf	GA4540C, GA4540R,	/	1
	162708-5	Apărătoare X-Lock 125 mm	GA519D	Polizor unghiular 125 mm	1





	Cod	Descriere	Pentru modelul	Potrivit pentru	Ambalare (buc./set)
	199514-5	Protecție praf	/	/	1
	347479-7	Aparatoare de protecție 115 mm	/	Polizor unghiular 115 mm	1
	347480-2	Aparatoare de protecție 125 mm	/	Polizor unghiular 125 mm	1
	123098-1	Aparatoare de protecție 115 mm	/	Polizor unghiular 115 mm	1
	123099-9	Apărătoare de protecție 125 mm	/	Polizor unghiular 125 mm	1
	123230-7	Apărătoare de protecție 150 mm	GA6010	Polizor unghiular 150 mm	1
	122889-7	Apărătoare de protecție 180 mm	/	Polizor unghiular 180 mm	1
	122891-0	Apărătoare de protecție 230 mm	/	Polizor unghiular 230 mm	1
	195384-0	Apărătoare colectare praf	/	Polizor unghiular 180 mm	1
	194303-3	Apărătoare colectare praf	/	Polizor unghiular 180 mm	1
	162557-0	Apărătoare XGT	/	Polizor unghiular 125 mm	1
	191G05-4	Apărătoare X-Lock cu colectare	/	Polizor unghiular X-Lock 125 mm	1

	Cod	Descriere	Pentru modelul	Potrivit pentru	Ambalare (buc./set)
	199710-5	Apărătoare tăiere	/	Polizor unghiular 125 mm	1
	191W06-8	Apărătoare colectare praf 115/125 mm	GA005, GA008, GA013, GA016, GA023, GA026, GA029, GA032, GA5051	/	1
	194289-1	Set protecție praf	GA7030S, GA7040S,	/	1
	122913-6	Apărătoare de protecție 230 mm	RFK, GA9030/R/RF,	/	1
	122683-7	Talpă reglabilă	4112HS	/	1
	122732-0	Apărătoare colectare praf	LF1000	/	1

ACCESORII PENTRU PERFORARE

















Cuțite perforatoare și accesorii

	Cod	Descriere	Pentru modelul	Ambalare (buc./set)
	191383-0	Set cuțite pentru mașină debitat tablă	JS1600, JS1602	2/1
	762013-6	Șubler	JS1660, JS1601, DJS161	1
	792287-5	Cuțit foarfece cu patru fețe pentru foi de tablă	JS3200, JS3201	2/1
	792292-2	Matriță	JN3200	1
	792533-6	Cuțit lateral	DJS160, DJS161, JS1660, JS1601	2/1
	792534-4	Cuțit tăiere lateral	JS1660, JS1601, DJS161	1

	Cod	Descriere	Pentru modelul	Ambalare (buc./set)
	792536-0	Cuțit lateral	DJS100, DJS101, JS1670, BJS101RFE, JS1000	2/1
	792537-8	Cuțit tăiere lateral	JS1670, BJS101RFE, JS1000	1
	792728-1	Perforator	JS3200, JS3201	1
	A-15051	Matriță	JN1601, DJN161	1
	A-83951	Perforator	JN1601, DJN161	1



ACCESORII PENTRU ȘLEFUIRE

Piatră naturală	
Beton	
Zidărie	
Metal	
Aluminiu	
Oțel inoxidabil	
Metale neferoase	
Sticlă	
Plastic	
Lemn cu cuie	
Lemn	
Lemn moale	
Curățare vopsea de pe metal	
Curățare vopsea	
Suprafețe vopsite sau lăcuite	
Prindere tip scai	
Oxid de aluminiu	

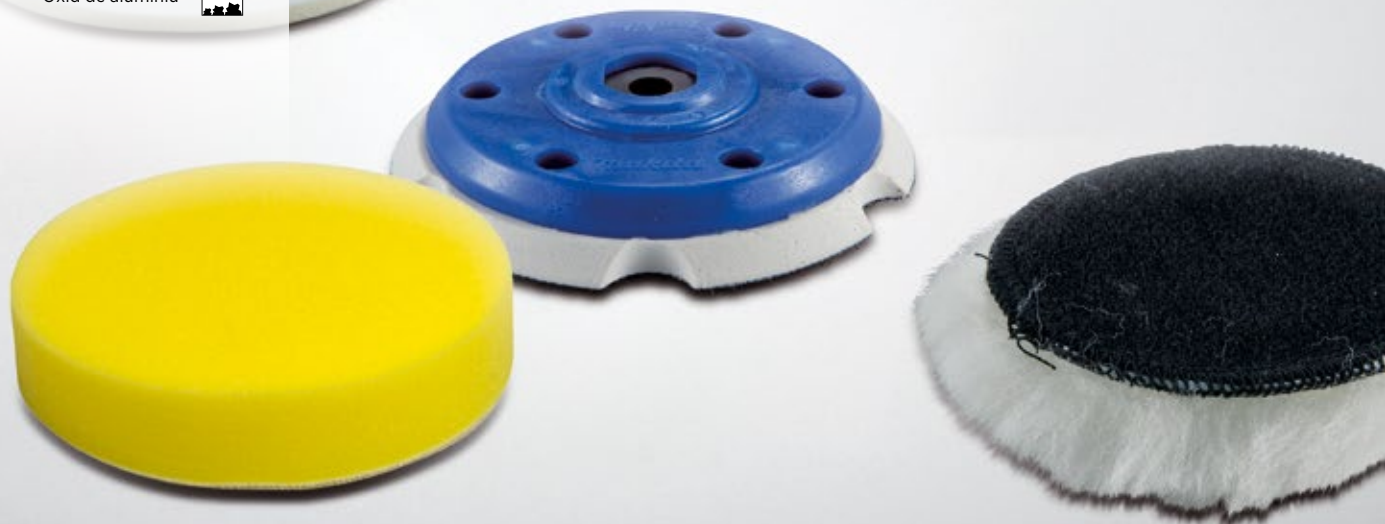

BENZI ABRATIVE
Benzi abrazive 76x457 mm

Cod	Lățime (mm)	Lungime totală (mm)	Granulație	Pentru modelul	Ambalare (buc./set)
P-37091	76	457	40	9910, 9911	5/1
P-37100	76	457	60	9910, 9911	5/1
P-37116	76	457	80	9910, 9911	5/1
P-37122	76	457	100	9910, 9911	5/1
P-37138	76	457	120	9910, 9911	5/1
P-37144	76	457	150	9910, 9911	5/1
P-37150	76	457	240	9910, 9911	5/1
P-37166	76	457	60/80/120	9910, 9911	3/1

Benzi abrazive 76x533 mm

Cod	Lățime (mm)	Lungime totală (mm)	Granulație	Pentru modelul	Ambalare (buc./set)
P-37172	76	533	40	9903	5/1
P-37188	76	533	60	9903	5/1
P-37194	76	533	80	9903	5/1
P-37203	76	533	100	9903	5/1
P-37219	76	533	120	9903	5/1
P-37225	76	533	150	9903	5/1
P-37231	76	533	240	9903	5/1
P-37275	76	533	100	9903	25/1

Benzi abrazive 76x610 mm

Cod	Lățime (mm)	Lungime totală (mm)	Granulație	Pentru modelul	Ambalare (buc./set)
P-37312	76	610	40	9920, 9924DB	5/1
P-37328	76	610	60	9920, 9924DB	5/1
P-37334	76	610	80	9920, 9924DB	5/1

Cod	Lățime (mm)	Lungime totală (mm)	Granulație	Pentru modelul	Ambalare (buc./set)
P-37340	76	610	100	9920, 9924DB	5/1
P-37356	76	610	120	9920, 9924DB	5/1
P-51164	76	610	80	9920, 9924DB	25/1
P-51172	76	610	100	9920, 9924DB	25/1
P-51194	76	610	150	9920, 9924DB	25/1

Benzi abrazive 100x610 mm



Cod	Lățime (mm)	Lungime totală (mm)	Granulație	Pentru modelul	Ambalare (buc./set)
P-36887	100	610	40	9924DB, 9402, 9403, 904	5/1
P-36893	100	610	60	9924DB, 9402, 9403, 904	5/1
P-36902	100	610	80	9924DB, 9402, 9403, 904	5/1
P-36918	100	610	100	9924DB, 9402, 9403, 904	5/1
P-36924	100	610	120	9924DB, 9402, 9403, 904	5/1
P-36930	100	610	150	9924DB, 9402, 9403, 904	5/1
P-36946	100	610	240	9924DB, 9402, 9403, 904	5/1
P-36980	100	610	100	9924DB, 9402, 9403, 904	25/1
P-36996	100	610	120	9924DB, 9402, 9403, 904	25/1
P-37041	100	620	80	9924DB	5/1

Benzi abrazive 6x533 mm



Cod	Lățime (mm)	Lungime totală (mm)	Granulație	Pentru modelul	Ambalare (buc./set)
P-43181	6	533	40	9032	5/1
P-43197	6	533	60	9032	5/1
P-43206	6	533	80	9032	5/1
P-43212	6	533	100	9032	5/1
P-43228	6	533	120	9032	5/1
P-43234	6	533	150	9032	5/1
P-43240	6	533	240	9032	5/1

Benzi abrazive

6x533 mm, 9x533 mm, 13x533 mm, 30x533 mm



Cod	Lățime (mm)	Lungime totală (mm)	Granulație	Pentru modelul	Ambalare (buc./set)
P-43256	9	533	40	9032	5/1
P-43262	9	533	60	9032	5/1
P-43278	9	533	80	9032	5/1
P-43284	9	533	100	9032	5/1
P-43290	9	533	120	9032	5/1

Benzi abrazive 13x533 mm



Cod	Lățime (mm)	Lungime totală (mm)	Granulație	Pentru modelul	Ambalare (buc./set)
P-43321	13	533	40	9032	5/1
P-43337	13	533	60	9032	5/1
P-43343	13	533	80	9032	5/1
P-43359	13	533	100	9032	5/1
P-43365	13	533	120	9032	5/1
P-43387	13	533	240	9032	5/1

Benzi abrazive 30x533 mm



Cod	Lățime (mm)	Lungime totală (mm)	Granulație	Pentru modelul	Ambalare (buc./set)
A-23852	30	533	40	9031	10/1
A-23868	30	533	60	9031	10/1
A-23874	30	533	80	9031	10/1
A-23880	30	533	100	9031	10/1
A-23896	30	533	120	9031	10/1
P-36675	30	533	40	9031	5/1
P-36697	30	533	80	9031	5/1
P-36706	30	533	100	9031	5/1
P-36712	30	533	120	9031	5/1
P-36734	30	533	240	9031	5/1

Benzi de șlefuit sticlă

30x533 mm



Cod	Lățime (mm)	Lungime totală (mm)	Granulație	Pentru modelul	Ambalare (buc./set)
P-01395	30	533	40	9031	5/1
P-01404	30	533	60	9031	5/1
P-01199	30	533	80	9031	5/1
P-01208	30	533	100	9031	5/1
P-01214	30	533	120	9031	5/1
P-01236	30	533	180	9031	5/1

Plăci de plută pentru șlefuitoare



Cod	Descriere	Pentru modelul	Ambalare (buc./set)
421093-8	Placă de plută pentru șlefuitoare	9401, 9402	1
421646-3	Placă de plută pentru șlefuitoare	9403	1
423035-8	Placă de plută pentru șlefuitoare	9924DB	1
423312-8	Placă de plută pentru șlefuitoare	9903	1
423313-6	Placă de plută pentru șlefuitoare	9920	1
423314-4	Placă de plută pentru șlefuitoare	9404	1

Plăci de grafit







Cod	Descriere	Pentru modelul	Ambalare (buc./set)
424057-1	Placă de grafit pentru șlefuitoare	9403	1
423036-6	Placă de grafit pentru șlefuitoare	9924DB	1
423315-2	Placă de grafit pentru șlefuitoare	9903	1
423316-0	Placă de grafit pentru șlefuitoare	9920	1
423317-8	Placă de grafit pentru șlefuitoare	9404	1
A-86262	Placă de grafit pentru șlefuitoare	9401, 9402	1



Plăci de oțel și plută

Cod	Descriere	Pentru modelul	Ambalare (buc./set)
150980-1	Placă de oțel și plută	9403	2/1
151749-6	Placă oțel	9903	1
151751-9	Placă de oțel și plută	9403	2/1
341705-6	Placă oțel	9924DB	1
345503-0	Placă oțel	9910, 9911	1

Alte accesorii

	Cod	Descriere	Lățime (mm)	Pentru modelul	Ambalare (buc./set)
	125157-7	Braț frontal	6	9032, DBS180	1
	125158-5	Braț frontal	9	9032, DBS180	1
	125159-3	Braț frontal	13	9032, DBS180	1
	342152-4	Protecție alunecare	/	9030, 9031	1

DISCURI DE ȘLEFUIT PENTRU MAȘINI ORBITALE

Discuri de șlefuit 125 mm - 8 găuri pentru suprafețe nevopsite (roșu)

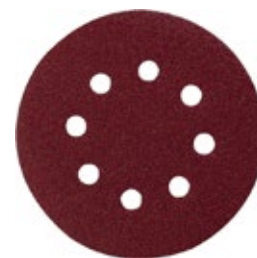

Cod	Diametru (mm)	Granulație	Număr de găuri	Prindere Velcro	Pentru modelul	Ambalare (buc./set)
P-43533	125	40	8	•	BO5010, BO5012, BO5030, BO5031, BO5020, BO5021, BO5041, DBO180	10/1
P-43549	125	60	8	•	BO5010, BO5012, BO5030, BO5031, BO5020, BO5021, BO5041, DBO180	10/1
P-43555	125	80	8	•	BO5010, BO5012, BO5030, BO5031, BO5020, BO5021, BO5041, DBO180	10/1
P-43642	125	80	8	•	BO5010, BO5012, BO5030, BO5031, BO5020, BO5021, BO5041, BBO180, DBO180	50/1
P-43561	125	100	8	•	BO5010, BO5012, BO5030, BO5031, BO5020, BO5021, BO5041, BBO180, DBO180	10/1
P-43577	125	120	8	•	BO5010, BO5012, BO5030, BO5031, BO5020, BO5021, BO5041, BBO180, DBO180	10/1
P-43583	125	180	8	•	BO5010, BO5012, BO5030, BO5031, BO5020, BO5021, BO5041, BBO180, DBO180	10/1
P-43599	125	240	8	•	BO5010, BO5012, BO5030, BO5031, BO5020, BO5021, BO5041, BBO180, DBO180	10/1
P-43608	125	320	8	•	BO5010, BO5012, BO5030, BO5031, BO5020, BO5021, BO5041, BBO180, DBO180	10/1
P-43614	125	400	8	•	BO5010, BO5012, BO5030, BO5031, BO5020, BO5021, BO5041, BBO180, DBO180	10/1

Discuri de șlefuit 125 mm - 8 găuri pentru suprafețe vopsite (alb)



Cod	Diametru (mm)	Granulație	Număr de găuri	Prindere Velcro	Pentru modelul	Ambalare (buc./set)
P-33342	125	40	8	•	BO5010, BO5012, BO5030, BO5031, BO5020, BO5021, BO5041, BBO180, DBO180	10/1
P-33358	125	60	8	•	BO5010, BO5012, BO5030, BO5031, BO5020, BO5021, BO5041, BBO180, DBO180	10/1
P-33364	125	80	8	•	BO5010, BO5012, BO5030, BO5031, BO5020, BO5021, BO5041, BBO180, DBO180	10/1

Cod	Diametru (mm)	Granulație	Număr de găuri	Prindere Velcro	Pentru modelul	Ambalare (buc./set)
P-33370	125	100	8	•	BO5010, BO5012, BO5030, BO5031, BO5020, BO5021, BO5041, BBO180, DBO180	10/1
P-33386	125	120	8	•	BO5010, BO5012, BO5030, BO5031, BO5020, BO5021, BO5041, BBO180, DBO180	10/1
P-33392	125	180	8	•	BO5010, BO5012, BO5030, BO5031, BO5020, BO5021, BO5041, BBO180, DBO180	10/1
P-33401	125	240	8	•	BO5010, BO5012, BO5030, BO5031, BO5020, BO5021, BO5041, BBO180, DBO180	10/1

Discuri abrazive 150 mm - 6 găuri pentru suprafețe nevopsite (roșu)

150 mm



Cod	Diametru (mm)	Granulație	Număr de găuri	Prindere Velcro	Pentru modelul	Ambalare (buc./set)
P-37471	150	40	6	•	BO6030, BO6040, BO6050	10/1
P-37487	150	60	6	•	BO6030, BO6040, BO6050	10/1
P-37493	150	80	6	•	BO6030, BO6040, BO6050	10/1
P-37502	150	100	6	•	BO6030, BO6040, BO6050	10/1
P-37518	150	120	6	•	BO6030, BO6040, BO6050	10/1
P-37524	150	180	6	•	BO6030, BO6040, BO6050	10/1
P-37530	150	240	6	•	BO6030, BO6040, BO6050	10/1
P-37546	150	320	6	•	BO6030, BO6040, BO6050	10/1
P-37552	150	400	6	•	BO6030, BO6040, BO6050	10/1

Discuri abrazive 150 mm - 6 găuri pentru suprafețe vopsite (alb)

150 mm



Cod	Diametru (mm)	Granulație	Număr de găuri	Prindere Velcro	Pentru modelul	Ambalare (buc./set)
P-37655	150	40	6	•	BO6030, BO6040, BO6050	10/1
P-37661	150	60	6	•	BO6030, BO6040, BO6050	10/1
P-37677	150	80	6	•	BO6030, BO6040, BO6050	10/1
P-37683	150	100	6	•	BO6030, BO6040, BO6050	10/1
P-37699	150	120	6	•	BO6030, BO6040, BO6050	10/1
P-37708	150	180	6	•	BO6030, BO6040, BO6050	10/1
P-37714	150	240	6	•	BO6030, BO6040, BO6050	10/1
P-37720	150	320	6	•	BO6030, BO6040, BO6050	10/1
P-37736	150	400	6	•	BO6030, BO6040, BO6050	10/1

Discuri abrazive 150 mm - 9 găuri pentru suprafețe nevopsite (roșu)



Cod	Diametru (mm)	Granulație	Număr de găuri	Prindere Velcro	Pentru modelul	Ambalare (buc./set)
P-31918	150	40	9	•	BO6030, BO6040, BO6050	10/1
P-31924	150	60	9	•	BO6030, BO6040, BO6050	10/1
P-31930	150	80	9	•	BO6030, BO6040, BO6050	10/1
P-31946	150	100	9	•	BO6030, BO6040, BO6050	10/1
P-31952	150	120	9	•	BO6030, BO6040, BO6050	10/1
P-31968	150	150	9	•	BO6030, BO6040, BO6050	10/1
P-31974	150	180	9	•	BO6030, BO6040, BO6050	10/1
P-31980	150	220	9	•	BO6030, BO6040, BO6050	10/1
P-31996	150	240	9	•	BO6030, BO6040, BO6050	10/1
P-32007	150	320	9	•	BO6030, BO6040, BO6050	10/1
P-32013	150	320	9	•	BO6030, BO6040, BO6050	10/1

Discuri abrazive 150 mm - 9 găuri pentru suprafețe vopsite (alb)



Cod	Diametru (mm)	Granulație	Număr de găuri	Prindere Velcro	Pentru modelul	Ambalare (buc./set)
P-37839	150	40	9	•	BO6030, BO6040, BO6050	10/1
P-37845	150	60	9	•	BO6030, BO6040, BO6050	10/1
P-37851	150	80	9	•	BO6030, BO6040, BO6050	10/1
P-37867	150	100	9	•	BO6030, BO6040, BO6050	10/1
P-37873	150	120	9	•	BO6030, BO6040, BO6050	10/1
P-37889	150	150	9	•	BO6030, BO6040, BO6050	10/1
P-37895	150	180	9	•	BO6030, BO6040, BO6050	10/1
P-37910	150	240	9	•	BO6030, BO6040, BO6050	10/1
P-37926	150	320	9	•	BO6030, BO6040, BO6050	10/1

HÂRTIE ABRAZIVĂ PENTRU MAȘINI DE ȘLEFUIT ALTERNATIV
Hârtie abrazivă 140x114 mm pentru suprafețe nevopsite (roșu)

Cod	Lățime (mm)	Lungime totală (mm)	Granulație	Pentru modelul	Ambalare (buc./set)
P-36398	114	140	40	BO4555, BO4557	10/1
P-32904	114	140	60	BO4555, BO4557	10/1
P-36407	114	140	80	BO4555, BO4557	10/1
P-32910	114	140	100	BO4555, BO4557	10/1
P-32926	114	140	120	BO4555, BO4557	10/1
P-32932	114	140	150	BO4555, BO4557	10/1
P-36413	114	140	180	BO4555, BO4557	10/1
P-36429	114	140	240	BO4555, BO4557	10/1

Hârtie abrazivă 102x114 mm - 6 găuri pentru suprafețe nevopsite (roșu)

Cod	Lățime (mm)	Lungime totală (mm)	Granulație	Număr de găuri	Prindere Velcro	Pentru modelul	Ambalare (buc./set)
P-33087	114	102	40	6	•	BO4555, BO4565	10/1
P-33093	114	102	60	6	•	BO4555, BO4565	10/1
P-33102	114	102	80	6	•	BO4555, BO4565	10/1
P-33118	114	102	100	6	•	BO4555, BO4565	10/1
P-33124	114	102	120	6	•	BO4555, BO4565	10/1
P-33130	114	102	150	6	•	BO4555, BO4565	10/1
P-33146	114	102	180	6	•	BO4555, BO4565	10/1
P-33152	114	102	240	6	•	BO4555, BO4565	10/1
P-33168	114	102	320	6	•	BO4555, BO4565	10/1

Hârtie abrazivă 102x114 mm - 6 găuri pentru suprafețe vopsite (alb)



Cod	Lățime (mm)	Lungime totală (mm)	Granulație	Număr de găuri	Prindere Velcro	Pentru modelul	Ambalare (buc./set)
P-35807	114	102	40	6	•	BO4555, BO4565	10/1
P-35813	114	102	60	6	•	BO4555, BO4565	10/1
P-35829	114	102	80	6	•	BO4555, BO4565	10/1
P-35835	114	102	100	6	•	BO4555, BO4565	10/1
P-35841	114	102	120	6	•	BO4555, BO4565	10/1
P-35857	114	102	150	6	•	BO4555, BO4565	10/1
P-35863	114	102	180	6	•	BO4555, BO4565	10/1
P-35879	114	102	240	6	•	BO4555, BO4565	10/1
P-35885	114	102	320	6	•	BO4555, BO4565	10/1

Hârtie abrazivă 230x93 mm - 8 găuri pentru suprafețe nevopsite (roșu)



Cod	Lățime (mm)	Lungime totală (mm)	Granulație	Pentru modelul	Pentru modelul	Ambalare (buc./set)
P-31837	93	228	40	8	BO3700, BO3710, BO3711	10/1
P-31843	93	228	60	8	BO3700, BO3710, BO3711	10/1
P-31859	93	228	80	8	BO3700, BO3710, BO3711	10/1
P-31865	93	228	100	8	BO3700, BO3710, BO3711	10/1
P-36011	93	228	120	8	BO3700, BO3710, BO3711	10/1
P-36027	93	228	150	8	BO3700, BO3710, BO3711	10/1
P-36033	93	228	180	8	BO3700, BO3710, BO3711	10/1
P-36049	93	228	240	8	BO3700, BO3710, BO3711	10/1

Hârtie abrazivă 185x93 mm - 8 găuri cu Velcro pentru suprafețe nevopsite (roșu)



Cod	Lățime (mm)	Lungime totală (mm)	Granulație	Număr de găuri	Prindere Velcro	Pentru modelul	Ambalare (buc./set)
P-31871	93	185	40	8	•	BO3700, BO3710, BO3711	10/1
P-31902	93	185	100	8	•	BO3700, BO3710, BO3711	10/1
P-35916	93	185	180	8	•	BO3700, BO3710,	10/1

Hârtie abrazivă 185x93 mm - 8 găuri cu Velcro pentru suprafețe vopsite (alb)

Cod	Lățime (mm)	Lungime totală (mm)	Granulație	Număr de găuri	Prindere Velcro	Pentru modelul	Ambalare (buc./set)
E-23494	80	130	40	8	•	-	10/1
E-23503	80	130	60	8	•	-	10/1
E-23519	80	130	A80	8	•	-	10/1
E-23525	80	130	100	8	•	-	10/1
E-23531	80	130	120	8	•	-	10/1
E-19629	93	185	40	8	•	BO3700, BO3710, BO3711	10/1
E-19635	93	185	60	8	•	BO3700, BO3710, BO3711	10/1
E-19641	93	185	80	8	•	BO3700, BO3710, BO3711	10/1
E-19657	93	185	100	8	•	BO3700, BO3710, BO3711	10/1
E-19663	93	185	120	8	•	BO3700, BO3710, BO3711	10/1
E-19679	93	185	150	8	•	BO3700, BO3710, BO3711	10/1
E-19685	93	185	180	8	•	BO3700, BO3710, BO3711	10/1
E-19691	93	185	240	8	•	BO3700, BO3710, BO3711	10/1

Plasă abrazivă

Cod	Lățime (mm)	Lungime totală (mm)	Granulație	Ambalare (buc./set)
D-78835	93	185	80	10/1
D-78841	93	185	120	10/1
D-78857	93	185	180	10/1
D-78863	93	185	240	10/1
D-78879	93	185	320	10/1

Pad pentru plasă abrazivă

Cod	Lățime (mm)	Lungime totală (mm)	Ambalare (buc./set)
D-78885	93	185	2/1

Hârtie abrazivă 229x115 mm-14 găuri cu Velcro pentru suprafețe nevopsite (roșu)



Cod	Lățime (mm)	Lungime totală (mm)	Granulație	Număr de găuri	Prindere Velcro	Pentru modelul	Ambalare (buc./set)
P-43022	115	229	40	14	•	BO4900V, 9046	10/1
P-43038	115	229	60	14	•	BO4900V, 9046	10/1
P-43050	115	229	100	14	•	BO4900V, 9046	10/1

Hârtie abrazivă delta 94x94x94 mm - 6 găuri cu Velcro pentru suprafețe nevopsite (roșu)



Cod	Granulație	Număr de găuri	Dimensiuni (LxIxH) (mm)	Prindere Velcro	Pentru modelul	Ambalare (buc./set)
P-33261	60	6	94 x 94 x 94	•	BO4565	10/1
P-33277	80	6	94 x 94 x 94	•	BO4565	10/1
P-33283	100	6	94 x 94 x 94	•	BO4565	10/1
P-33299	120	6	94 x 94 x 94	•	BO4565	10/1

Hârtie abrazivă delta 94x94x94 mm - 6 găuri cu Velcro pentru suprafețe vopsite (alb)



Cod	Granulație	Număr de găuri	Dimensiuni (LxIxH) (mm)	Prindere Velcro	Pentru modelul	Ambalare (buc./set)
P-42709	80	6	94 x 94 x 94	•	BO4565	10/1
P-42721	120	6	94 x 94 x 94	•	BO4565	10/1
P-42737	150	6	95 x 95 x 95	•	BO4565	10/1

Hârtie abrazivă delta 100x150 mm - 7 găuri cu Velcro pentru suprafețe vopsite (alb)



Cod	Granulație	Număr de găuri	Dimensiuni (LxIxH) (mm)	Prindere Velcro	Pentru modelul	Ambalare (buc./set)
E-23422	60	7	100x150	•	BO006CG	10/1
E-23438	80	7	100x150	•	BO006CG	10/1
E-23444	100	7	100x150	•	BO006CG	10/1
E-23450	120	7	100x150	•	BO006CG	10/1

Perii abrazive

Ajută la prelucrarea precisă a diferitelor materiale. Periile abrazive permit prelucrarea suprafețelor cu mașini de înșurubat cu turație variabilă. Datorită formei pe care o au periile permit prelucrarea unor materiale cu forme diferite precum țevi circulare sau dreptunghiulare.

















Cod	Diametru (mm)	Lățime (mm)	Turație maximă (min ⁻¹)	Granulație	Tijă de prindere (mm)	Ambalare (buc./set)
B-36865	50,8	25,4	15.300	40	6	1
B-36968	50,8	50,8	15.300	40	6	1
B-37013	63,5	25,4	12.700	40	6	1
B-37063	76	25,4	10.000	40	6	1
B-37116	76	50,8	10.000	40	6	1
B-36871	50,5	25,4	15.300	60	6	1
B-36974	50,8	50,8	15.300	60	6	1
B-37029	63,5	25,4	12.700	60	6	1
B-37079	76	25,4	10.000	60	6	1
B-37122	76	50,8	10.000	60	6	1
B-36980	50,8	50,8	15.300	80	6	1
B-37035	63,5	25,4	12.700	80	6	1
B-37085	76	25,4	10.000	80	6	1
B-37138	76	50,8	10.000	80	6	1
B-36893	50,8	25,4	15.300	120	6	1
B-36946	50,8	38,1	15.300	120	6	1
B-36996	50,8	50,8	15.300	120	6	1
B-37041	63,5	25,4	12.700	120	6	1
B-37091	76	25,4	10.000	120	6	1
B-37144	76	50,8	10.000	120	6	1
B-36902	50,8	25,4	15.300	180	6	1
B-36952	50,8	38,1	15.300	180	6	1
B-37007	50,8	50,8	15.300	180	6	1
B-37057	63,5	25,4	12.700	180	6	1
B-37100	76	25,4	10.000	180	6	1
B-37150	76	50,8	10.000	180	6	1
B-36843	38	25	/	100	6	1
B-36837	38	25	/	80	6	1
B-36784	25	25	/	80	6	1
B-36790	25	25	/	120	6	1
B-36859	38	25	/	180	6	1
B-36821	38	25	/	60	6	1
B-36815	38	25	/	40	6	1
B-36778	25	25	/	60	6	1

Freze cu carbură de tungsten

Frezele cu carbură sunt utilizate la scară largă în producția industrială. Vârful din carbură de tungsten permite frezarea de 10 ori mai rapidă și durată de viață de 200 de ori mai mare decât frezele convenționale. Există 5 forme de cap diferite pe care le puteți utiliza în scopuri diferite, cum ar fi prelucrarea suprafețelor interioare curbate sau dreptunghiulare, îndepărtarea bavurilor sau urmelor de sudură.



	Cod	Descriere	Dimensiune (mm)	Tijă de prindere (mm)	Potrivit pentru	Ambalare (buc./set)
	B-52716	Freză standard A cu carbură de tungsten	10x20	6	metale, oțel inoxidabil	1
	B-52722	Freză standard A cu carbură de tungsten	10x20	6	metale, oțel inoxidabil	1
	B-52738-10	Freză standard A cu carbură de tungsten	10x20	6	metale neferoase	10/1
	B-52744-10	Freză standard C cu carbură de tungsten	10x20	6	metale, oțel inoxidabil	10/1
	B-52750	Freză standard C cu carbură de tungsten	10x20	6	metale, oțel inoxidabil	1
	B-52772	Freză standard F cu carbură de tungsten	10x20	6	metale, oțel inoxidabil	1
	B-52788	Freză standard F cu carbură de tungsten	10x20	6	metale, oțel inoxidabil	1
	B-52794-10	Freză standard F cu carbură de tungsten	10x20	6	metale neferoase	10/1
	B-52803	Freză standard L cu carbură de tungsten	10x25	6	metale, oțel inoxidabil	1
	B-52819	Freză standard L cu carbură de tungsten	10x25	6	metale, oțel inoxidabil	1
	B-52825-10	Freză standard L cu carbură de tungsten	10x25	6	metale neferoase	10/1
	B-52831	Freză standard M cu carbură de tungsten	10x20	6	metale, oțel inoxidabil	1
	B-52847-10	Freză standard M cu carbură de tungsten	10x20	6	metale, oțel inoxidabil	10/1
	B-52853-10	Freză standard M cu carbură de tungsten	10x20	6	metale neferoase	10/1

Pietre pentru șlefuit inox



Cod	Descriere	Dimensiune (mm)	Tijă de prindere (mm)	Potrivit pentru	Ambalare (buc./set)
199105-2	Piatră șlefuit inox WA60 19x28x6 2B	19	6	metale, oțel inoxidabil	2/1
794059-4	Piatră șlefuit inox A60 10x10x3 10B	10	3	metale, oțel inoxidabil	10/1
794057-8	Piatră șlefuit inox WA60 10x13x3 10B	10	3	metale, oțel inoxidabil	10/1

Bucșe de prindere și piulițe

	Cod	Descriere	Diametru (mm)	Pentru modelul	Ambalare (buc./set)
	763620-8	Bucșă elastică	6	906, GD0601, GD0603	1
	763627-4	Bucșă elastică	3	906, GD0601, GD0603	1
	763664-8	Piuliță portsculă	6	GD0601	1
	763668-0	Piuliță portsculă	8	GD0602, BGD800, DGD800	1
	763670-3	Bucșă elastică	6	GD0602, BGD800, DGD800	1
	763236-9	Piuliță portsculă	6	GD0603	1
	763645-2	Piuliță portsculă	6	GD0800C	1
	192988-9	Bucșă elastică și piuliță portsculă	8	GD0800C, GD0810C	2/1
	193011-3	Bucșă elastică și piuliță portsculă	3	GD0800C, GD0810C	2/1
	193012-1	Bucșă elastică și piuliță portsculă	6	GD0800C, GD0810C	2/1

ALTE ACCESORII PENTRU POLIZOARE

Accesorii

	Cod	Descriere	Lungime totală (mm)	Lățime (mm)	Pentru modelul	Ambalare (buc./set)
	192523-3	Placă de perforat	280	115	BO4900V, 9046	1
	192694-6	Cleme de prindere	/	/	9910, 9911	1
	192989-7	Placă de ștanțare	185	93	BO3700, BO3710, BO3711	1
	194930-6	Talpă cu arici	185	93	BO3700, BO3710, BO3711	1
	140441-9	Talpă burete	/	/	BO3700, BO3710, BO3711	1
	450066-4	Placă ștanțare	102	114	BO4555, BO4556, BO4557	1

ACCESORII PENTRU ȘLEFUIT

Discuri de șlefuit 180 mm

180 mm



Cod	Diametru (mm)	Granulație	Prindere Velcro	Pentru modelul	Ambalare (buc./set)
P-33439	180	40	•	PV7000C, 9207SPB, 9227CB, SA7000C	10/1
P-33445	180	80	•	PV7000C, 9207SPB, 9227CB, SA7000C	10/1
P-33451	180	120	•	PV7000C, 9207SPB, 9227CB, SA7000C	10/1
P-38059	180	240	•	PV7000C, 9207SPB, 9227CB, SA7000C	10/1
P-38065	180	320	•	PV7000C, 9207SPB, 9227CB, SA7000C	10/1
P-38071	180	360	•	PV7000C, 9207SPB, 9227CB, SA7000C	10/1
P-38087	180	400	•	PV7000C, 9207SPB, 9227CB, SA7000C	10/1
P-38093	180	500	•	PV7000C, 9207SPB, 9227CB, SA7000C	10/1

Foi abrazive - oxid aluminiu

Foile de șlefuit abrazive sunt fabricate din fibre și rășină, cu granule abrazive din oxid de aluminiu iar suportul este realizat din fibră de sticlă. Potrivite pentru utilizarea cu plăcile de suport din cauciuc. Aplicații: îndepărtarea ruginii, vopselurilor și lacurilor, tratarea și nivelarea sudurilor și polizarea marginilor.







Cod	Diametru (mm)	Alezaj (mm)	Granulație	Pentru modelul	Ambalare (buc./set)
P-00854	115	22,23	16	polizoare 115mm	5/1
P-00907	115	22,23	60	polizoare 115mm	5/1
P-00957	125	22,23	24	polizoare 125mm	5/1
P-00963	125	22,23	36	polizoare 125mm	5/1
P-00979	125	22,23	40	polizoare 125mm	5/1
P-01024	180	22,23	16	polizoare 180mm	5/1
P-01030	180	22,23	24	polizoare 180mm	5/1
P-01052	180	22,23	40	polizoare 180mm	5/1







Discuri de suport din cauciuc pentru foi de șlefuit









Cod	Diametru (mm)	Prindere	Pentru modelul	Ambalare (buc./set)
P-05882	115	M14	polizoare 115 mm	1
P-05898	125	M14	polizoare 125 mm	1
P-05913	180	M14	polizoare 180 mm	1

Paduri pentru lustruit

	Cod	Descriere	Diametru (mm)	Prindere Velcro	Pentru modelul	Ambalare (buc./set)
	192629-7	Pad lustruit din lână	180 mm	•	PV7000C, 9227CB, 9237CB, SA7000C	1
	197894-3	Pad burete pentru aplicarea cerii	150 mm	•	PO6000C, DPO600	1
	197897-7	Calotă de lână pentru lustruit ceara	125 mm	•	PO5000C	1
	199424-6	Calotă de lână pentru lustruit ceara	150 mm	•	DPO600	1
	794176-0	Calotă de lână pentru lustruirea lemnului	180		9237CB, PV7000C, SA7000C	1

	Cod	Descriere	Diametru (mm)	Prindere Velcro	Pentru modelul	Ambalare (buc./set)
	794558-6	Pad din burete pentru lustruit	125		BO5031, BO5041	1
	794560-9	Calotă de lână pentru lustruit ceara	140	•	BO5031, BO5041	1
	794618-4	Pad pentru lustruit pentru îndepărtarea cerii	150	•	BO6030, BO6040, BO6050	1
	P-21727	Pad buretat de mare densitate pentru lustruire vopsea	150	•	9227CB, 9237CB, 9565CVL, BO6040, PV7000C, SA7000C	1
	P-21733	Pad burete moale pentru lustruit	150	•	9227CB, 9237CB, 9565CVL, BO6040, PV7000C, SA7000C	1
	P-21749	Pad burete portocaliu pentru lustruit	150	•	9227CB, 9237CB, 9565CVL, BO6040, PV7000C, SA7000C	1

Plăci de suport

	Cod	Descriere	Diametru (mm)	Prindere Velcro	Pentru modelul	Ambalare (buc./set)
	743053-3	Suport pentru lustruit 180 mm	165 x M14	•	9227CB, 9237CB, PV7000C, SA7000C	1
	P-21777	Taler cu scai pentru burete 120 mm	120	•	9565CVL, 9565CVR, 9227CB, SA7000C	1
	743060-6	Pad suport pentru lustruit	125	•	9565CVL, 9565CVR, SA5040	1
	743081-8	Placă suport pentru hârtie abrazivă	125	•	BBO180, DBO180, BO5010, BO5012, BO5030, BO5031, BO5020, BO5021, BO5041	1
	196684-1	Placă suport pentru lustruit	150	•	BO6030, BO6040	1
	196685-9	Talpă lustruire	150	•	BO6030, BO6040	1

	Cod	Descriere	Diametru (mm)	Prindere Velcro	Pentru modelul	Ambalare (buc./set)
	196686-7	Placă suport cauciucată, extrem de flexibilă	150	•	BO6030, BO6040	1
	197314-7	Placă suport cauciucată, moale	150	•	BO6050	1
	197315-5	Placă suport din cauciuc dur	150	•	BO6050	1
	197316-3	Placă suport din cauciuc extrem de moale	150	•	BO6050	1
	197922-4	Placă suport din cauciuc dur	125	•	PO6000C, DPO600	1
	197928-2	Placă suport din cauciuc dur	150	•	PO6000C, DPO600	1
	224515-5	Piuliță de strângere	M14 x 2 (DIN)		SA7000C, SA7000, GV7000C	1
	191Y22-2	Pad triunghiular cu velcro	/	•	DBO480, DBO481, DBO482, DBO484	1
	191Y23-0	Pad rectangular cu velcro	/	•	DBO480, DBO481, DBO482, DBO484	1
	191Y24-8	Pad pătrat cu velcro	/	•	DBO480, DBO481, DBO482, DBO484	1
	191Y25-6	Pad pătrat cu cleme	/	•	DBO480, DBO481, DBO482, DBO484	1

PERII ABRAZIVE PENTRU MAȘINA DE ȘLEFUIT 9741

Perii din nailon

Sunt recomandate pentru prelucrarea lemnului moale și finisarea lemnului dur, oțelului inoxidabil și aluminiului.



Cod	Diametru (mm)	Lățime (mm)	Granulație	Pentru modelul	Ambalare (buc./set)
P-04422	100	120	60	9741	1
794384-3	100	120	80	9741	1
P-04438	100	120	80	9741	1
P-04444	100	120	120	9741	1
P-04450	100	120	180	9741	1

Perii de pâslă

Pentru prelucrarea precisă a oțelului inoxidabil și șlefuirea fină a suprafețelor din lemn.



Cod	Diametru (mm)	Lățime (mm)	Granulație	Pentru modelul	Ambalare (buc./set)
P-18035	100	120	80	9741	1
P-18041	100	120	120	9741	1
P-18029	100	120	180	9741	1



Perii de pâslă și lână





Pentru prelucrarea precisă a oțelului inoxidabil și șlefuirea fină a suprafețelor din lemn.



Cod	Diametru (mm)	Lățime (mm)	Granulație	Pentru modelul	Ambalare (buc./set)
P-18057	100	120	80	9741	1
P-19233	100	120	120	9741	1
P-19249	100	120	180	9741	1

Alte perii de lustruit

	Cod	Descriere	Diametru (mm)	Lățime (mm)	Granulație	Descriere în detaliu	Ambalare (buc./set)
	794381-9	Rolă de bumbac pentru lustruit	100	120	/	Recomandată pentru lustruirea suprafețelor metalice	1
	P-01127	Perie lamelară pentru lustruit	100	120	40	Perie lamelară potrivită pentru șlefuirea vopselurilor și lucrări de finisare	1

	Cod	Descriere	Diametru (mm)	Lățime (mm)	Granulație	Descriere în detaliu	Ambalare (buc./set)
	P-01155	Perie lamelară pentru lustruit	100	120	80	Perie lamelară potrivită pentru șlefuirea vopselurilor și lucrări de finisare.	1
	P-04400	Perie de sârmă	100	120	/	Peria are fire cu diametru 0,3 mm și este potrivită pentru eliminarea vopselei și ruginii și curățarea betonului.	1
	P-04416	Perie pentru finisare	100	120	/	Este potrivită pentru îndepărtarea vopselurilor și lacurilor și pentru finisarea suprafețelor.	1
	P-65648	Perie din oțel alămit	100	120	/	Peria cu fir de oțel alămit de diametru 0,3 mm este potrivită pentru prelucrarea suprafețelor lemnoase, pentru îndepărtarea ruginii și curățare.	1

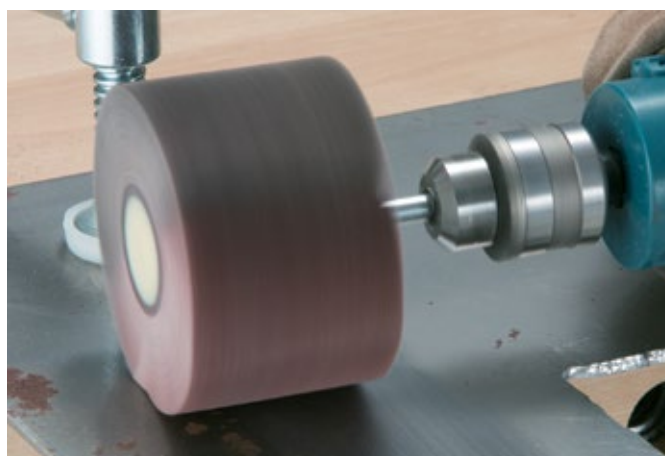

ACCESORII PENTRU FREZARE ȘI RINDELUIRE

Aluminiu



Lemn



Plăci laminate

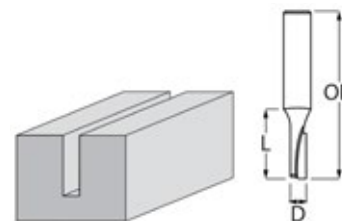

Freze pentru caneluri cu o singură lamă

Cod	Turație maximă (min ⁻¹)	Prindere	Lățime (D) (mm)	Lungime (OL) (mm)	Lungime de lucru (L) (mm)	Numar lame	Pentru modelul	Ambalare (buc./set)
D-47379	28.000	8 mm	3	51	13	1	RT0700C, RP0900, RP1110C, RP1800FX, RP1801FX, RP2300FC, RP2301FC	1
D-47385	28.000	8 mm	4	51	13	1	RT0700C, RP0900, RP1110C, RP1800FX, RP1801FX, RP2300FC, RP2301FC	1
D-47391	28.000	8 mm	5	48	13	1	RT0700C, RP0900, RP1110C, RP1800FX, RP1801FX, RP2300FC, RP2301FC	1
D-47400	28.000	8 mm	6	50,8	19	1	RT0700C, RP0900, RP1110C, RP1800FX, RP1801FX, RP2300FC, RP2301FC	1
D-47416	28.000	6 mm	6	50,8	19	1	RT0700C, RP0900, RP1110C, RP1800FX, RP1801FX, RP2300FC, RP2301FC	1

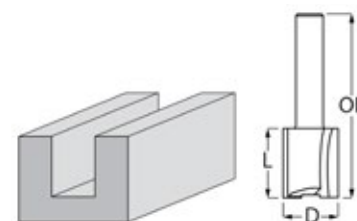
Freze pentru caneluri cu 2 lame

Cod	Lungime (OL) (mm)	Lățime (D) (mm)	Lungime de lucru (L) (mm)	Prindere	Număr lame	Turație maximă (min ⁻¹)	Pentru modelul	Ambalare (buc./set)
D-47444	51	8	19	6 mm	2	28.000	RT0700C, RP1800FX, RP1801FX, RP2300FC, RP2301FC	1
D-47503	48	6	16	8 mm	2	28.000	RT0700C, RP0900, RP1110C, RP1800FX, RP1801FX, RP2300FC, RP2301FC	1
D-47525	51	8	19	8 mm	2	28.000	RT0700C, RP0900, RP1110C, RP1800FX, RP1801FX, RP2300FC, RP2301FC	1
D-47531	51	10	19	8 mm	2	28.000	RT0700C, RP0900, RP1110C, RP1800FX, RP1801FX, RP2300FC, RP2301FC	1
D-47547	51	12	19	8 mm	2	28.000	RT0700C, RP0900, RP1110C, RP1800FX, RP1801FX, RP2300FC, RP2301FC	1
D-47569	55,7	12,7	19	8 mm	2	24.000	RT0700C, RP1110C, RP1800FX, RP1801FX, RP2300FC, RP2301FC	1
D-47684	73	25	32	12 mm	2	18.000	RP2300FC, RP2301FC	1

Freze de nivelare cu 2 lame

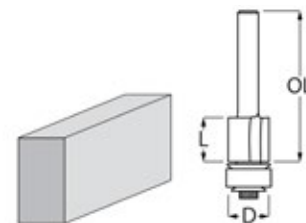

Cod	Lungime (OL) (mm)	Lățime (D) (mm)	Lungime de lucru (L) (mm)	Prindere	Număr de lame	Turație maximă (min ⁻¹)	Diametru rulment (H) (mm)	Pentru modelul	Ambalare (buc./set)
D-47709	56	12,7	13	6 mm	2	28.000	12,7	RT0700C, RP1800FX, RP1801FX, RP2300FC, RP2301FC	1
D-47721	67	9,5	26	8 mm	2	24.000	9,5	RT0700C, RP1110C, RP1800FX, RP1801FX, RP2300FC, RP2301FC	1
D-47737	55,7	12,7	13	8 mm	2	28.000	12,7	RT0700C, RP0900, RP1110C, RP1800FX, RP1801FX, RP2300FC, RP2301FC	1
D-47743	68,5	12,7	26	8 mm	2	24.000	12,7	RT0700C, RP1110C, RP1800FX, RP1801FX, RP2300FC, RP2301FC	1

Freze de nivelare cu 3 lame

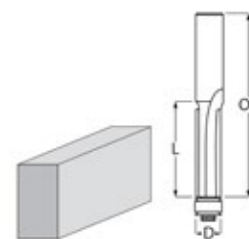

Cod	Lungime (OL) (mm)	Lățime (D) (mm)	Lungime de lucru (L) (mm)	Prindere	Număr de lame	Turație maximă (min ⁻¹)	Diametru rulment (H) (mm)	Pentru modelul	Ambalare (buc./set)
D-47765	91,4	12,7	38	12 mm	3	24.000	9,5	RP1800FX, RP1801FX, RP2300FC, RP2301FC	1

Freze laterale

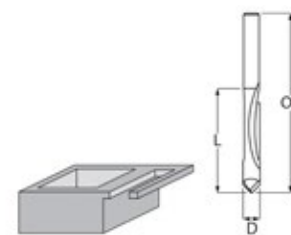

Cod	Lungime (OL) (mm)	Lățime (D) (mm)	Lungime de lucru (L) (mm)	Prindere	Număr de lame	Turație maximă (min ⁻¹)	Pentru modelul	Ambalare (buc./set)
D-47771	65	6,35	19	6 mm	1	28.000	RT0700C, RP1800FX, RP1801FX, RP2300FC, RP2301FC	1
D-47787	65	6,35	19	8 mm	1	28.000	RT0700C, RP0900, RP1110C, RP1800FX, RP1801FX, RP2300FC, RP2301FC	1
D-47793	75	9,5	26	12 mm	1	24.000	RP1800FX, RP1801FX, RP2300FC, RP2301FC	1

Freze pentru șanțuri tip V

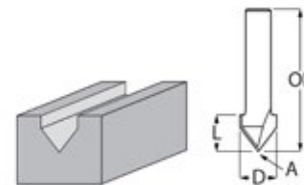

Cod	Lungime (OL) (mm)	Lățime (D) (mm)	Lungime de lucru (L) (mm)	Rază (R) (mm)	Prindere	Număr de lame	Turație maximă (min ⁻¹)	Pentru modelul	Ambalare (buc./set)
D-47896	44,7	12,7	12,7	90	8 mm	2	28.000	RT0700C, RP0900, RP1110C, RP1800FX, RP1801FX, RP2300FC, RP2301FC	1
D-47927	50,8	15,9	12,7	90	12 mm	2	24.000	RP1800FX, RP1801FX, RP2300FC, RP2301FC	1
D-47955	60,3	28,6	22,2	90	12 mm	2	18.000	RP2300FC, RP2301FC	1

Freze pentru șanțuri tip U

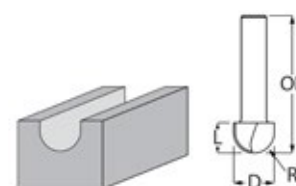

Cod	Lungime (OL) (mm)	Lățime (D) (mm)	Lungime de lucru (L) (mm)	Rază (R) (mm)	Prindere	Număr de lame	Turație maximă (min ⁻¹)	Pentru modelul	Ambalare (buc./set)
D-48000	41,5	12,7	10	6,35	8 mm	2	28.000	RT0700C, RP0900, RP1110C, RP1800FX, RP1801FX, RP2300FC, RP2301FC	1
D-48016	44,5	15,8	12,7	7,9	8 mm	2	24.000	RT0700C, RP1110C, RP1800FX, RP1801FX, RP2300FC, RP2301FC	1

Freze pentru îmbinări

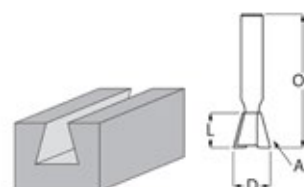

Cod	Lungime (OL) (mm)	Lățime (D) (mm)	Lungime de lucru (L) (mm)	Unghi (A) (°)	Prindere	Număr de lame	Turație maximă (min ⁻¹)	Pentru modelul	Ambalare (buc./set)
D-48072	45	12,7	13	14	8 mm	2	28.000	RT0700C, RP0900, RP1110C, RP1800FX, RP1801FX, RP2300FC, RP2301FC	1
D-48103	64	25,4	22,2	14	12 mm	2	18.000	RP2300FC, RP2301FC	1

Freze rotunjite cu rulment

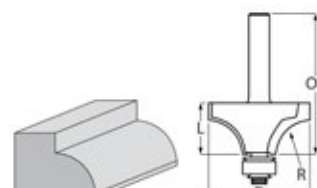

Cod	Lungime (OL) (mm)	Lățime (D) (mm)	Lungime de lucru (L) (mm)	Rază (R) (mm)	Prindere	Număr de lame	Turație maximă (min ⁻¹)	Diametru rulment (H) (mm)	Ambalare (buc./set)
D-48343	51	17,3	8	2,3	8 mm	2	24.000	12,7	1
D-48359	53,4	19	9,5	3,2	8 mm	2	24.000	12,7	1

Cod	Lungime (OL) (mm)	Lățime (D) (mm)	Lungime de lucru (L) (mm)	Rază (R) (mm)	Prindere	Număr de lame	Turație maximă (min ⁻¹)	Diametru rulment (H) (mm)	Ambalare (buc./set)
D-48387	56,5	25,4	13,5	6,35	8 mm	2	18.000	12,7	1
D-48393	57,3	28,6	14,5	7,9	8 mm	2	18.000	12,7	1
D-48402	59,7	31,8	16,7	9,5	8 mm	2	18.000	12,7	1
D-48418	62	38,1	19	12,7	8 mm	2	16.000	12,7	1
D-48424	76,2	50,8	25,4	19	12 mm	2	14.000	12,7	1

Freze cu profil rotunjit cu rulment

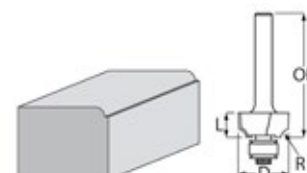

Cod	Lungime (OL) (mm)	Lățime (D) (mm)	Lungime de lucru (L) (mm)	Rază (R) (mm)	Prindere	Număr de lame	Turație maximă (min ⁻¹)	Diametru rulment (H) (mm)	Ambalare (buc./set)
D-48430	49,1	17	8	2,3	6 mm	2	24.000	9,5	1
D-48446	51,6	19	9,5	3,2	6 mm	2	24.000	9,5	1
D-48527	54,7	25,4	13,5	6,35	8 mm	2	18.000	9,5	1
D-48549	57,9	31,8	17	9,5	8 mm	2	18.000	9,5	1
D-48555	60,2	38,1	19	12,7	8 mm	2	16.000	9,5	1
D-48561	74,5	50,8	25,4	19	12 mm	2	14.000	9,5	1

Freze cu margini duble

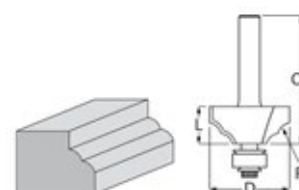

Cod	Lungime (OL) (mm)	Lățime (D) (mm)	Lungime de lucru (L) (mm)	Rază (R) (mm)	Prindere	Număr de lame	Turație maximă (min ⁻¹)	Diametru rulment (H) (mm)	Ambalare (buc./set)
D-48577	50,8	28,6	12,7	4	8 mm	2	18.000	12,7	1

Freze rotunjite pentru caneluri cu rulment

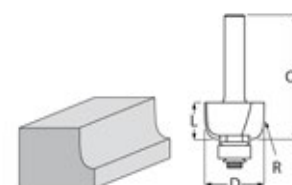

Cod	Lungime (OL) (mm)	Lățime (D) (mm)	Lungime de lucru (L) (mm)	Rază (R) (mm)	Prindere	Număr de lame	Turație maximă (min ⁻¹)	Diametru rulment (H) (mm)	Ambalare (buc./set)
D-48614	55,6	22,2	12,7	4,8	8 mm	2	24.000	12,7	1
D-48620	55,5	28,6	12,7	7,9	8 mm	2	18.000	12,7	1
D-48636	56	31,8	14	9,5	8 mm	2	18.000	12,7	1

Freze pentru muchii cu rulment

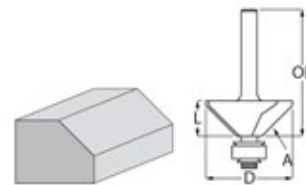

Cod	Lungime (OL) (mm)	Lățime (D) (mm)	Lungime de lucru (L) (mm)	Unghi (A) (°)	Prindere	Număr de lame	Turație maximă (min ⁻¹)	Diametru rulment (H) (mm)	Ambalare (buc./set)
D-48658	51	25,4	11	45	6 mm	2	18.000	12,7	1
D-48686	55,1	31,8	13,5	45	8 mm	2	18.000	12,7	1
D-48692	58,8	34,9	16	45	8 mm	2	16.000	12,7	1
D-48701	58,9	41,3	20	45	8 mm	2	16.000	12,7	1
D-48723	70,9	50,8	27	45	12 mm	2	14.000	12,7	1

Freze pentru profile cu rulment

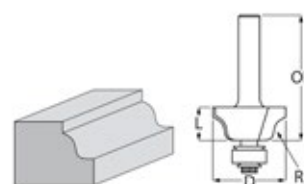

Cod	Lungime (OL) (mm)	Lățime (D) (mm)	Lungime de lucru (L) (mm)	Rază (R) (mm)	Prindere	Număr de lame	Turație maximă (min ⁻¹)	Diametru rulment (H) (mm)	Ambalare (buc./set)
D-48751	55,3	28,6	13	4	8 mm	2	18.000	12,7	1

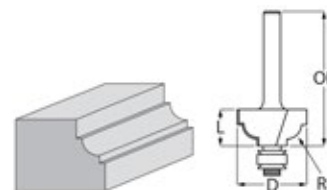

Freze pentru profile cu rulment







Cod	Lungime (OL) (mm)	Lățime (D) (mm)	Lungime de lucru (L) (mm)	Rază (R) (mm)	Prindere	Număr de lame	Turație maximă (min ⁻¹)	Diametru rulment (H) (mm)	Ambalare (buc./set)
D-48795	53,7	25,4	12,7	4,8	6 mm	2	18.000	12,7	1

Seturi de freze























	Cod	Descriere	Prindere	Ambalare (buc./set)
	D-57065	Set 12 freze	6 mm	1
	D-53534	Set 4 freze	8 mm	1

	Cod	Descriere	Prindere	Ambalare (buc./set)
	D-53540	Set 6 freze	8 mm	1
	D-53556	Set 12 freze	8 mm	1
	D-74778	Set 22 freze	8 mm	1
	D-74784	Set 22 freze	8 mm	1

ACCESORII DE FREZAT

Bucșe de prindere, piulițe și freze

	Cod	Descriere	Diametru (mm)	Pentru modelul	Ambalare (buc./set)
	763601-2	Bucșă elastică și piuliță portsculă	12	3600B	2/1
	763615-1	Piuliță portsculă	/	3608B	1
	763629-0	Piuliță portsculă	/	3612, 3612C, RP1800, RP1801, RP2300, RP2301	1
	763622-4	Bucșă elastică	12,7	3612, 3612C, RP1800,0RP1801, RP2300, RP2301	1
	763803-0	Bucșă elastică	6,35	3612BR	1
	763618-5	Bucșă elastică	8	3620, RP0900, RT0700C	1

	Cod	Descriere	Diametru (mm)	Pentru modelul	Ambalare (buc./set)
	763636-3	Bucșă elastică	6	3620, RP0900, RT0700C	1
	324149-5	Bucșă elastică	3,18	3706	1
	763608-8	Bucșă elastică	6,35	3706	1
	763607-0	Bucșă elastică	6	3706, 3708	1
	193483-2	Vârf de frezat în lemn și plastic	3,18	3706, DCO180	1
	733232-1	Vârf de frezat gips-carton	6,35	3706, DCO180	1
	733240-2	Vârf de frezat în lemn și plastic	3,18	3706, DCO180	1
	763661-4	Piuliță portsculă	6	3709, 3710	1
	763662-2	Bucșă elastică	6	3709, 3710	1
	763663-0	Bucșă elastică	6,35	3709, 3710	1
	763606-2	Piuliță portsculă	6	906	1
	763675-3	Piuliță portsculă	/	DCO180	1
	763676-1	Manșon de prindere	6,35	DCO180	1
	763677-9	Manșon de prindere	3,18	DCO180	1
	763678-7	Manșon de prindere	6	DCO180	1

	Cod	Descriere	Diametru (mm)	Pentru modelul	Ambalare (buc./set)
	763679-5	Manșon de prindere	3	DCO180	1
	193178-7	Bucșă elastică și piuliță portsculă	8	RP0910, RP1110C	2/1
	193180-0	Bucșă elastică și piuliță portsculă	6	RP0910, RP1110C	2/1
	763674-5	Piuliță portsculă	/	RP1800	1
	763628-2	Bucșă elastică	12	RP1800, RP1801, RP2300, RP2301FCX, 3612, 3612C	1
	763801-4	Manșon de prindere	6	RP1800, RP1801, RP2300, RP2301FCX, 3612, 3612C	1
	763804-8	Manșon de prindere	8	RP1800, RP1801, RP2300, RP2301FCX, 3612, 3612C	1
	763807-2	Manșon de prindere	10	RP1800, RP1801, RP2300, RP2301FCX, 3612, 3612C	1
	763637-1	Bucșă elastică	6,35	RT0700C, RP0900	1







Șablon copiere



Cod	Diametru (mm)	Diametru gaură (mm)	Lățime (mm)	Pentru modelul	Ambalare (buc./set)
321492-3	35	30	7	3612, RP0900, RP1800F, RP1801F, RP2300FC, RP2301FC, RT0700C, M3600, M3601	1
343577-5	10	8	10	3707, 3708, 3708F, RT0700C	1
193332-3	12	10,5	14	RP1110C	1
193335-7	20	18	13	RP1110C	1
193336-5	27	24	13	RP1110C	1
193339-9	40	37	13	RP1110C	1

Cod	Diametru (mm)	Diametru gaură (mm)	Lățime (mm)	Pentru modelul	Ambalare (buc./set)
193340-4	24	22	13	RP1110C	1
163080-8	29	25	15	RP1800FX, RP2300FCX, 3612, 3612C, RP0900, RT0700C, M3600, M3601	1
164379-4	9,5	7,7	11,5	RP1800FX, RP2300FCX, 3612, 3612C, RP0900, RT0700C, M3600, M3601	1
164388-3	12	10	9	RP1800FX, RP2300FCX, 3612, 3612C, RP0900, RT0700C, M3600, M3601	1
164393-0	20	18	13	RP1800FX, RP2300FCX, 3612, 3612C, RP0900, RT0700C, M3600, M3601	1
164470-8	27	24	13	RP1800FX, RP2300FCX, 3612, 3612C, RP0900, RT0700C, M3600, M3601	1
164471-6	30	27	13	RP1800FX, RP2300FCX, 3612, 3612C, RP0900, RT0700C, M3600, M3601	1
164775-6	11	9	13	RP1800FX, RP2300FCX, 3612, 3612C, RP0900, RT0700C, M3600, M3601	1
164776-4	12,7	11	13	RP1800FX, RP2300FCX, 3612, 3612C, RP0900, RT0700C, M3600, M3601	1
165046-4	40	37	13	RP1800FX, RP2300FCX, 3612, 3612C, RP0900, RT0700C, M3600, M3601	1
344364-5	16	14,5	13	RP1800FX, RP2300FCX, 3612, 3612C, RP0900, RT0700C, M3600, M3601	1

Suporturi și baze pentru freze și mașini de frezat



	Cod	Descriere	Pentru modelul	Ambalare (buc./set)
	122256-6	Suport opritor lateral	3612, 3612C	1
	122703-7	Ghid pentru freze cu rulmenți	3709, 3710, RT0700C, DRT50	1
	122704-5	Ghid direct	3709	1
	122745-1	Ghid direct	3710	1
	123022-4	Ghid pentru freze cu rulment	3612, 3612C, RP1800F, RP1801, RP2300F, RP2301	1
	123544-4	Bază de tăiere	3707, 3708	1

	Cod	Descriere	Pentru modelul	Ambalare (buc./set)
	164834-6	Ghid direct	3620, RP0910, RP1110C, RP0900	1
	193448-4	Ghidaj circular, 100-340 mm	3706, DCO180	1
	193904-4	Bază de tăiere	3707, 3708	1
	194579-2	Adaptor de ghidare 1.400 / 3.000 mm	3612, 3612C, RP0900, RP0910, RP1110C, RP1800FC, RP1801, RP2300FCX, RP2301, RT0700C	1
	195136-9	Ansamblu ghidaj liniar	RP1800FX, RP1801, RP2300FCX, RP0900, RP0910, RP1110C, RT0700C	1
	195562-2	Bază de frezare colțuri	RT0700C	1
	195563-0	Ansamblu bază plonjare	RT0700C	1
	198987-9	Bază de basculare	RT0700C	1
	196613-4	Bază pentru margini	DRT50, RT001, RT0702, RT0700	1
	199089-4	Bază transparentă	DRT50	1
	342428-9	Ghid direct	3612, 3612C	1
	STEX122385	Ghid pentru freze cu rulmenți	3620, RP0900	1

ACCESORII PENTRU MAȘINI DE FREZAT LAMELARE
Disc cu dinți TCT

	Cod	Alezaj (mm)	Diametru (mm)	Număr dinți	Grosimea tăierii (mm)	Turație maximă (min ⁻¹)	Pentru modelul	Ambalare (buc./set)
	B-20644	22	100	6	4,0	12.090	3901, DPJ180,	1

Suporturi

	Cod	Descriere	Pentru modelul	Ambalare (buc./set)
	122473-8	Ghidaj unghiular	3901	1
	123149-0	Ghidaj unghiular	PJ7000, DPJ180	1
	415579-2	Placă distanțieră	3901, PJ7000, DPJ180	1

ACCESORII PENTRU MAȘINA DE FĂCUT CANELURI ȘI DEBITAT ÎN ALUMINIU COMPOZIT CA5000
Discuri cu dinți TCT pentru caneluri

Lame fierăstrău pentru tăierea canelurilor în panouri compozite din aluminiu.











Cod	Diametru (mm)	Alezaj (mm)	Număr dinți	Unghi de tăiere (°)	Unghi (A) (°)	Turație maximă (min ⁻¹)	Pentru aluminiu	Pentru modelul	Ambalare (buc./set)
B-48832	118	20	6	90	90	12.940	•	CA5000	1
B-48860	118	20	6	135	45	12.940	•	CA5000	1

Alte accesorii







	Cod	Descriere	Ambalare (buc./set)
	143396-7	Placă de schimb completă CA5000	1

ACCESORII PENTRU RINDELUIRE

Cuțite de rindeluit

	Cod	Descriere	Lățime (mm)	Pentru modelul	Ambalare (buc./set)
	A-86175	Placă montare cuțite rindea	82	1902, N1923B, 1923H, KP0810, KP0810C, KP0800, DKP180, KP181	1
	D-07945	Set cuțite rindea	82	1100/N, N1900B, 1902, N1923B/H, KP0810/C, KP0800, DKP180, KP181	2/1
	D-07951	Set cuțite reversibile HM	82	1100/N, N1900B, 1902, N1923B/H, KP0810/C, KP0800, DKP180, KP181	4/1
	D-07967	Set cuțite rindea HM	82	1100/N, N1900B, 1902, N1923B/H, KP0810/C, KP0800, DKP180, KP181	2/1
	D-16346	Set cuțite rindea HSS	82	1100, 1902, N1923H, KP0800, KP0810, DKP180, DKP181	2/1
	D-08822	Set cuțite rindea HM	110	1911B	2/1
	D-70910	Set cuțite rindea HSS	155	1805B	2/1
	D-63666	Set cuțite de rindea HSS	170	1806B	2/1
	199911-5	Set cuțite de rindea HSS	306	2012NB	2/1
	793346-8	Set cuțite de rindea HSS	306	2012NB	2/1
	B-02870	Set cuțite de rindea HSS	312	KP312S	2/1

Alte accesorii

	Cod	Descriere	Pentru modelul	Ambalare (buc./set)
	122785-9	Ghidaj paralel	KP0810, KP0810C	1
	122791-4	Ghidaj șanfrenare	KP0810, KP0810C	1
	123004-6	Suport ascuțire lame 82 mm	1902, N1923B, 1923H, KP0810, KP0810C, KP0800, DKP180	1
	123006-2	Suport ascuțire lame 155 mm	1806B	1
	123055-9	Suport ascuțire lame 110 mm	1911B	1
	123062-2	Șablon de reglare a lamei de 82 mm	1902, 1911B, N1923, 1923H, KP0810, KP0810C, KP0800, DKP181	1
	164371-0	Ghidaj paralel	1902, 1911B	1
	165259-7	Ghidaj paralel	N1923B, 1923H	1
	191C22-0	Set șanfrenare	DKP181	2/1
	191C23-8	Ghidaj paralel	DKP181, KP0810/C	1
	195055-9	Ghidaj paralel	1923B, DKP180, KP0800	1
	342390-8	Ghidaj limitator adâncime	DKP181, KP0810/C, N1923B	1
	762016-0	Șablon calibrare lame	2012NB	1

ACCESORII PENTRU MAȘINI MULTIFUNCȚIONALE

Prindere tip scai



STARLOCK

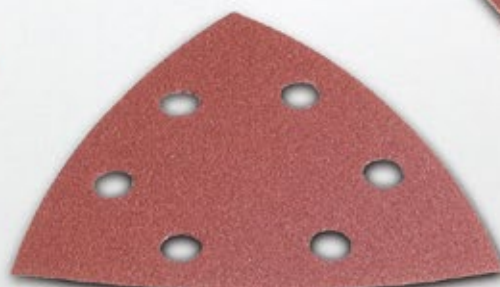

STARLOCK



Diverse materiale Lemn Tencuială Metal Lemn și metal



★★ Recomandat ★ Acceptabil - Fără evaluare

	Dimensiune (mm)	Nr. dinți	Materiial lamă	Lemn	Plecaje	PAL	Panouri gips carton	Metale neferoase	Tablă	Inox	Cue moi	Epoxy, fibră de sticlă	Linoleum, covoare	Adeziv covoare	Izolații	Sigilii	Beton poros, cărămidă	Placi ceramice moi	Mortar, adeziv gresie
--	-----------------	-----------	----------------	------	---------	-----	---------------------	------------------	-------	------	---------	------------------------	-------------------	----------------	----------	---------	-----------------------	--------------------	-----------------------

TĂIERE

TMA045	85	18	Bim	★★	★★	★★	★	★★	★	-	★★	★	-	-	-	-	-	-	-
TMA046	100	15	Bim	★★	★★	★★	★	★	-	-	-	★	-	-	-	-	-	-	-
TMA049	85	18	HCS	★	★	-	-	-	-	-	-	-	-	-	-	-	-	-	-
TMA064	85	18	Bim	★★	★★	★★	★★	★★	★	-	★★	★★	-	-	-	-	-	-	-

TĂIERE LA CALD

TMA047	32	20	Bim	★★	★★	★★	★	★	★★	-	★★	★	-	-	-	-	-	-	-
TMA048	65	20	Bim	★★	★★	★★	★★	★	★	-	★★	★	-	-	-	-	-	-	-
TMA050	24	18	HCS	★	★	★	-	-	-	-	-	-	-	-	-	-	-	-	-
TMA051	32	18	HCS	★	★	★	-	-	-	-	-	-	-	-	-	-	-	-	-
TMA052	65	20	HCS	★	★	★	-	-	-	-	-	-	-	-	-	-	-	-	-
TMA053	32	14	Bim	★★	★★	★★	★	-	-	-	-	★	-	-	-	-	-	-	-
TMA054	32	14	HCS	★	★	-	-	-	-	-	-	-	-	-	-	-	-	-	-
TMA055	65	14	Bim	★★	★★	★★	★	-	-	-	-	★	-	-	-	-	-	-	-
TMA056	65	14	HCS	★	★	-	-	-	-	-	-	-	-	-	-	-	-	-	-
TMA057	10	20	Bim	★★	★★	★★	★★	★★	★★	-	★★	★	-	-	-	-	-	-	-
TMA058	20	20	Bim	★★	★★	★★	★★	★★	★★	-	★★	★	-	-	-	-	-	-	-
TMA059	32	20	Bim	★	★	★	★★	★★	★★	-	★★	★	-	-	-	-	-	-	-
TMA060	20	23	TC	★	★	★	★★	★★	★★	-	★★	★★	-	-	-	-	★★	-	-
TMA061	32	23	TC	★	★	★	★★	★★	★★	★★	★★	★★	-	-	-	-	★★	-	-
TMA079	45	23	TC	★	★	★	★★	★★	★	★	★	★	-	-	-	-	-	-	-
TMA080	32	20	TC	★	★	★	★★	★★	★	★	★	★	-	-	-	-	-	-	-
TMA081	53	14	Bim	-	★	★★	★★	-	-	-	★	-	-	-	-	-	-	-	-

RĂZUIRE

TMA065	52	-	HCS	-	-	-	-	-	-	-	-	-	-	★★	-	-	-	-	★
TMA066	52	-	HCS	-	-	-	-	-	-	-	-	-	-	★★	-	-	-	-	-

TĂIERE

TMA063	100	-	Bim	-	-	-	-	-	-	-	-	-	★★	-	★★	-	-	-	-
TMA067	28	-	HCS	-	-	-	-	-	-	-	-	-	-	-	-	★★	-	-	-
TMA082	12	-	Nerjavno	-	-	-	-	-	-	-	-	-	-	-	-	★★	-	-	-
TMA068	11	-	HCS	-	-	-	-	-	-	-	-	-	★★	-	★★	-	-	-	-
TMA070	85	-	Diamantno	-	-	-	★	-	-	-	-	★★	-	-	-	★★	-	★★	-

CURĂȚARE

TMA074	70	-	TC #40	-	-	-	★	-	-	-	-	★★	-	★	-	-	-	-	★★
--------	----	---	--------	---	---	---	---	---	---	---	---	----	---	---	---	---	---	---	----

FREZARE

TMA071	70	-	TC #50	-	-	-	★	-	-	-	-	★★	-	-	-	-	★★	★	-
TMA074	70	-	TC #40	-	-	-	-	-	-	-	-	-	-	-	-	★★	-	★★	-
TMA075	32	-	TC #50	-	-	-	-	-	-	-	-	★★	-	-	-	-	★★	★	★★

POLIZARE

TMA073	78	-	TC #20	-	-	-	-	-	-	-	-	-	-	-	-	-	-	-	★★
TMA083	90	-	TC #20	★	★	★	-	-	-	-	-	-	-	-	-	-	-	-	★★
TMA084	90	-	TC #40	★	★	★	-	-	-	-	-	-	-	-	-	-	-	-	★★
TMA085	90	-	TC #60	★★	★★	★★	-	-	-	-	-	-	-	-	-	-	-	-	-
TMA086	90	-	TC #100	★★	★★	★★	-	-	-	-	-	-	-	-	-	-	-	-	-

ACCESORII STARLOCK











Pânze

Pânze de tăiere și prelucrare a lemnului, metalului, plasticului și alte materiale de construcții.



























	Cod	Descriere	Cod Makita	Dimensiune (mm)	Pentru modelul	Potrivit pentru	Ambalare (buc./set)
	B-64799	Pânză segmentată BiM	TMA045	85	DTM50, DTM51, TM3000C, TM3010C	lemn și metale neferoase	1
	B-64808	Pânză segmentată BiM	TMA046	100	DTM50, DTM51, TM3000C, TM3010C	plastic	1
	B-64814	Pânză cu intrare directă BiM	TMA047	32x50	DTM50, DTM51, TM3000C, TM3010C	lemn și metale neferoase	1
	B-64814-5	Pânză cu intrare directă BiM	TMA047	32x50	DTM50, DTM51, TM3000C, TM3010C	lemn și metale neferoase	5/1
	B-64820	Pânză cu intrare directă BiM	TMA048	65x40	DTM50, DTM51, TM3000C, TM3010C	lemn și metale neferoase	1
	B-64836	Pânză segmentată HCS	TMA049	85	DTM50, DTM51, TM3000C, TM3010C	lemn	1
	B-64842	Pânză cu intrare directă HCS	TMA050	24x50	DTM50, DTM51, TM3000C, TM3010C	lemn	1
	B-64858	Pânză cu intrare directă HCS	TMA051	32x50	DTM50, DTM51, TM3000C, TM3010C	lemn	1
	B-64858-5	Pânză cu intrare directă HCS	TMA051	32x50	DTM50, DTM51, TM3000C, TM3010C	lemn	5/1
	B-64864	Pânză cu intrare directă HCS	TMA052	65x40	DTM50, DTM51, TM3000C, TM3010C	lemn și produse din lemn	1





	Cod	Descriere	Cod Makita	Dimensiune (mm)	Pentru modelul	Potrivit pentru	Ambalare (buc./set)
	B-64870	Pânză cu intrare directă BiM	TMA053	32x50	DTM50, DTM51, TM3000C, TM3010C	lemn de esență tare	1
	B-64886	Pânză cu intrare directă HCS	TMA054	320x50	DTM50, DTM51, TM3000C, TM3010C	prelucrarea lemnului	1
	B-64892	Pânză cu intrare directă BiM	TMA055	65x40	DTM50, DTM51, TM3000C, TM3010C	lemn esență tare și plăci laminate	1
	B-64901	Pânză cu intrare directă HCS	TMA056	65x40	DTM50, DTM51, TM3000C, TM3010C	oțel, inox, aluminiu, fontă, metale cu rezistență <800 N / mm ²	1
	B-64917	Pânză cu intrare directă BiM	TMA057	10x30	DTM50, DTM51, TM3000C, TM3010C	metale și plăci rigips	1
	B-64923	Pânză cu intrare directă BiM	TMA058	20x30	DTM50, DTM51, TM3000C, TM3010C	metale și cupru	1
	B-64939	Pânză cu intrare directă BiM	TMA059	32x50	DTM50, DTM51, TM3000C, TM3010C	metale și cupru	1
	B-64945	Pânză cu intrare directă HM	TMA060	20x40	DTM50, DTM51, TM3000C, TM3010C	șuruburi, oțel și materiale abrazive	1
	B-64951	Pânză cu intrare directă HM	TMA061	32x40	DTM50, DTM51, TM3000C, TM3010C	șuruburi, oțel și materiale abrazive	1
	B-64967	Pânză segmentată circulară BiM	TMA063	100	DTM50, DTM51, TM3000C, TM3010C	linoleu, covoare și cauciuc	1
	B-64973	Pânză segmentată circulară BiM-TiN	TMA064	85	DTM50, DTM51, TM3000C, TM3010C	metale neferoase, fibră de sticlă, PVC	1
	B-64989	Răzuitor HCS	TMA065	52x26	DTM50, DTM51, TM3000C, TM3010C	adezivi, materiale pentru rosturi	1

	Cod	Descriere	Cod Makita	Dimensiune (mm)	Pentru modelul	Potrivit pentru	Ambalare (buc./set)
	B-64995	Răzuitor flexibil HCS	TMA066	52x26	DTM50, DTM51, TM3000C, TM3010C	adezivi, silicon	1
	B-65006	Pânză pentru rosturi HCS	TMA067	28x40	DTM50, DTM51, TM3000C, TM3010C	rosturi, silicon	1
	B-65012	Cuțit universal HCS	TMA068	11x24	DTM50, DTM51, TM3000C, TM3010C	diverse materiale	1
	B-65028	Pânză segmentată circulară HM-RIFF	TMA067	85	DTM50, DTM51, TM3000C, TM3010C	rosturi	1
	B-65034	Pânză segmentată circulară diamantată	TMA070	85	DTM50, DTM51, TM3000C, TM3010C	rosturi, plăci ceramice	1
	B-65040	Pânză segmentată circulară HM-RIFF	TMA071	70	DTM50, DTM51, TM3000C, TM3010C	rosturi, plăci ceramice	1
	B-65062	Pânză TCT HM-RIFF	TMA073	78	DTM50, DTM51, TM3000C, TM3010C	adezivi pentru plăci ceramice	1
	B-65078	Disc îndepărtarea mortarului HM	TMA074	70	DTM50, DTM51, TM3000C, TM3010C	chituri, rosturi și mortar	1
	B-65084	Pânză cu intrare directă HM	TMA075	32x30	DTM50, DTM51, TM3000C, TM3010C	fibră de sticlă	1
	B-69814	Pânză șlefuire HM-RIFF	TMA085	90	DTM50, DTM51, TM3000C, TM3010C	suprafețe de lemn	1

Hârtie abrazivă





	Cod	Granulație	Număr găuri	Dimensiuni (L x l x H) (mm)	Pentru modelul	Pridere cu arici	Ambalare (buc./set)
 	B-21559	60, 80, 100, 120, 180	6	94 x 94 x 94	DTM50, DTM51, TM3000C, TM3010C	•	10/1
	B-21618	60, 80, 120, 180, 240	6	94 x 94 x 94	DTM50, DTM51, TM3000C, TM3010C	•	10/1
	B-21674	60, 80, 100, 240, 320	6	94 x 94 x 94	DTM50, DTM51, TM3000C, TM3010C	•	10/1
	B-21733	120, 240, 400, 600, 1.200	6	94 x 94 x 94	DTM50, DTM51, TM3000C, TM3010C	•	10/1
	B-21814	/	/	94 x 94 x 94	DTM50, DTM51, TM3000C, TM3010C		1
	B-21783	1.200	6	94 x 94 x 94	DTM50, DTM51, TM3000C, TM3010C	•	10/1
 	B-21565	60	6	94 x 94 x 94	DTM50, DTM51, TM3000C, TM3010C	•	10/1
	B-21624	60	6	94 x 94 x 94	DTM50, DTM51, TM3000C, TM3010C	•	10/1
	B-21680	60	6	94 x 94 x 94	DTM50, DTM51, TM3000C, TM3010C	•	10/1
	B-21630	80	6	94 x 94 x 94	DTM50, DTM51, TM3000C, TM3010C	•	10/1
	B-21696	80	6	94 x 94 x 94	DTM50, DTM51, TM3000C, TM3010C	•	10/1

	Cod	Granulație	Număr găuri	Dimensiuni (L x l x H) (mm)	Pentru modelul	Pridere cu arici	Ambalare (buc./set)
	B-21587	100	6	94 x 94 x 94	DTM50, DTM51, TM3000C, TM3010C	•	10/1
	B-21705	100	6	94 x 94 x 94	DTM50, DTM51, TM3000C, TM3010C	•	10/1
	B-21808	100	/	94 x 94 x 94	DTM50, DTM51, TM3000C, TM3010C		1
	B-22947	100	6	94 x 94 x 94	DTM50, DTM51, TM3000C, TM3010C	•	10/1
	B-21646	120	6	94 x 94 x 94	DTM50, DTM51, TM3000C, TM3010C	•	10/1
	B-21749	120	6	94 x 94 x 94	DTM50, DTM51, TM3000C, TM3010C	•	10/1
	B-22969	120	6	94 x 94 x 94	DTM50, DTM51, TM3000C, TM3010C	•	10/1
	B-22953	150	6	94 x 94 x 94	DTM50, DTM51, TM3000C, TM3010C	•	10/1
 LONG LIFE	B-21602	180	6	94 x 94 x 94	DTM50, DTM51, TM3000C, TM3010C	•	10/1
	B-21652	180	6	94 x 94 x 94	DTM50, DTM51, TM3000C, TM3010C	•	10/1
	B-21668	240	6	94 x 94 x 94	DTM50, DTM51, TM3000C, TM3010C	•	10/1
	B-21711	240	6	94 x 94 x 94	DTM50, DTM51, TM3000C, TM3010C	•	10/1

	Cod	Granulație	Număr găuri	Dimensiuni (L x l x H) (mm)	Pentru modelul	Pridere cu arici	Ambalare (buc./set)
	B-21755	240	6	94 x 94 x 94	DTM50, DTM51, TM3000C, TM3010C	•	10/1
	B-21727	320	6	94 x 94 x 94	DTM50, DTM51, TM3000C, TM3010C	•	10/1
	B-21761	400	6	94 x 94 x 94	DTM50, DTM51, TM3000C, TM3010C	•	10/1
	B-21777	600	6	94 x 94 x 94	DTM50, DTM51, TM3000C, TM3010C	•	10/1

Seturi



	Cod	Descriere	Pentru modelul	Setul conține	Ambalare (buc./set)
	B-67480	Set pânze cu intrare directă	DTM50, DTM51, TM3000C, TM3010C	B-64799, B-64814, B-64870, B-64923	1
	B-67496	Set pânze ceramice	DTM50, DTM51, TM3000C, TM3010C	B-64923, B-64989, B-65028, B-65062	1
	B-67505	Set pânze pentru podea	DTM50, DTM51, TM3000C, TM3010C	B-64799, B-64820, B-64858, B-64995	1
	B-67511	Set pânze pentru dulgherit	DTM50, DTM51, TM3000C, TM3010C	B-64799, B-64814, B-64870, B-65115	1

ACCESORII PENTRU DEBITARE

- Metal 
- Aluminiu 
- Oțel inoxidabil 
- Fibră de sticlă 
- Lemn cu cuie 
- Lemn 
- Panouri sandwich 
- Corian 
- Plăci laminate 
- Zidărie 
- Plastic, PVC 
- Gheață 
- Tăiere fină, netedă 
- Tăiere grosieră 
- Tăiere longitudinală 
- Tăiere transversală 
- Tăiere rapidă 
- Prindere tip T 
- Prindere Makita 
- Fierăstraie circulare de masă 
- Fierăstraie circulare cu banc 
- Fierăstraie circulare de mână 
- Fierăstraie circulare de mână cu acumulatori 
- Fierăstraie alternative cu acumulatori 
- Fierăstraie circulare de masă cu acumulatori 



DISCURI TCT PENTRU FIERĂSTRĂIE CIRCULARĂ

Linia profesională pentru toate tipurile de fierăstrăie circulare

Discurile de fierăstrău Makita sunt realizate din oțel de înaltă calitate și dispun de un înalt grad de durabilitate. Fiecare dinte este ascuțit cu precizie și facilitează tăieri curate și netede.



MForce

Lamă cu design revoluționar al dinților. Tăierea materialului cu dinți mai puțini asigură proces de lucru rapid și tăieturi curate și netede.



Makblade

Linia de discuri Makblade a fost concepută pentru fierăstraie circulare electrice și cu acumulatori. Au fost dezvoltate pentru a efectua tăieturi netede și au o durată de viață extinsă.



Makforce

Linia Makforce oferă o gamă largă de discuri de calitate pentru fierăstraie portabile. Vârful din carbură al dinților le conferă o durată de viață extinsă.



Specialized

Linie dezvoltată pentru echipamente specific, materiale și aplicații speciale. Modul de dispunere al dinților permite tăierea unei game largi de materiale de construcție, cum ar fi: cuie, lemn noduros, aluminiu, oțel, panouri compozit. Potrivite pentru fierăstraie cu acumulatori.



Makblade Plus

Absorb vibrațiile și asigură funcționarea netedă și uniformă a discului. Discuri de calitate premium destinate pentru fierăstraie circulare fixe și fierăstraie unghiulare.



Efficut

Forma nouă crește eficiența în îndepărtarea deșeurilor, permite o tăiere de 2,5 ori mai rapidă și crește durata de lucru cu o singură încărcare. Recomandate pentru fierăstraie cu acumulatori și fierăstraie unghiulare fixe.

EXPLICAȚIILE CODURILOR ID MAKITA

TIPUL TĂIETURII	DIAMETRU Ø	DIAMETRU INTERIOR Ø
C = Grosieră	mm	A = 10 mm B = 15 mm
M = Medie		C = 15,88 mm D = 16 mm
F = Fină		E = 20 mm F = 25,4 mm
XF = Foarte fină		G = 30 mm

TIPURI DE DISCURI	DISCURI SPECIALIZATE	NUMĂR DINȚI	POSEBNOSTI
MS = Fierăstrău fix și unghiular	X = MForce		L = Tehnologie laser pentru tăiere silențioasă
CS = Fierăstrău circular manual	E = Lame strânse		
TS = Fierăstrău circular fix	A = Aluminiu		
BSS = DSS610 Fierăstrău circular manual			
CMS = Fierăstrău fix și unghiular cu acumulator			
CC = Fierăstrău circular manual cu acumulator			
CSP = Fierăstrău subsmersibil			
MCS = Fierăstrău circular pentru metal			

CSCX23024GL

DISCURI PENTRU FIERĂSTRAIE CIRCULARE

FORMA DINȚILOR

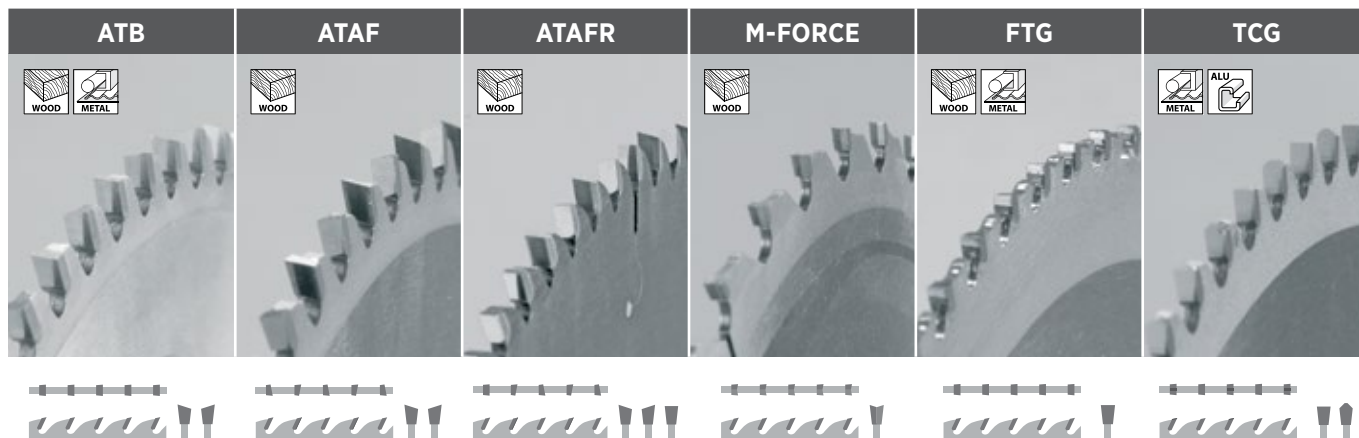

Partea superioară cu unghi de înclinare a dinților.

Partea superioară și laterală cu unghi de înclinare a dinților.

Partea superioară și laterală cu unghi de înclinare a dinților intercalat cu câte un dinte drept.

Dinți în formă de M, cu muchii de tăiere multiple care asigură tăieturi foarte curate.

Partea superioară a dinților este dreaptă.

Dinți alternați trapezoidal și drepiți.

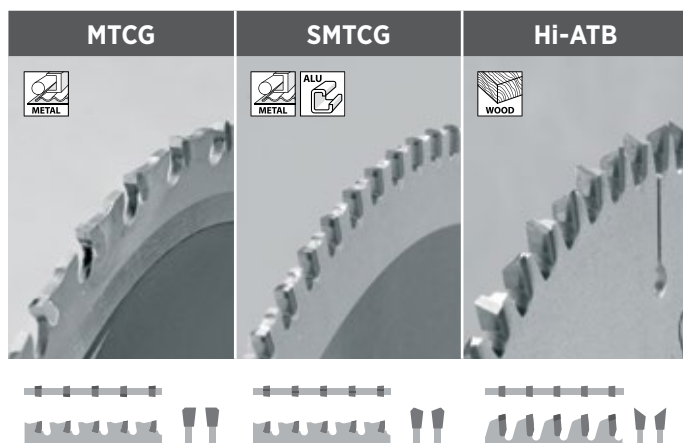

Dispunere alternativă de dinți drepiți cu vârful tăiat pe o parte sau pe cealaltă.

Dispunere alternativă, parte stângă parte dreaptă a dinților trapezoidal mai lungi.

Partea superioară cu unghi de înclinare a dinților cu înclinare superioară mai mare.

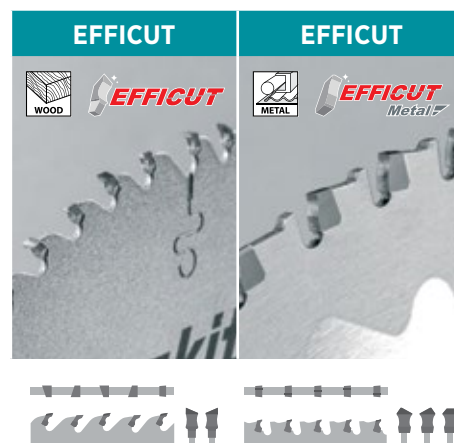

Forma specială a vârfului face posibilă tăierea rapidă și fină, și asigură un volum de lucru mai mare cu o singură încărcare a acumulatorului.

TEHNOLOGIE

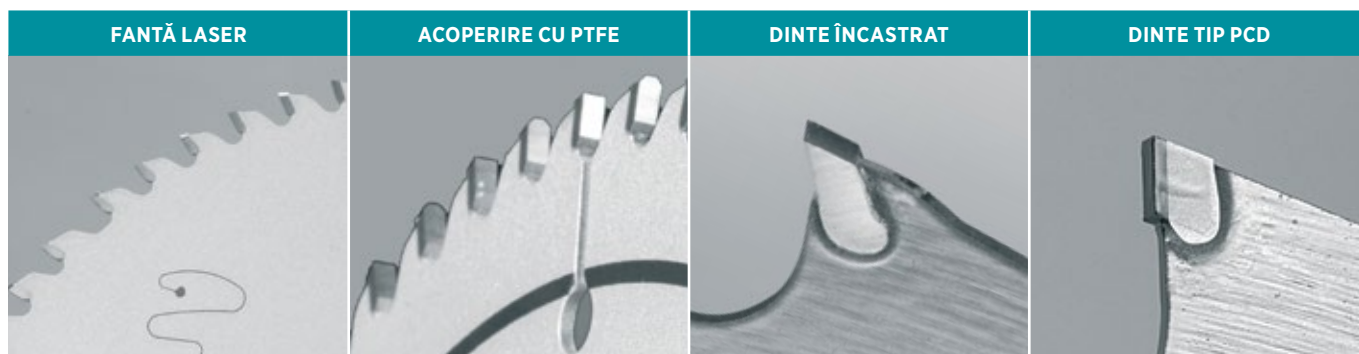

Sistem de absorbție a vibrațiilor. Fante executate cu laser pentru tăieri fine și silențioase.

Acoperirea cu PTFE (politetrafluoretilenă) reduce rezistența discului la forța de frecare.

Dintele de tip încadrat crește capacitatea de prindere și conferă un randament ridicat.

PCD (Poly-Crystalline Diamond). Dinte de duritate extremă și rezistent la uzură. Cea mai bună alegere pentru tăieri de lungă durată, mai ales în fibrociment.











EFFICUT

DISCURI EFFICUT PENTRU LEMN



FORMA

			<p>PARTEA SUPERIOARĂ A DINTELUI ASCUȚITĂ Asigură o tăiere fină și rezistență la frecare redusă.</p>
			<p>PARTEA MEDIANĂ CURBATĂ Eficacitate crescută în îndepărtarea deșeurilor.</p>
			<p>PARTEA INFERIOARĂ ÎNGUSTĂ Forma îngustă reduce rezistența la frecare și extinde durata acumulatorului.</p>

MAI MULTE TĂIERI



TĂIERE MAI RAPIDĂ



TIMP DE LUCRU EXTINS AL ACUMULATORULUI



MAI MULTE TĂIERI



TĂIERE MAI RAPIDĂ

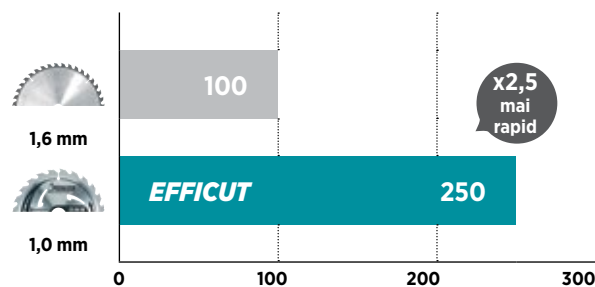

NOTĂ: 1. Rezultatele testelor depind de duritatea lemnului. 2. Valorile din grafic sunt relative când capacitatea de tăiere a discului Makita (grosime: 1,0 mm) este indexată cu 100.



EFFICUT
Metal

DISCURI EFFICUT PENTRU METAL



FORMA



×



▶



PARTEA SUPERIOARĂ A DINTELUI ASCUȚITĂ

Asigură o tăiere fină și rezistență la frecare redusă..



×



▶



PARTEA MEDIANĂ CURBATĂ

Eficacitate crescută în îndepărtarea deșeurilor.

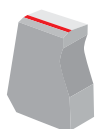

PARTEA INFERIOARĂ ÎNGUSTĂ

Forma îngustă reduce rezistența la frecare și extinde durata acumulatorului.

MAI MULTE TĂIERI

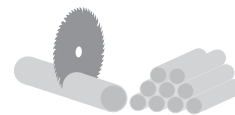

TĂIERE MAI RAPIDĂ



TIMP DE LUCRU EXTINS AL ACUMULATORULUI



MAI MULTE TĂIERI



NOTĂ: Testul a fost efectuat cu fierăstrău cu acumulatori pentru tăiat metale, DCS553, acumulator 18V 6,0Ah. Material: tub din oțel carbon, cu diametru de 31 mm și grosime de 3 mm.



Discuri EFFICUT pentru tăiere lemn



Cod	Cod înlocuitor	Diametru (mm)	Alezaj (mm)	Grosime disc (mm)	Număr dinți	Grosime tăiere (mm)	Unghi tăiere (°)	Turație maximă (min ⁻¹)	Ambalare (buc./set)
B-62979	B-62985	165	20	1,0	25	1,4	23	9.250	1
B-69858	B-69864	165	20	1,35	60	1,85	10	9.250	1
B-64185	B-64191	190	30	1,0	24	1,45	23	8.040	1
E-08888	E-08903	216	30	1,5	60	1,5	10	7.070	1
B-64624	B-64630	260	30	1,65	45	2,15	10	5.870	1
B-67234	B-67284	260	30	1,65	60	2,15	10	5.870	1
B-67240	B-67290	260	30	1,65	80	2,15	10	5.870	1
E-12930	E-12946	270	30	1,5	24	2,15	23	5.650	1
B-67256	B-67309	305	30	1,65	60	2,15	10	5.000	1
B-67262	B-67315	305	30	1,65	80	2,15	10	5.000	1
B-67278	B-67321	305	30	1,65	100	2,15	10	5.000	1
E-24848	-	415	30	1,8	35	2,6	23	3680	1



Discuri EFFICUT pentru tăiere lemn



Cod	Cod înlocuitor	Diametru (mm)	Alezaj (mm)	Grosime disc (mm)	Număr dinți	Grosime tăiere (mm)	Unghi tăiere (°)	Turație maximă (min ⁻¹)	Ambalare (buc./set)
E-11140	E-11178	190	20	1,35	25	1,85	10	8.040	1
E-11156	E-11184	190	20	1,35	45	1,85	10	8040	1
B-68622	B-68638	190	30	1	45	23	8.04	1.450	1
E-11162	E-11190	190	20	1,35	60	1,85	10	8.040	1
E-06971	E-06987	216	30	1,5	45	2	10	7.070	1
E-01909	E-01915	235	30	1,5	24	20	6.5	2,200	1
E-07696	E-07705	260	60	1,5	24	2,15	23	5.870	1



Discuri EFFICUT pentru tăiere materiale compozite și lemn

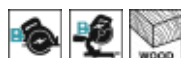

Cod	Cod înlocuitor	Diametru (mm)	Alezaj (mm)	Grosime disc (mm)	Număr dinți	Grosime tăiere (mm)	Unghi tăiere (°)	Geometrie	Ambalare (buc./set)
E-12158	E-12223	165	30	1	40	1,5	15	ATAFR	1
E-12170	E-12245	185	30	1	40	1,5	15	ATAFR	1
E-12186	E-12251	190	20	1,35	50	1,85	8	ATAFR	1
E-12192	E-12267	216	30	1,5	60	2	8	ATAFR	1

Cod	Cod înlocuitor	Diametru (mm)	Alezaj (mm)	Grosime disc (mm)	Număr dinți	Grosime tăiere (mm)	Unghi tăiere (°)	Geometrie	Ambalare (buc./set)
E-12201	E-12273	260	30	1,65	75	2,15	8	ATAFR	1

Discuri EFFICUT pentru tăiere lemn, MDF



Cod	Cod înlocuitor	Diametru (mm)	Alezaj (mm)	Grosime disc (mm)	Număr dinți	Grosime tăiere (mm)	Unghi tăiere (°)	Turație maximă (min ⁻¹)	Ambalare (buc./set)
B-57320	B-57336	165	20	1	56	1,45	23	9.250	1

Discuri EFFICUT pentru tăiere metal



Cod	Cod înlocuitor	Diametru (mm)	Alezaj (mm)	Grosime disc (mm)	Număr dinți	Grosime tăiere (mm)	Unghi tăiere (°)	Turație maximă (min ⁻¹)	Ambalare (buc./set)
B-69266	B-69303	136	20	0,95	30	1,1	0	4.500	1
B-69288	B-69325	150	20	0,95	33	1,1	0	4.680	1
E-12859	-	185	30	1,4	45	1,6	0	/	1
E-12049	E-12055	305	25,4	1,75	63	2	-2	/	1

Discuri EFFICUT pentru tăiere metal și inox

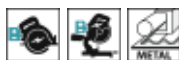

Cod	Cod înlocuitor	Diametru (mm)	Alezaj (mm)	Grosime disc (mm)	Număr dinți	Grosime tăiere (mm)	Unghi tăiere (°)	Turație maximă (min ⁻¹)	Ambalare (buc./set)
B-69272	B-69319	136	20	0,95	45	1,1	0	4.500	1
B-69294	B-69331	150	20	0,95	48	1,1	0	4.680	1
E-12843	E-12865	185	30	1,2	60	1,4	0	/	1



Discuri EFFICUT pentru tăiere aluminiu



Cod	Cod înlocuitor	Diametru (mm)	Alezaj (mm)	Grosime disc (mm)	Număr dinți	Grosime tăiere (mm)	Unghi tăiere (°)	Turație maximă (min ⁻¹)	Ambalare (buc./set)
E-13306	E-13312	305	30	2	96	2.8	-3	5.000	1

Discuri specializate pentru tăiere lemn

Discurile premium sunt special concepute pentru fierăstraiele cu acumulatori. Discurile sunt proiectate pentru tăierea lemnului și se potrivesc tuturor fierăstraielelor cu acumulatori, sunt construite din oțel și sunt extrem de subțiri și bine echilibrate. Dinții sunt proiectați pentru tăieturi universale în lemn. Discurile HM sunt precise și bine ascuțite și permit realizarea ușoară a tăieturilor netede și oferă o durată de viață mai mare. Discul B-09248 este realizat pentru poziția din stînga a fierăstrăului. Potrivit pentru DHS680 și DSS610.



Cod	Cod înlocuitor	Diametru (mm)	Alezaj (mm)	Grosime disc (mm)	Număr dinți	Grosime tăiere (mm)	Unghi tăiere (°)	Turație maximă (min ⁻¹)	Ambalare (buc./set)
B-14607	-	85	20	0,7	20	1,0	10	2.240	1
B-16885	B-33576	85	15	0,7	20	1,0	10	2.240	1
B-10643	B-33532	136	20	1,0	16	1,5	20	4.500	1
B-09151	-	160	20	1,0	24	1,5	20	4.77	1
B-09173	B-32910	165	20	1,0	24	1,5	20	6.500	1
B-09232	B-32954	165	20	1,0	40	1,6	18	6.500	1
B-09248	B-32960	165	20	1,0	40	1,6	18	6.500	1
B-53207	B-53229	165	20	1,0	44	1,45	23	6.500	1
B-09195	B-32926	190	30	1,4	24	2,0	20	3.000	1
B-09254	B-32976	190	30	1,4	40	2,0	10	3.000	1

Discuri specializate pentru tăiere prin plonjare

Discurile sunt special concepute pentru fierăstraie cu tăiere prin plonjare. Aceste discuri au specificații similare cu discurile premium MAKBlade Plus cu o tehnologie patentată de amortizare a vibrațiilor. Discurile de fierăstrău cu mai puține vibrații sunt mai precise deoarece se mișcă mai puțin. Sistemul de amortizare a vibrațiilor constă dintr-o rășină sintetică aplicată pe o creștătură tăiată cu laser. Designul special al bazei discului permite utilizarea discurilor foarte subțiri și producerea de tăieri precise.



Cod	Cod înlocuitor	Diametru (mm)	Alezaj (mm)	Grosime disc (mm)	Număr dinți	Grosime tăiere (mm)	Unghi tăiere (°)	Turație maximă (min ⁻¹)	Ambalare (buc./set)
B-09298	B-33015	165	20	1,6	48	2,2	8	9.250	1
B-56699	B-56758	165	20	1,4	28	2	15	9.250	1
B-56708	B-56764	165	20	1,25	48	1,85	8	9.250	1

Discuri specializate pentru tăiere lemn, materiale laminate și MDF

Discuri specializate ce permit tăierea silențioasă și precisă a materialelor laminate.



SPECIALIZED

Cod	Cod înlocuitor	Diametru (mm)	Alezaj (mm)	Grosime disc (mm)	Număr dinți	Grosime tăiere (mm)	Unghi tăiere (°)	Turație maximă (min ⁻¹)	Ambalare (buc./set)
B-33819	B-33577	85	15	0,7	24	1	7	2.240	1
B-29446	B-33825	136	20	1,0	48	1,4	10	4.500	1
B-53198	B-53213	165	20	1,0	44	1,45	23	4.770	1

Discuri specializate pentru tăiere lemn cu cuie

Discurile pentru fierăstrău cu dinți întăriți sunt extrem de rezistente și durabile. Sunt potrivite în special pentru tăierea lemnului cu cuie sau noduri. Posibilitate de utilizare la demolarea sau tăierea lemnului uzat.



SPECIALIZED

Cod	Cod înlocuitor	Diametru (mm)	Alezaj (mm)	Grosime disc (mm)	Număr dinți	Grosime tăiere (mm)	Unghi tăiere (°)	Turație maximă (min ⁻¹)	Ambalare (buc./set)
B-09391	B-33093	165	20	1,25	24	2	23	9.250	1
B-09472	B-33168	165	20	1,3	40	2	18	9.250	1
B-09341	B-33043	185	30	1,25	16	2	25	8.250	1
B-09416	B-33102	185	30	1,3	20	2	25	8.250	1
B-09494	B-33174	185	30	1,3	40	2	25	8.250	1
B-13683	B-33554	190	30	2,6	12	3	20	8.040	1
B-09357	B-33059	190	30	1,3	16	2	23	8.040	1
B-09422	B-33118	190	30	1,3	24	2	23	8.040	1
B-09503	B-33180	190	30	1,3	40	2	23	8.040	1
B-09363	B-33065	210	30	1,4	18	1,9	25	7.300	1
B-09438	B-33124	210	30/25	1,4	24	1,9	23	7.300	1
B-09379	B-33071	235	30	1,6	16	2,3	25	6.500	1
B-13699	B-33560	235	30	2,6	16	3	20	6.500	1
B-09444	B-33130	235	30	1,6	24	2,3	23	6.500	1
B-09519	B-33196	235	30	1,6	48	2,3	18	6.500	1
B-09450	B-33146	270	30	1,8	24	2,6	23	5.650	1
B-09525	B-33205	270	30	1,8	40	2,6	18	5.650	1
B-09531	B-33211	270	30/25	1,8	60	2,6	18	5.650	1
B-09466	B-33152	355	30	2,2	40	3	23	4.300	1
B-09547	B-33227	355	30	2,2	60	3	18	4.300	1

Discuri specializate pentru tăiere metal și inox

Discuri de fierăstrău ce sunt special proiectate pentru tăierea oțelului inoxidabil și au o durată de viață mai îndelungată.



Cod	Cod înlocuitor	Diametru (mm)	Alezaj (mm)	Grosime disc (mm)	Număr dinți	Grosime tăiere (mm)	Unghi tăiere (°)	Turație maximă (min ⁻¹)	Ambalare (buc./set)
B-07870	B-31669	185	30	1,8	40	1,8	-3	5.160	1
B-31669	B-33984	185	30	1,3	64	1,6	0	5.800	1
B-23123	B-33750	305	25,4	1,7	100	2	-3	2.000	1

Discuri specializate pentru tăiere metal

Discuri de fierăstrău dezvoltate pentru tăierea rapidă și precisă a metalelor. Compoziție nouă de carbură metalică combinată cu un design unic al dinților oferă o rezistență excepțională la impact. Comparat cu discurile convenționale sunt de până la 30 de ori mai rezistente.



Cod	Cod înlocuitor	Diametru (mm)	Alezaj (mm)	Grosime disc (mm)	Număr dinți	Grosime tăiere (mm)	Unghi tăiere (°)	Turație maximă (min ⁻¹)	Ambalare (buc./set)
B-10615	B-33526	136	20	1,2	30	1,5	0	4.500	1
B-21973	B-33641	136	20	1,1	50	1,4	-15	4.500	1
B-46296	B-47151	150	20	1,2	32	1,5	0	4.680	1
B-09743	B-33417	185	30	1,5	36	1,9	0	5.800	1
B-09759	B-33423	185	30	1,3	38	2	0	5.800	1
B-09771	B-33445	185	30	1,3	70	1,7	-10	5.800	1
E-23357	-	185	30	1,1	60	1,25	-7	5.800	1
B-09787	B-33451	185	30	1,6	48	2	0	5.800	1
B-23329	B-33722	185	30	1,5	48	1,85	0	5.800	1
B-23363	B-33738	185	30	1,5	56	1,8	0	5.800	1
B-09765	B-33439	305	25,4	1,7	60	2,1	0	2.000	1
B-09793	B-33467	305	25,4	2,3	78	2,3	-5	2.000	1

Discuri specializate pentru tăiere aluminiu

Discuri specializate pentru tăierea aluminiului, plumbului, alamei, bronzului sau alte materiale neferoase. Dinții sunt potriviți pentru tăierea plasticului sau materialelor laminare. Aplicați ceară pe dinți pentru a proteja discul. Discuri foarte subțiri și bine echilibrate ce permit o tăiere precisă.



Cod	Cod înlocuitor	Diametru (mm)	Alezaj (mm)	Grosime disc (mm)	Număr dinți	Grosime tăiere (mm)	Unghi tăiere (°)	Turație maximă (min ⁻¹)	Ambalare (buc./set)
B-09553	B-33233	160	20	1,8	60	2,4	0	9.540	1
B-09569	B-33249	160	30	1,8	60	2,4	0	9.540	1
B-09307	B-33021	165	20	1,7	56	2,4	-3	9.250	1
B-56714	B-56770	165	20	1,4	56	2	-3	9.250	1
B-56552	B-56568	165	20	1,2	60	1,8	5	9.250	1
B-09575	B-33255	180	30	1,8	60	2,4	0	8.480	1

Cod	Cod înlocuitor	Diametru (mm)	Alezaj (mm)	Grosime disc (mm)	Număr dinți	Grosime tăiere (mm)	Unghi tăiere (°)	Turație maximă (min ⁻¹)	Ambalare (buc./set)
B-09597	B-33261	190	30	1,8	60	2,4	0	8.040	1
B-09612	B-33283	190	20	1,4	60	2	-5	8.040	1
B-09690	B-33364	200	30	2,2	64	2,8	0	7.630	1
B-09628	B-33299	216	30	1,6	64	2,2	-5	7.070	1
B-09606	B-33277	235	30	1,8	80	2,4	0	6.500	1
B-09634	B-33308	250	30	1,8	80	2,4	-5	6.110	1
B-09640	B-33314	250	30	1,8	100	2,4	-5	6.110	1
B-09709	B-33370	250	30	2,2	80	2,8	0	6.110	1
B-09656	B-33320	260	30	1,8	80	2,4	-5	5.870	1
B-09662	B-33336	260	30	1,8	100	3	-5	5.870	1
B-09715	B-33386	260	30	2,2	80	2,8	0	5.870	1
B-09721	B-33392	300	30	2,2	80	2,8	0	5.090	1
B-09678	B-33342	305	30	1,8	80	2,4	-5	5.000	1
B-09684	B-33358	305	30	1,8	100	2,4	-5	5.000	1
B-09737	B-33401	350	30	2,6	100	3,2	0	4.360	1
D-72970	D-81371	190	30(20)	1,4	60	2,2	5	8.040	1
D-72986	-	210	30	1,6	60	2,4	5	7.170	1
D-72992	-	235	30	1,6	80	2,4	5	6.500	1
D-73003	D-81723	260	30	1,8	70	2,8	5	5.870	1
D-73019	D-81898	305	30	2	80	2,8	5	5.000	1
D-73025	D-81963	305	30	2	100	2,8	5	5.000	1
D-61880	D-81826	260	30	1,8	120	2,6	5	-	1
D-61874	D-81795	260	30	1,8	100	2,6	5	-	1

Discuri specializate pentru tăiere panouri sandwich

Discuri specializate pentru tăierea materialelor compozite metalice. Sunt proiectate pentru a realiza o tăiere netedă și curată, fara a lăsa suprafețe aspre. În acest fel se generează mai puțină căldură, ceea ce protejează miezul izolator al panoului sandwich de deteriorare.



Cod	Cod înlocuitor	Diametru (mm)	Alezaj (mm)	Grosime disc (mm)	Număr dinți	Grosime tăiere (mm)	Unghi tăiere (°)	Turație maximă (min ⁻¹)	Ambalare (buc./set)
B-63133	B-63149	165	20	1,4	42	1,75	0	9.250	1
B-17675	B-33582	235	30	1,8	50	2,2	0	6.500	1
B-17681	B-33598	270	30	2	60	2,4	0	5.650	1
B-17697	B-33607	355	30	2,2	80	2,6	0	4.300	1

Discuri fierăstrău MAKBlade

O gamă largă de discuri de fierăstrău pentru toate tipurile de fierăstraie circulare. Cu diametre cuprinse între 190 și 305 mm și număr de dinți de la 24 la 100, discurile MAKBlade permit multiple tipuri de tăieri de la tăiere grosiere la tăiere fină.

MAKBLADE

Cod	Cod înlocuitor	Diametru (mm)	Alezaj (mm)	Grosime disc (mm)	Număr dinți	Grosime tăiere (mm)	Ungchi tăiere (°)	Turație maximă (min ⁻¹)	Ambalare (buc./set)
B-08894	B-32708	190	20	1,6	24	2,2	5	8.040	1
B-08872	B-32683	216	30	1,6	40	2,1	10	7.070	1
B-08969	B-32764	216	30	1,6	48	2,4	5	7.070	1
B-09058	B-32839	216	30	1,4	60	2	5	7.070	1
B-09092	B-32867	216	30	1,8	100	2,8	5	7.070	1
B-08919	-	250	30	1,6	32	2,4	5	6.110	1
B-08975	-	250	30	1,8	48	2,4	5	6.110	1
B-09008	-	250	30	1,8	60	2,3	5	6.110	1
B-09064	-	250	30	1,8	72	2,4	5	6.110	1
B-09101	-	250	30	1,8	100	2,3	5	6.110	1
B-08888	B-32699	255	30	1,6	48	2,1	10	5.990	1
B-08925	B-32720	255	30	1,8	32	2,3	5	5.990	1
B-09014	B-32792	255	30	1,8	60	2,3	5	5.990	1
B-08931	B-32736	260	30	1,8	32	2,3	5	5.870	1
B-08981	B-32770	260	30	1,8	40	2,3	5	5.870	1
B-09020	B-32801	260	30	1,8	60	2,3	5	5.870	1
B-09070	B-32845	260	30	1,8	80	2,3	5	5.870	1
B-09117	B-32873	260	30	1,8	100	2,3	5	5.870	1
B-08947	B-32742	305	30	1,8	32	2,3	5	5.000	1
B-08997	B-32786	305	30	1,8	40	2,3	5	5.000	1
B-09036	B-32817	305	30	1,8	60	2,3	5	5.000	1
B-09086	B-32851	305	30	1,8	80	2,3	5	5.000	1
B-09123	B-32889	305	30	1,8	100	2,3	5	5.000	1

Discuri MAKBlade - 2712



Cod	Cod Makita	Diametru (mm)	Alezaj (mm)	Grosime disc (mm)	Număr dinți	Grosime tăiere (mm)	Ungchi tăiere (°)	Turație maximă (min ⁻¹)	Ambalare (buc./set)
B-46171	TSC31528G	315	30	2,0	28	2,8	20	4.850	1
B-46187	TSM31548G	315	30	2,0	48	2,8	10	4.850	1
B-46193	TSF31560G	315	30	2,0	60	2,8	10	4.850	1

Discuri fierăstrău MAKBlade Plus

Discurile MAKBlade Plus pentru fierăstraie au o tehnologie unică și brevetată. Sunt proiectate să reducă vibrațiile și sunt extrem de silențioase. Acest lucru asigură un mediu de lucru plăcut, sunt mai durabile și oferă un nivel ridicat de fiabilitate pentru fierăstraie. Datorită vibrațiilor reduse tăierea este mai precisă și mai netedă.

MAKBLADE PLUS

Cod	Cod înlocuitor	Diametru (mm)	Alezaj (mm)	Grosime disc (mm)	Număr dinți	Grosime tăiere (mm)	Unghi tăiere (°)	Turație maximă (min ⁻¹)	Ambalare (buc./set)
B-56502	B-56518	165	20	1,4	64	1,9	10	9.250	1
B-08791	B-32627	216	30	1,8	80	2,8	5	7.070	1
B-08838	-	250	30	1,8	80	2,8	15	6.110	1
B-08654	B-32487	260	30	1,8	40	2,3	5	5.870	1
B-04597	B-08707	260	30	1,8	70	2,3	5	5.870	1
B-08707	B-32530	260	30	1,8	70	2,3	5	5.870	1
B-08779	B-32605	260	30	1,8	80	2,3	5	5.870	1
B-08800	B-32633	260	30	1,8	100	2,3	5	5.870	1
B-17712	-	260	30	1,6	24	2,3	20	5.870	1
B-09830	B-33504	300	30	1,8	48	2,8	20	5.090	1
B-08660	B-32493	305	30	1,8	40	2,3	5	5.000	1
B-08729	B-32552	305	30	2	60	2,6	5	5.000	1
B-08816	B-32649	305	30	1,8	100	2,3	5	5.000	1
B-09846	B-33510	350	30	2,5	56	3,5	20	4.360	1
B-08741	B-32574	355	30	2,2	80	3	5	4.300	1

Discuri fierăstrău MAKForce

O gamă largă de discuri de fierăstrău pentru toate tipurile de fierăstraie circulare portabile. Cu o gamă largă de dimensiuni de la 140 la 355 mm și număr de dinți de la 10 la 60, discurile MAKForce permit o gamă largă de aplicații.

MAKFORCE

Cod	Cod înlocuitor	Diametru (mm)	Alezaj (mm)	Grosime disc (mm)	Număr dinți	Grosime tăiere (mm)	Unghi de tăiere (°)	Turație maximă (min ⁻¹)	Ambalare (buc./set)
B-08143	B-32091	160	20	1,5	16	2,4	20	9.540	1
B-08296	B-32203	160	20	1,5	24	2,4	20	9.540	1
B-08420	B-32297	160	20	1,5	40	2,4	20	9.540	1
B-08159	B-32100	165	20	1,4	10	2	20	9.250	1
B-08305	B-32219	165	30	1,5	24	2,4	20	9.250	1
B-08436	B-32306	165	30	1,5	40	2,4	20	9.250	1
B-08187	-	180	20	1,5	16	2,4	20	8.480	1
B-08349	-	185	15,88	1,2	24	1,8	20	8.250	1
B-08224	B-32144	190	30	1,4	12	2	20	8.040	1
B-08355	B-32247	190	30	1,4	24	2,2	20	8.040	1
B-08486	B-32340	190	30	1,4	40	2,2	20	8.040	1
B-32390	-	190	30	1,4	60	2,2	15	80400	1
B-08230	B-32150	210	30	1,6	16	2,4	20	7.300	1
B-08377	B-32253	210	30	1,6	24	2,4	20	7.300	1
B-08501	B-32356	210	30	1,6	40	2,4	20	7.300	1
B-08246	-	230	30	1,6	18	2,6	20	6.640	1

Cod	Cod înlocuitor	Diametru (mm)	Alezaj (mm)	Grosime disc (mm)	Număr dinți	Grosime tăiere (mm)	Unghi de tăiere (°)	Turație maximă (min ⁻¹)	Ambalare (buc./set)
B-08383	-	230	30	1,6	24	2,3	20	6.640	1
B-08517	-	230	30	1,6	40	2,6	20	6.640	1
B-08567	-	230	30	1,8	60	2,8	15	6.640	1
B-08252	B-32166	235	30	1,6	18	2,6	20	6.500	1
B-08399	B-32269	235	30	1,6	20	2,3	20	6.500	1
B-08523	B-32362	235	30	1,6	40	2,6	20	6.500	1
B-08589	B-32415	235	30	1,8	60	2,8	15	6.500	1
B-08268	B-32172	270	30	1,8	24	2,6	20	5.650	1
B-08539	B-32378	270	30	1,6	40	2,6	20	5.650	1
B-08573	B-32409	270	30	1,8	60	2,8	15	5.650	1
B-08274	B-32188	355	30	2,2	24	3	20	4.300	1
B-08414	B-32281	355	30	2,2	40	3	20	4.300	1
B-08545	B-32384	355	30	2,2	60	3	20	4.300	1
B-08595	B-32421	355	30	1,8	60	2,8	15	4.300	1

Discuri fierăstrău MForce

Designul revoluționar și avansat al dinților stabilește noi repere în tehnologia discurilor pentru fierăstrău. Discurile au dinți curbați bilateral cu muchii mai ascuțite, iar forma M mărește eficiența tăierii ca și cum lama de fierăstrău ar avea un număr dublu de dinți. Lamele de fierăstrău MForce au o durată de viață aproape de două ori mai mare decât cele convenționale. Lama îngustă și creștăturile reduc frecarea și permit o presiune mai mică asupra piesei de prelucrat și protejează motorul fierăstrăului.



Cod	Cod înlocuitor	Diametru (mm)	Alezaj (mm)	Grosime disc (mm)	Număr dinți	Grosime tăiere (mm)	Unghi tăiere (°)	Turație maximă (min ⁻¹)	Ambalare (buc./set)
B-07886	B-31918	165	20	1,2	10	2	15	9.250	1
B-07901	B-31930	165	20	1,2	16	2	15	9.250	1
B-08006	B-32007	165	20	1,2	24	2	15	9.250	1
B-07923	-	180	20	1,2	16	2	15	8.480	1
B-08034	B-32029	180	30	1,2	24	2	15	8.480	1
B-07945	B-31968	185	30	1,2	16	2	15	8.250	1
B-08040	B-32035	185	30	1,2	24	2	15	8.250	1
B-07951	-	190	15,88	1,2	12	2	15	8.040	1
B-07967	B-31974	190	30	1,2	12	2	15	8.040	1
B-08056	B-32041	190	30	1,2	24	2	15	8.040	1
B-08062	-	190	15,88	1,2	24	2	15	8.040	1
B-32041	-	190	30	1,4	24	2	15	8.040	1
B-07973	B-31980	210	30	1,4	16	2,3	15	7.300	1
B-08078	B-32057	210	30	1,4	24	2,3	15	7.300	1
B-08109	B-32079	210	30	1,4	40	2,3	15	7.300	1
B-07989	-	230	30	1,6	18	2,3	15	6.640	1
B-08084	-	230	30	1,6	24	2,3	15	6.640	1
B-08090	B-32063	235	30	1,6	24	2,3	15	6.500	1
B-08121	B-32085	235	30	1,6	40	2,3	15	6.500	1

Discuri multimaterial pentru fierăstraie circulare



Cod	Diametru (mm)	Alezaj (mm)	Grosime disc (mm)	Număr dinți	Grosime tăiere (mm)	Unghi tăiere (°)	Turație maximă (min ⁻¹)	Ambalare (buc./set)
D-65567	160	20	1,4	60	2.2	5	9.450	1
D-65573	165	20	1,4	60	2.2	5	9.250	
D-65589	185	30	1,4	60	2.2	5	8.300	
D-65595	190	30	1,4	60	2.2	5	8.040	
D-65604	210	30	1,6	60	2.4	5	7.170	
D-65632	235	30/25,4	1,6	60	2.4	5	6.500	

Discuri multimaterial pentru fierăstraie de masă



Cod	Diametru (mm)	Alezaj (mm)	Grosime disc (mm)	Număr dinți	Grosime tăiere (mm)	Unghi tăiere (°)	Turație maximă (min ⁻¹)	Ambalare (buc./set)
D-65610	216	30	1.6	60	2,4	5	7.070	1
D-65626	216	30	1.6	80	2,4	5	7.070	
D-65648	260	30	1.8	80	2,6	5	5.870	
D-65654	260	30	1.8	100	2,6	5	5.870	
D-65660	260	30	1.8	120	2,6	5	5.870	
D-65676	305	30	2	80	2,8	5	5.000	
D-65682	305	30	2	100	2,8	5	5.000	
D-65698	305	30	2	120	2,8	5	5.000	
D-65707	355	30	2,2	100	3	5	4.300	

Discuri fierăstrău TCT pentru lemn

Discuri pentru fierăstrău pentru lemn îmbunătățite pentru un raport excelent preț calitate.



Cod	Diametru (mm)	Alezaj (mm)	Grosimea discului (mm)	Număr dinți	Turație maximă (min ⁻¹)	Grosimea tăierii (mm)	Unghi tăiere (°)	Ambalare (buc./set)
D-52560	165	20	2	24	9250	2	2	1
D-52598	185	30	1.4	24	8040	2,2	15	1
D-52607	185	30	1.4	40	8,040	2,2	15	1
D-03919	185	30	1.4	40	8,040	2,2	15	1
D-52607-10	185	30	1.4	40	8,040	2,2	15	10
D-64951	190	30	1,4	24	8.040	2,2	15	1
D-64967	190	30	1,4	40	8.040	2,2	15	1

Cod	Diametru (mm)	Alezaj (mm)	Grosimea discului (mm)	Număr dinți	Turație maximă (min ⁻¹)	Grosimea tăierii (mm)	Unghi tăiere (°)	Ambalare (buc./set)
D-65377	260	30	1,8	40	5.870	2,6	15	1
D-65383	260	30	1,8	60	5.870	2,6	15	1
D-65399	260	30	1,8	80	5.870	2,6	12	1
D-65408	260	30	1,8	100	5.870	2,6	12	1
D-74049	255	30	1,8	40	5.870	2,6	15	1
D-74077	260	30	1,8	40	5.870	2,6	15	1
D-77322	260	30	1,8	40	5.870	2,6	18	1



Inele reductoare pentru discurile TCT

Cod	Diametru exterior (mm)	Diametru interior (mm)	Grosime disc (mm)	Ambalare (buc./set)
B-20987	20	15,88	1,2	1
B-20993	20	15,88	1,8	1
B-21004	30	15,88	1,2	1
B-21010	30	15,88	1,8	1
B-21026	30	20	1,2	1
B-21032	30	20	1,4	1
B-21048	30	20	1,8	1
B-21060	30	25,4	1,4	1
B-21076	30	25,4	2,2	1



LAME PENTRU FIERĂSTRAIE

FORMA DINȚILOR

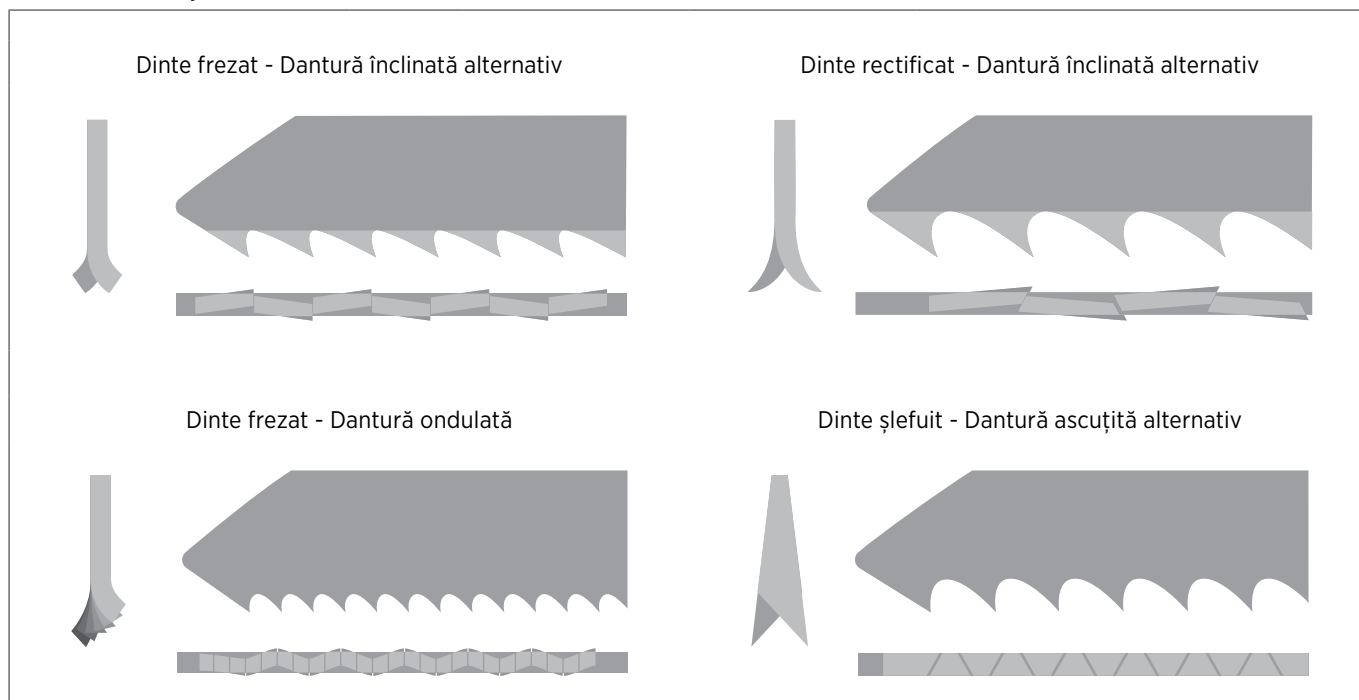

COMPARAȚIA FORMEI ȘI DESCHIDERII DINȚILOR

DINTE FREZAT	DINTE RECTIFICAT
<p>Dinți foarte ascuțiți. Tăiere precisă și curată. Pentru materiale moi și de duritate medie.</p> 	<p>Tăiere standard. Pentru materiale cu duritate de la mică la mare. Durată de viață extinsă a lamei.</p> 

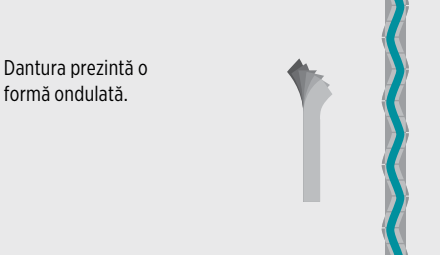
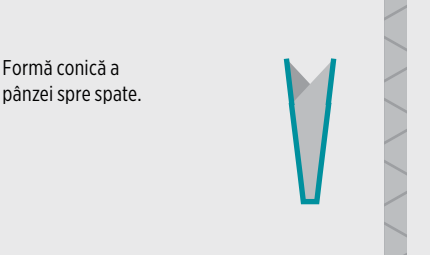
LATERAL	ONDULAT	RECTIFICAT
<p>Fiecare dinte este alternativ orientat spre stânga sau dreapta.</p> 	<p>Dantura prezintă o formă ondulată.</p> 	<p>Formă conică a pânzei spre spate.</p> 

MATERIALUL DE PRODUCȚIE

HCS (High Carbon Steel) pentru materiale moi, de exemplu lemn și materiale plastice.

HSS (High Speed Steel) pentru materiale dure cum ar fi metalul.

BIM (Bi-metal, bază HCS și dinți HSS) pentru materiale moi spre dure, lemn, metal, mase plastice.

TC (Carbură tungsten) pentru tăieri dure, fibră de sticlă, fibrociment.

LAME PENTRU FIERĂSTRAIE PENDULARE
Lame HCS pentru lemn, tăieri grosiere

	Cod	Tipul lamei	Lungime de lucru (mm)	Număr dinți	Lemn moale / dur (mm)	Plastic (mm)	Ambalare (buc./set)
	A-85656	B-13	70	8	4-65	4-65	5/1
	A-85662	B-14	51	18	2-35	2-35	5/1
	A-85678	B-15	50	12	3-35	3-35	5/1
	A-85709	B-18	44	14	2-35	2-35	5/1
	A-85793	BR-13	64	9	5-65		5/1

Lame HCS pentru tăiere fină

	Cod	Tipul lamei	Lungime de lucru (mm)	Număr dinți	PAL (mm)	Lemn moale / dur (mm)	Plastic (mm)	Ambalare (buc./set)
	A-85628	B-10	76	9	3-65	3-65	3-65	5/1
	A-85634	B-11	73	9	3-60	3-60	3-60	5/1
	A-85640	B-12	74	6	5-65	5-65	5-65	5/1
	A-85715	B-19	63	12	3-50	3-50	3-50	5/1
	A-86290	L-1	101	6	5-90	5-90	5-90	5/1
	D-44214	T101B	100	9	-	-	-	5/1

Lame HCS pentru lemn, tăiere rapidă

	Cod	Tipul lamei	Lungime de lucru (mm)	Număr dinți	PAL (mm)	Lemn moale / dur (mm)	Plastic (mm)	Ambalare (buc./set)
	A-85232	B-8	75	8	4-65	4-65	4-65	5/1
	A-85684	B-16	75	6	5-65	5-65	5-65	5/1
	A-85690	B-17	71	6	5-60	5-60	5-60	5/1
	A-86309	L-2	101	6	5-90	5-90	5-90	5/1
	A-86315	L-10	151	6	5-135	5-135	5-135	5/1
	A-86577	58	75	8		4-65	4-65	5/1
	D-34883	B-16	74	6	4-50	4-50	4-50	5/1

Lame HSS pentru metal, tăiere universală



	Cod	Tip lamă	Lungime de lucru (mm)	Număr dinți	Aluminiu (mm)	Plastic (mm)	Oțel inoxidabil (mm)	Metal (mm)	Ambalare (buc./set)
	A-85721	B-21	73	12	1-10	3-60			5/1
	A-85737	B-22	52	24	1-3	1-6	1-3	1-3	5/1
	A-85743	B-23	51	14	2-6	3-35	2-6	2-6	5/1
	A-85759	B-24	52	32	1-2	1-3	0,5-2	0,5-2	5/1
	A-85771	B-26	71	9	3-10	3-60	3-10	3-10	5/1
	A-85787	B-27	52	24	1-3	1-6	1-3	1-3	5/1
	B-04961	B-30	50	24	1-3	1-6	1-3	1-3	5/1

Lame BiM pentru laminat



	Cod	Tip lamă	Lungime de lucru (mm)	Număr de dinți	Laminat (mm)	Ambalare (buc./set)
	B-10970	B-53	59	15	1,5-15	5/1

Lame HCS pentru tăiere curbilinie



	Cod	Tip lamă	Lungime de lucru (mm)	Număr de dinți	Laminat (mm)	Ambalare (buc./set)
	E-22218	B-10	105	9	1,5-15	5/1

Lame specializate pentru diverse materiale



	Cod	Tip lamă	Material lamă	Lungime de lucru (mm)	Spațiere dinți (mm)	Număr dinți	Potrivit pentru	Ambalare (buc./set)
	A-85765	B-25	HSS	74	2,8	9	lemn tare, moale, plastic, metal, metale neferoase	5/1
	B-06909	B-61	HM	105	/	6	plăci rigips 5-80 mm, plastic 5-50 mm	3/1
	P-05929	/	HM	50	/	24	metale, oțel inoxidabil	1
	P-47204	/	Bi-Metal	105	/	24	materiale sandwich, carton, metale	5/1
	P-49644	/	Bi-Metal	155	/	24	material izolator, carton	5/1

Lame Super Express, tăiere super rapidă

Lame revoluționare cu un design progresiv al dinților ce pot tăia cu ușurință materiale subțiri sau groase. Sunt ideale pentru fierăstraie cu acumulatori deoarece folosesc mai puțină energie datorită formei lor înguste, ceea ce sporește autonomia per ciclu de încărcare.



	Cod	Tip lamă	Material lamă	Lungime de lucru (mm)	Număr dinți	Aluminiu (mm)	Plastic (mm)	Oțel inoxidabil (mm)	Ambalare (buc./set)
	B-06460	B-50	HCS	73	8,5-10,6		5-50		5/1
	B-06476	B-51	HSS	73	9,8-18,1	1-10	1-3	1-3	5/1
	B-06482	B-52	HSS	73	5,5-9,8	3-35	3-35	3-8	5/1

Seturi mixte de lame



	Cod	Descriere	Tip lamă	Material lamă	Ambalare (buc./set)
	A-86898	Set mix 5 lame	B-10S, B-13, B-16, B-22, B-23	HCS, HSS	5/1

Alte accesorii











	Cod	Descriere	Pentru modelul	Ambalare (buc./set)
	123030-5	Ghid circular	4300BA, 4300BV	1
	126331-0	Duză de extragere a prafului	DJV181, DJV182	1
	192561-5	Ghidaj circular	4304T, 4331, 4333	1
	192732-4	Ghidaj paralel și circular	DJV181, DJV182, 4329, 4350CT, 4350FCT, 4351CT, 4351FCT, JV0600, JV100D	1
	193516-3	Ghidaj paralel și circular	4350CT, 4350FCT, 4351CT, 4351FCT, JV0600, DJV181, DJV182, JV103	1
	197252-3	Adaptor ghidaj pentru A, B și JV la instalarea pe șina de ghidare	DHS630, DHS710, HS7101, HS6101, 4350CT, 4350FCT, 4351CT, 4351FCT, DJV180, DJV181, DJV182	1

	Cod	Descriere	Pentru modelul	Ambalare (buc./set)
	415524-7	Placă de protecție	4329, 4340CT, 4340FCT, 4341CT, 4341FCT, 4350CT, 4350FCT, 4351CT, 4351FCT, DJV180, DJV181, DJV182, JV103	1
	417852-6	Placă acoperire	4350CT, 4350FCT, 4351CT, 4351FCT, DJV180, DJV181, DJV182	1

LAME PENTRU FIERĂSTRAIE ALTERNATIVE





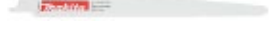

Lame pentru tăierea lemnului











	Cod	Material lamă	Grosime lamă (mm)	Lungime totală (mm)	Număr dinți	Lemn moale / tare (mm)	Plastic (mm)	Lemn cu cuie (mm)	Ambalare (buc./set)
	B-03030	HCS	1,25	300	6	5-250	135-280	-	5/1
	B-05175	Bi-Metal	1,25	152	6	50-100	5-135	10-100	5/1
	D-53089	HCS	1,25	152	6	-	-	-	2/1
	B-31843	Bi-Metal	0,9	152	10	5-100	-	5-100	5/1
	B-31859	Bi-Metal	0,9	228	10	5-175	-	5-175	5/1
	P-04999	HSS	0,9	150	4	8-100	0-100	-	5/1
	P-05000	HSS	0,9	150	10	5-100	-	-	5/1
	P-05016	HSS	0,9	300	6	6-250	6-250	-	5/1
	P-05022	HSS	0,9	150	6	6-100	6-100	-	5/1
	P-05072	HSS	1,27	300	4-6,5	3-250	-	-	5/1
	P-46975	Bi-Metal	-	255	10	-	-	-	3/1

Lame pentru tăierea metalului









	Cod	Material lamă	Lungime totală (mm)	Grosime lamă (mm)	Număr dinți	Aluminiu (mm)	Metal (mm)	Inox (mm)	Ambalare (buc./set)
	B-05169	Bi-Metal	152	0,9	18	1,5-3	1,5-4	-	5/1
	P-04874	Bi-Metal	100	0,9	18	-	1,5-2,5	1,5-3	5/1
	P-04880	Bi-Metal	150	0,9	18	-	1,5-2,5	1,5-3	5/1
	P-04896	Bi-Metal	100	0,9	24	1-6	1,2-2	1,5-3	5/1
	P-04905	Bi-Metal	150	0,9	24	1,5-4	1,2-3	1,2-3	5/1
	P-04911	Bi-Metal	150	0,9	14	-	2,5-3,5	-	5/1









	Cod	Material lamă	Lungime totală (mm)	Grosime lamă (mm)	Număr dinți	Aluminiu (mm)	Metal (mm)	Inox (mm)	Ambalare (buc./set)
	P-04927	Bi-Metal	200	0,9	14	1,2-3,5	2,5-3,5	1,2-3,5	5/1
	P-04933	Bi-Metal	200	0,9	18		1,5-3	1,5-3	5/1
	P-04949	Bi-Metal	200	0,9	24	1,5-3	1,2-3	1,2-2	5/1
	P-04955	Bi-Metal	150	0,9	32	1,2-3,5	1,2	0,5-1	5/1
	P-04983	Bi-Metal	280	0,9	10	3,5-5	3,5-5	3,5-5	5/1
	P-05088	Bi-Metal	150	1,27	6	-	-	-	5/1
	B-43212	Bi-Metal	305	1,1	8+10	-	-	-	5/1
	D-80341	Bi-Metal	225	0,9	24	-	-	-	2/1
	D-80335	Bi-Metal	150	0,9	24	-	-	-	2/1



Lame pentru materiale de construcții



	Cod	Material lamă	Grosime lamă (mm)	Lungime totală (mm)	Număr dinți	Metal (mm)	Cărămidă siporex (mm)	Beton aerat (mm)	Lemn cu cuie (mm)	Ambalare (buc./set)
	B-10394	HM	1,5	305	2	-	0-215	-	-	1
	B-10403	HM	1,5	455	2	-	0-365	-	-	1
	B-49834	TC/HM	1,25	152	6-8	-	-	-	5-100	1
	B-49840	TC/HM	1,25	228	6-8	-	-	-	5-175	1
	B-49856	TC/HM	1,25	305	6-8	-	-	-	5-250	1
	P-05044	HM	1,3	150	6	0-130	0-130	0-130	-	1
	P-05066	HM	1,3	400	3	0-380	0-380	0-380	-	1



Lame specializate pentru materiale variate

	Cod	Material lamă	Lungime totală (mm)	Grosime lamă (mm)	Număr dinți	Potrivit pentru	Ambalare (buc./set)
	B-55566	TC/HM	100	1,25	8	metal, fontă, inox	1
	B-07250	TC/HM	152	1,0	18	panouri din oțel 2-4 mm, țevi inox până la 80 mm diametru, fibră de sticlă	2/1
	B-55572	TC/HM	152	1,25	8	metal, fontă, inox	1
	B-51312	TC/HM	203	1,0	18	panouri inox 2-4 mm, țevi de până la 1500, fibră de sticlă	2/1
	B-52118	HCS	225	1,5		lemn moale	2/1
	B-55588	TC/HM	228	1,25	8	ramuri de 160 mm, bambus de până la 160 mm	1
	B-52124	HCS	300	1,5		materiale izolante, fibră de sticlă	2/1
	B-55594	TC/HM	305	1,25	8	metal, fontă, inox	1
	B-63585	HM	305	1,5	3	BCA, cărămidă, rigips	1

	Cod	Material lamă	Lungime totală (mm)	Grosime lamă (mm)	Număr dinți	Potrivit pentru	Ambalare (buc./set)
	B-52130	HCS	400	1,5		materiale izolante, fibră de sticlă	1
	B-63591	HM	400	1,5	2	beton aerat, cărămidă ignifugă, gresie, tencuială	1

Lame pentru intervenții de salvare







	Cod	Material lamă	Lungime totală (mm)	Grosime lamă (mm)	Număr dinți	Potrivit pentru	Ambalare (buc./set)
	B-67206	TC/HM	152	1,25	6-8	Materiale diverse	1
	B-67212	TC/HM	225	1,25	6-8	Materiale diverse	1

Lame Super Express, tăiere super rapidă

Lame revoluționare cu un design progresiv al dinților ce pot tăia cu ușurință materiale subțiri sau groase. Lamele sunt ideale pentru fierăstraie cu acumulatori deoarece folosesc mai puțină energie datorită formei lor înguste, ceea ce sporește autonomia per ciclu de încărcare.



	Cod	Material lamă	Lungime totală (mm)	Grosime lamă (mm)	Număr dinți	Potrivit pentru	Ambalare (buc./set)
	B-05038	Bi-Metal	152	0,9	7-18	tăiat rapid în metal (fier oțelită) 1,5-8 mm, aluminiu 1-10 mm, plastic 5-77 mm	5/1
	B-05044	Bi-Metal	152	0,9	6-11	tăiere rapidă în metal (fier, oțel, aluminiu) 5-8 mm, plastic 5-77 mm, lemn 77 mm	5/1
	B-05153	HCS	203	1,0	6-10	tăiere rapidă în lemn 5-150 mm, plastic 5-150 mm, panouri/PAL 6-60 mm	5/1
	B-05153-2	HCS	203	1,0	6-10	tăiere rapidă în lemn 5-150 mm, plastic 5-150 mm, panouri/PAL 6-60 mm	2/1

Lame pentru gheață



Cod	Material lamă	Lungime totală (mm)	Grosime lamă (mm)	Număr dinți	Potrivit pentru	Ambalare (buc./set)
B-10609	Oțel inoxidabil	305	1,25	3	gheață / materiale înghețate	1
B-23248	Oțel inoxidabil	300	1,2	6	gheață / materiale înghețate	1
B-23254	Oțel inoxidabil	300	1,2	10	gheață / materiale înghețate	1

Seturi de lame mixte

	Cod	Descriere	Material lamă	Tip lamă	Lungime totală (mm)	Grosime lamă (mm)	Ambalare (buc./set)
	792003-5	Set complet de lame pentru fierăstrău tip sabie pentru lemn și metal	HCS, HSS		125, 2x165		3/1
	B-13677	Set lame Super Express	Bi-Metal, HCS		152, 152, 203	0.9, 0.9, 1.0	3/1

Lame pentru fierăstrău JR100D

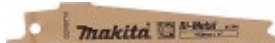
	Cod	Material lamă	Lungime totală (mm)	Număr dinți	Potrivit pentru	Ambalare (buc./set)
	B-20432	Bi-Metal	100	6	lemn esență tare, lemn cu cuie	5/1

ACCESORII PENTRU FIERĂSTRAIE CU BANDĂ









Lame fierăstrău

















Cod	Material lamă	Lungime totală (mm)	Lățime lamă (mm)	Capacitate max de tăiere (mm)	Număr de dinți per inch	Potrivit pentru	Pentru modelul	Ambalare (buc./set)
194692-6	HSS	1.140	13	< 4	24	plastic, metale neferoase, oțel, piese turnate din fier, fontă, oțel inoxidabil, oțel călit	2106, 2107FK, DPB180	1
792556-4	HSS	1.140	13	4-5	18	plastic, metale neferoase, oțel, piese turnate din fier, fontă, oțel inoxidabil, oțel călit	2106, 2107FK, DPB180	1
792557-2	HSS	1.140	13	> 5	14	plastic, metale neferoase, oțel, piese turnate din fier, fontă, oțel inoxidabil, oțel călit	2106, 2107FK, DPB180	1
792558-0	aliaj oțel carbon	1.140	13	< 4	24	plastic, metale neferoase, oțel moale, fontă	2106, 2107FK, DPB180	3/1
792559-8	aliaj oțel carbon	1.140	13	4-5	18	plastic, metale neferoase, oțel moale, fontă	2106, 2107FK, DPB180	3/1
792560-3	aliaj oțel carbon	1.140	13	> 5	14	plastic, metale neferoase, oțel moale, fontă	2106, 2107FK, DPB180	3/1
792567-9	aliaj oțel carbon	1.140	13	/	6	lemn	2106, 2107FK, DPB180	3/1
B-40543	BiM	835	13	3-6	14	plastic, metale neferoase, oțel, piese turnate din fier, fontă, oțel inoxidabil, oțel călit	DPB181, DPB182	5/1
B-40559	BiM	835	13	2-3	18	plastic, metale neferoase, oțel, piese turnate din fier, fontă, oțel inoxidabil, oțel călit	DPB181, DPB182	5/1
B-40565	BiM	835	13	< 2	24	plastic, metale neferoase, oțel, piese turnate din fier, fontă, oțel inoxidabil, oțel călit	DPB181, DPB182	5/1
B-16673	/	2.240	13	/	4	lemn	LB1200F	3/1
B-16689	/	2.240	6	/	6	lemn	LB1200F	3/1
B-16695	/	2.240	16	/	14	metal	LB1200F	3/1
JM21080294	/	2.240	6	/	6	lemn	LB1200F	1

Cod	Material lamă	Lungime totală (mm)	Lățime lamă (mm)	Capacitate max de tăiere (mm)	Număr de dinți per inch	Potrivit pentru	Pentru modelul	Ambalare (buc./set)
B-30128	/	1140	13	> 5,5	10	plastic, metale neferoase, oțel, piese turnate din fier, fontă, oțel inoxidabil, oțel călit	/	1
JM21080295	/	2.240	13	/	4	lemn	LB1200F	1

Accesorii diverse

	Cod	Descriere	Pentru modelul	Ambalare (buc./set)
	197975-3	Capac protecție	DPB181, DPB182	1
	JM21000300	Extensie masă	LB1200F	1
	JM21000320	Extensie tăieri circulare	LB1200F	1
	JM21000330	Accesoriu șlefuitor cu bandă (hârtie 2.240x20mm)	LB1200F	1
	JM21080230	Limitator lateral	LB1200F	1
	JM21080260	Ghidaj unghiular	LB1200F	1
	JM21080290	Tijă de împingere	LB1200F, LH1200FL	1
	JM23300008	Limitator lateral	LH1200FL	1
	199376-1	Ghidaj fierăstraie înclinate	2704, 2704N	1



ALTE ACCESORII PENTRU TĂIERE
Accesorii pentru șine de ghidare

	Cod	Descriere	Pentru modelul	Ambalare (buc./set)
	165447-6	Ghidaj paralel	-	1
	194367-7	Șină de ghidare 3.000 mm	-	1
	194368-5	Șină de ghidare 1.400 mm	-	1
	194385-5	Set de 2 menhine	-	2/1
	194416-0	Bandă glisare 10.000 mm	-	1
	194417-8	Bandă cauciucată anti-alunecare 10.000 mm	-	1
	194925-9	Șină ghidare 1.900 mm	-	1
	196664-7	Ghidaj unghiular reglabil	-	1
	198885-7	Conector șină ghidare	-	2/1
	199141-8	Șină ghidare 1.500 mm	-	1
	199826-6	Set menhine rapide pentru șine ghidare	-	2/1
	413101-9	Bandă cauciucată 1.400 mm	-	1
	413102-7	Bandă cauciucată 3.000 mm	-	1
	423359-2	Bandă cauciucată anti-alunecare 1.400 mm	-	1

	Cod	Descriere	Pentru modelul	Ambalare (buc./set)
	423360-7	Bandă cauciucată anti-alunecare 3.000 mm	-	1
	423361-5	Bandă cauciucată anti-alunecare 1.400 mm	-	1
	423362-3	Bandă cauciucată anti-alunecare 3.000 mm	-	1
	E-05670	Geantă textilă pentru șine ghidare 1.000 mm	-	1
	194579-2	Adaptor șine ghidare 1.400/3.000 mm	3612, 3612C, RP0900, RP0910, RP1110C, RP1800FC, RP1801, RP2300FCX, RP2301, RT0700C	1
	198673-2	Adaptor ghidaj	4100NH2, 4100KB	1
	193517-1	Adaptor șină de ghidare	4329, 4350CT, 4350FCT, 4351CT, 4351FCT, DJV181, DJV182, JV0600K, JV100D, JV101D, JV102D, JV103D	1
	192507-1	Adaptor șină de ghidare	5103R	1
	165108-8	Ghidaj paralel	5603R, 5017RKB, 5705R	1
	192505-5	Adaptor instalare șină de ghidare	5603R, 5017RKB, 5705R, 5703R	1
	164095-8	Ghidaj paralel	5604R, 5704R, DHS630, DHS710, DSS610, DSS500, DSS501, HS300, HS7100, HS7101, HS6100, HS6101, 5008MG	1
	192506-3	Adaptor instalare șină de ghidare	5903R	1
	165084-6	Ghidaj paralel	5903R, 5103R, 5104S	1
	197252-3	Adaptor A, B și JV pentru șine de ghidare	DHS630, DHS710, HS7101, HS6101, 4350CT, 4350FCT, 4351CT, 4351FCT, DJV180, DJV181, DJV182	1





	Cod	Descriere	Pentru modelul	Ambalare (buc./set)
	199232-5	Adaptor şină de ghidare pentru circular	DHS661	1
	196953-0	Adaptor D pentru şină de ghidare	DHS680	1
	198570-2	Adaptor şină ghidaj pentru circular	HS0600	1
	197462-2	Adaptor pentru şină de ghidare	HS6601, HS6600	1
	197005-0	Adaptor C pentru şină de ghidare	HS7601, HS7610, HS7611	1
	164367-1	Ghidaj paralel	N5900B	1
	1913J9-2	Opritor de reducere a reculului şinei de ghidare	/	1
	1913K5-7	Clemă de împingere a şinei de ghidare	/	1
	1913K7-3	Extensii ghidaj paralel	/	1

Suporturi pentru fierăstraie

	Cod	Descriere	Dimensiuni (L x l x H) (mm)	Pentru modelul	Ambalare (buc./set)
	194093-8	Masă pliantă		2704	1
	DEAWST05	Stand suport pentru fierăstraie	2.700 x 500 x 800/500	LS0714FB, LS1016, LS1018L, LS1019, LS1040F, LS1216, LS1440, LH1040, LH1200, MLS100, DLS211	1
	JM27000300	Masă pliantă cu roți		MLT100	1

Alte accesorii

	Cod	Descriere	Pentru modelul	Ambalare (buc./set)
	122538-6	Clemă fixare verticală	LS1013/F/L	1
	122563-7	Clemă fixare orizontală	DLS713, LS0714/FL, LH1040/F, LS1040/F, DLS211	1
	122707-9	Ghidaj paralel	LH1040/F, LS1040	1
	122446-1	Suport extensie masă	LH1040F, LS1040, LS1040F, LS1040FN	1
	122470-4	Menghină orizontală	DLS111, DLS211, LH1200FL, LH1201FL, LS1013, LS1013F, LS1013L, LS1016L, LS1214F, LS1214L, LS1018L, LS1019L, LS1219L	1
	122729-9	Ghidaj paralel	LF1000	1
	122730-4	Ghidaj unghiular	LF1000	1
	123104-2	Capac superior	LF1000	1
	122739-6	Ghidaj paralel	2704	1
	122740-1	Ghidaj paralel	2704	1
	122854-6	Clemă fixare verticală	LS1216L, LS1016L	1
	122930-6	Clemă orizontală	LS1216L, LS1018L	1
	123101-8	Ansamblu stator	LS1040/F, DLS713	1

	Cod	Descriere	Pentru modelul	Ambalare (buc./set)
	153896-9	Opritor drept auxiliar	LS1013/L/F, LS1214/F/L	1
	192625-5	Clemă fixare verticală	LH1040	1
	192628-9	Limitator (stânga și dreapta)	LS1013, LS1019/L, LS1214	2/1
	193730-1	Lampă fluorescentă, 5W	2107F, LS0714, LS1013, LS1040F, LS1214F	1
	194086-5	Prelungitor masă lateral	2704	1
	194087-3	Prelungitor masă posterior	2704	1
	194241-9	Ghidaj glisant	2704	1
	195253-5	Set opritor	LS1216L, DLS211	1
	JM21080290	Tijă împingere	LB1200F, LH1200FL	1
	JM23000127	Extensie masă	MLS100, LS0815	1
	JM23100500	Extensie masă	LS1018L, LH1200FL	1
	JM23610050	Bracheți montaj	WST06	2/1
	JM27000046	Extensie masă posterioară	MLT100	1
	JM27000202	Ghidaj paralel	MLT100X	1
	JM27000224	Ansamblu riglă unghiulară	MLT100X	1

ACCESORII PENTRU CAPSATOARE ȘI PISTOALE DE BĂTUT CUIE

Cuie în rolă inelate



Cuie în bandă de plastic



Cuie în bandă de hârtie



Mod foc cu foc



Mod foc cu foc/continuu



CUIE
Cuie în rolă pentru acoperiș

Cod	Diametru (mm)	Lungime totală (mm)	Înclinare (°)	Finisare	Pentru modelul	Ambalare (buc./set)
F-30791	3,1	38	16	galvanizat	AN450H	7.200/1

Role cuie pentru fixare în beton

Cod	Diametru (mm)	Lungime totală (mm)	Înclinare (°)	Finisare	Pentru modelul	Ambalare (buc./set)
F-33591	3	19	0	galvanizat	AN250HC	1.000/1

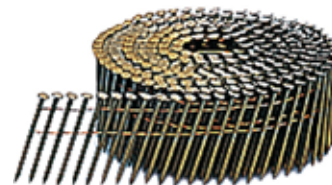
Role de cuie cu corp neted

Cod	Diametru (mm)	Lungime totală (mm)	Înclinare (°)	Finisare	Pentru modelul	Ambalare (buc./set)
F-30900	2,5	65	16	strat anticoroziv	AN621, AN901, AN902, AN610H, AN620H, AN711H, AN911H, AN960, AN961, AN635H, AN935H	8.100/1
F-31243	2,5	50	16	strat anticoroziv	AN621, AN901, AN902, AN610H, AN620H, AN711H, AN911H, AN960, AN961, AN635H, AN935H	10.800/1
F-30823	2,8	50	16	strat anticoroziv	AN621, AN901, AN902, AN610H, AN620H, AN711H, AN911H, AN960, AN961, AN635H, AN935H	9.000/1
F-30849	2,9	50	16	strat anticoroziv	AN621, AN901, AN902, AN610H, AN620H, AN711H, AN911H, AN960, AN961, AN635H, AN935H	9.000/1
F-30836	3,1	65	16	strat anticoroziv	AN621, AN901, AN902, AN610H, AN620H, AN711H, AN911H, AN960, AN961, AN635H, AN935H	6.750/1
F-31298	3,1	75	16	strat anticoroziv	AN621, AN901, AN902, AN610H, AN620H, AN711H, AN911H, AN960, AN961, AN635H, AN935H	4.050/1
F-31304	3,1	83	16	strat anticoroziv	AN621, AN901, AN902, AN610H, AN620H, AN711H, AN911H, AN960, AN961, AN635H, AN935H	4.050/1
F-31317	3,1	90	16	strat anticoroziv	AN621, AN901, AN902, AN610H, AN620H, AN711H, AN911H, AN960, AN961, AN635H, AN935H	4.050/1
F-30852	3,3	65	16	strat anticoroziv	AN621, AN901, AN902, AN610H, AN620H, AN711H, AN911H, AN960, AN961, AN635H, AN935H	4.050/1
F-31359	3,4	75	16	strat anticoroziv	AN621, AN901, AN902, AN610H, AN620H, AN711H, AN911H, AN960, AN961, AN635H, AN935H	3.600/1
F-31362	3,8	90	16	strat anticoroziv	AN621, AN901, AN902, AN610H, AN620H, AN711H, AN911H, AN960, AN961, AN635H, AN935H	2.700/1

Role cuie cu corp striat

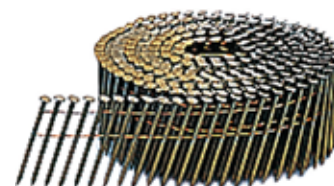

Cod	Diametru (mm)	Lungime totală (mm)	Înclinare (°)	Finisare	Pentru modelul	Ambalare (buc./set)
F-30865	2,5	50	16	strat anticoroziv	AN610H, AN620H, AN621, AN711H, AN901, AN902, AN911H, AN930H, AN960, AN961, AN935, AN635H	10.800/1
F-31269	2,5	65	16	strat anticoroziv	AN610H, AN620H, AN621, AN711H, AN901, AN902, AN911H, AN930H, AN960, AN961, AN935, AN635H	8.100/1
F-30881	2,9	65	16	strat anticoroziv	AN610H, AN620H, AN621, AN711H, AN901, AN902, AN911H, AN930H, AN960, AN961, AN935, AN635H	6.750/1
F-30971	2,9	50	16	strat anticoroziv	AN610H, AN620H, AN621, AN711H, AN901, AN902, AN911H, AN930H, AN960, AN961, AN935, AN635H	9.000/1
F-31272	2,9	57	16	strat anticoroziv	AN610H, AN620H, AN621, AN711H, AN901, AN902, AN911H, AN930H, AN960, AN961, AN935, AN635H	6.750/1
F-31285	2,9	71	16	strat anticoroziv	AN610H, AN620H, AN621, AN711H, AN901, AN902, AN911H, AN930H, AN960, AN961, AN935, AN635H	6.750/1
F-31333	3,1	85	16	strat anticoroziv	AN610H, AN620H, AN621, AN711H, AN901, AN902, AN911H, AN930H, AN960, AN961, AN935, AN635H	4.050/1
F-31320	3,2	75	16	strat anticoroziv	AN610H, AN620H, AN621, AN711H, AN901, AN902, AN911H, AN930H, AN960, AN961, AN935, AN635H	4.050/1
F-31346	3,2	90	16	strat anticoroziv	AN610H, AN620H, AN621, AN711H, AN901, AN902, AN911H, AN930H, AN960, AN961, AN935, AN635H	4.050/1

Role cuie cu corp neted



Cod	Diametru (mm)	Lungime totală (mm)	Înclinare (°)	Finisare	Pentru modelul	Ambalare (buc./set)
F-32766	2,1	32	16	strat anticoroziv	AN510H, AN560, AN610H	21.600/1
F-32779	2,1	38	16	strat anticoroziv	AN510H, AN560, AN610H	18.000/1
F-32782	2,1	45	16	strat anticoroziv	AN510H, AN560, AN610H	18.000/1
F-32795	2,1	50	16	strat anticoroziv	AN510H, AN560, AN610H	14.400/1

Role cuie cu corp striat



Cod	Diametru (mm)	Lungime totală (mm)	Înclinare (°)	Finisare	Pentru modelul	Ambalare (buc./set)
F-32801	2,1	38	16	strat anticoroziv	AN510H	18.000/1
F-32814	2,1	45	16	strat anticoroziv	AN510H	18.000/1
F-32827	2,1	50	16	strat anticoroziv	AN510H	14.400/1

Cuie netede (cap D) în bandă de hârtie



Cod	Diametru (mm)	Lungime totală (mm)	Înclinare (°)	Finisare	Pentru modelul	Ambalare (buc./set)
F-30579	3,1	75	34	fără strat protector	AN943	3.000/1
F-30601	3,1	83	34	fără strat protector	AN943	3.000/1

Cuie fără cap 18GA



Cod	Lungime totală (mm)	Finisare	Pentru modelul	Ambalare (buc./set)
F-31867	15	galvanizat	AF505, AF506, AF550H, DBN500, DFN350	5.000/1
F-31870	20	galvanizat	AF505, AF506, AF550H, DBN500, DFN350	5.000/1
F-31883	25	galvanizat	AF505, AF506, AF550H, DBN500, DFN350	5.000/1
F-31896	30	galvanizat	AF505, AF506, AF550H, DBN500, DFN350	5.000/1
F-31902	32	galvanizat	AF505, AF506	5.000/1
F-31915	35	galvanizat	AF505, AF506, AF550H, DBN500, DFN350	5.000/1
F-31928	38	galvanizat	AF505, AF506, AF550H, DBN500	5.000/1
F-31931	40	galvanizat	AF505, AF506, AF550H, DBN500	5.000/1
F-31944	45	galvanizat	AF505, AF506, AF550H, DBN500	5.000/1
F-31957	50	galvanizat	AF505, AF506, AF550H, DBN500	5.000/1
F-32946	55	galvanizat	AF550H	5.000/1

Cuie fără cap 23GA



Cod	Lungime totală (mm)	Finisare	Pentru modelul	Ambalare (buc./set)
F-31825	18	galvanizat	AF201Z, DPT351, DPT353, AF353	10.000/1
F-32142	18	inox	AF201Z, DPT351, DPT353, AF353	10.000/1
F-31838	25	galvanizat	AF201Z, DPT351, DPT353, AF353	10.000/1
F-32155	25	inox	AF201Z, DPT351, DPT353, AF353	10.000/1
F-31841	30	galvanizat	DPT351, DPT353, AF353	10.000/1
F-31854	35	galvanizat	DPT351, DPT353, AF353	10.000/1

CAPSE**Capse 16GA**

Cod	Lățime (mm)	Lungime totală (mm)	Finisare	Pentru modelul	Ambalare (buc./set)
P-75091	11	25	galvanizat	AT1150A	28.000/1
P-75138	11	40	galvanizat	AT1150A	14.000/1
F-32126	11	45	galvanizat	AT1150A	10.000/1

Capse 16GA

Cod	Lățime (mm)	Lungime totală (mm)	Finisare	Pentru modelul	Ambalare (buc./set)
F-32023	25	25	galvanizat	AT2550A	10.000/1
F-32036	25	32	galvanizat	AT2550A	10.000/1
F-32052	25	45	galvanizat	AT2550A	10.000/1

Capse 18GA

Cod	Lățime (mm)	Lungime totală (mm)	Finisare	Pentru modelul	Ambalare (buc./set)
F-33607	6,3	25	galvanizat	AT638	5.000/1
F-33636	6,3	32	galvanizat	AT638	5.000/1
F-33649	6,3	38	galvanizat	AT638	5.000/1

Cleme pentru capsatoare cu acumulatori

Cod	Lățime (mm)	Lungime totală (mm)	Grosime fir (mm)	Lățime (mm)	Pentru modelul	Ambalare (buc./set)
F-32904	10	6	0,6	1,2	DST221	5.040/1
F-81518	10	7	0,5	0,75	DST110, ST113D, DST112	2.500/1
F-32917	10	8	0,6	1,2	DST221	5.040/1
F-32647	10	10	0,6	1,2	DST220, DST221, T221D	5.040/1
F-81521	10	10	0,5	0,75	DST110, ST113D, DST112	2.500/1
F-32650	10	13	0,6	1,2	DST220, DST221, T221D	5.040/1
F-32663	10	16	0,6	1,2	DST220, DST221, T221D	5.040/1
F-32676	10	19	0,6	1,2	DST220, DST221, T221D	5.040/1
F-32689	10	22	0,6	1,2	DST220, DST221, T221D	5.040/1



ACCESORII PENTRU PISTOALE CU AER CALD



GAMA DE ACCESORII



1 Duză protecție sticlă

2 Duză lată

3 Duză reductoare

4 Duză reductoare suflantă



5 Duză de sudură

6 Duză de sudură rapidă

7 Duză de sudură

8 Duză de lipit



9 Rolă împingătoare

10 Șpaclu

11 Set șpaclu din 4 piese

12 Bare de lipit (PP, HDPE, ABS)



A Utilizare corectă
B Accesorii incluse la achiziție

ACCESORIU	COD	HG5012K	HG551VK	HG651CK	HG6030K	HG5030K	HG6031VK	HG6531CK
1 Duză protecție sticlă	P-33679	A / B	A	A	-	-	-	-
	PR00000028	-	-	-	A	A	A	A / B
2 Duză lată	P-33685	A / B	A / B	A / B	-	-	-	-
	PR00000029	-	-	-	A	A	A	A / B
3 Duză reductoare	P-71439	-	A / B	A / B	-	-	-	-
	PR00000031	-	-	-	A	A	A	A / B
4 Duză reductoare suflantă	P-71445	A / B	A / B	A / B	-	-	-	-
	PR00000030	-	-	-	A	A	A	A / B
5 Duză de sudură	P-71451	-	-	A	-	-	-	-
	PR00000034	-	-	-	A	A	A	A / B
6 Duză de sudură rapidă	P-71473	-	-	A	-	-	-	-
	PR00000039	-	-	-	A	A	A	A
7 Duză de sudură	P-71489	-	-	A / B	-	-	-	-
	PR00000032	-	-	-	A	A	A	A / B
8 Duză de lipit	P-56982	-	-	A	-	-	-	-
	PR00000033	-	-	-	A	A	A	A / B
9 Rolă împingătoare	P-71504	-	-	A / B	-	-	-	-
	PR00000035	-	-	-	A	A	A	A / B
10 Șpaclu	P-71548	A	A	A	-	-	-	-
	PR00000040	-	-	-	A	A	A	A
	PR00000042	-	-	-	A	A	A	A
11 Set șpaclu din 4 piese	P-71554	A	A	A	-	-	-	-
	PR00000041	-	-	-	A	A	A	A
12 Bare de lipit	P-71510	-	-	A	-	-	-	-
	PR00000038	-	-	-	-	-	-	A
	P-71526	-	-	A	-	-	-	-
	PR00000037	-	-	-	-	-	-	A
	P-71532	-	-	A	-	-	-	-
	PR00000036	-	-	-	-	-	-	A
Valiză		B	B	B	B	B	B	B

GAMĂ LARGĂ DE APLICAȚII



Vidare



Îndoire la cald



Contractare termică

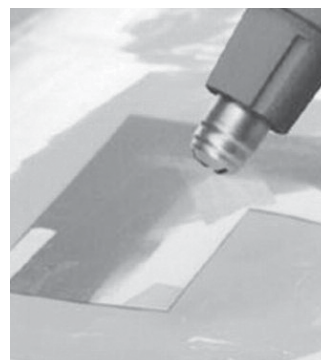

Uscare



Îndepărtare etichete



Reparații materiale plastice

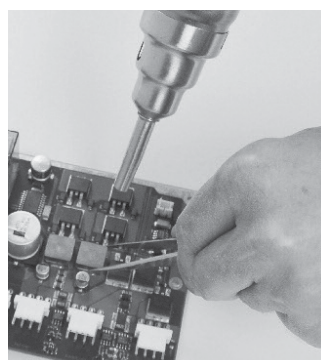

Reciclare



Uscare

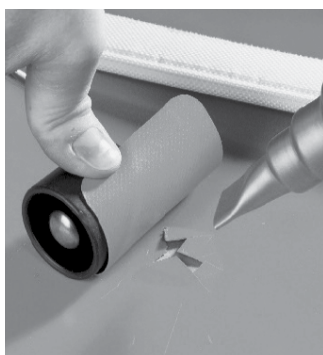

Aplicare plăsturi de sudură

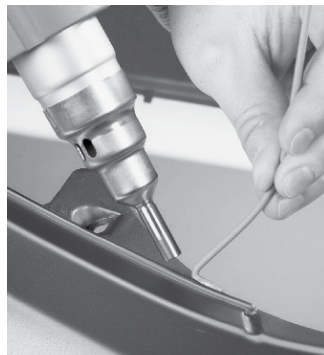

Sudare



Modelare

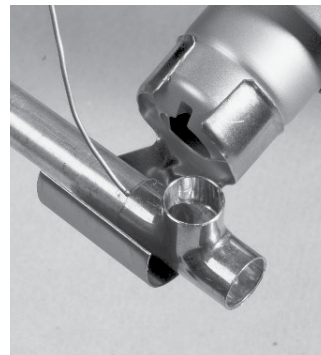

Lipire țevi cupru

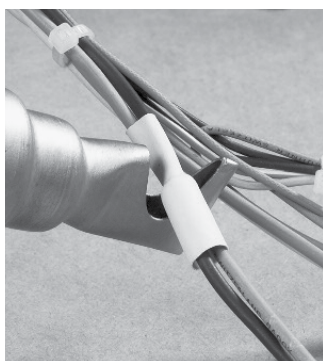

Contractare manșon izolant



Cântuire



Slăbire piulițe





Îndepărtare vopsea



Duze și alte accesorii

Makita oferă o gamă largă de accesorii pentru diferite tipuri de aplicații.

	Cod	Descriere	Lățime (mm)	Pentru modelul	Ambalare (buc./set)
	P-33679	Duză protecție sticlă	58	HG5012K, HG551VK, HG651CK	1
	PR00000028	Duză protecție sticlă	57	HG5030K, HG6030K, HG6031VK, HG6531CK	1
	PR00000029	Duză lată	57	HG5030K, HG6030K, HG6031VK, HG6531CK	1
	PR00000030	Duză deflectoare	62	HG5030K, HG6030K, HG6031VK, HG6531CK	1
	PR00000031	Duză de reducere	44	HG5030K, HG6030K, HG6031VK, HG6531CK	1
	PR00000032	Duză de sudură	80	HG5030K, HG6030K, HG6031VK, HG6531CK	1
	PR00000033	Duză de lipit	81	HG5030K, HG6030K, HG6031VK, HG6531CK	1
	PR00000034	Duză de sudură	65	HG5030K, HG6030K, HG6031VK, HG6531CK	1
	PR00000035	Rolă împingătoare	-	HG5030K, HG6030K, HG6031VK, HG6531CK	1
	PR00000039	Duză de sudură rapidă	52	HG5030K, HG6030K,	1

	Cod	Descriere	Lățime (mm)	Pentru modelul	Ambalare (buc./set)
	PR00000040	Răzuitor	-	HG5030K, HG6030K,	1
	PR00000041	Set de răzuire	-	HG5030K, HG6030K,	1
	PR00000042	Răzuitor	-	HG5030K, HG6030K,	1

Bare pentru lipit

	Cod	Descriere	Diametru (mm)	Lungime totală (mm)	Temperatură (°C)	Pentru modelul	Ambalare (buc./set)
	PR00000036	bară pentru lipit ABS	5	230	360	HG6531CK	1
	PR00000037	bară pentru lipit HDPE	5	230	300	HG6531CK	1
	PR00000038	bară pentru lipit PP	5	230	320	HG6531CK	1







ACCESORII MAȘINI PENTRU CURĂȚENIE ȘI ASPIRATOARE







Accesorii pentru mașina de frecat și lustruit PS001G

Perii 200 mm

Perie	Duritatea firelor	Utilizare	Cod
	Moale	Curățarea pardoselilor din lemn, terase / pontoane din lemn.	1914T0-6
	Medie	Pentru curățarea pardoselilor de interior.	1914T1-4
	Dură	Pentru curățarea pardoselilor exterioare din beton, îndepărtarea stratului de grăsimi din bucatării și zone similare.	1914T2-2
	Dură (cu abraziune)	Pentru curățarea gresiei / faianței porțelante și a suprafețelor similare.	1914T3-0



Paduri 190 mm

Pad	Culoare*1	Capacitate de curățare*2	Suprafață de curățat	Utilizare	Cod
	Alb	Moale ↑ ↓ Dură	Netedă ↑ ↓ Grosieră	Pentru lustruirea suprafețelor tratate cu rășină / ceară.	1914S5-9
	Roșu				1914S6-7
	Albastru			Pentru curățarea suprafețelor dure.	1914S7-5
	Maro			Pentru îndepărtarea rășinilor / decapare.	1914S8-3
	Negru				1914S9-1



*1 Cu cât culoarea este mai luminoasă / deschisă, cu atât granulația este mai fină; cu cât culoarea este mai închisă, cu atât granulația este mai grosieră (conform standardelor din industria de curățenie).

*2 Putere de îndepărtare a petelor și a cerii.

Support pentru pad

Support pentru paduri cu prindere tip scai.

Cod comandă:
1914S4-1

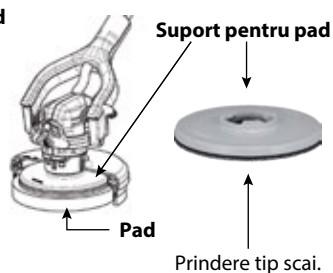

Geantă pentru accesorii

Geantă pentru accesorii fabricată din materiale rezistente la apă pentru transportul accesorilor umede. Capabilă să stocheze toate accesoriiile pentru acest model.

Cod comandă:
1915D1-8



Accesorii pentru mașina de măturat și aspirat VS001G

Adaptor multiplu

Cod comandă: 1913F5-2

- Cutiile MAKPAC (toate tipurile) pot fi instalate pentru depozitarea accesoriilor de curățare.
- Acumulatorii tip rucsac (PDC1200/1500) pot fi instalați pentru a crește timpul de lucru.



Sac de colectare

Cod comandă: 1913F7-8

- Capacitate: 47 L
- Potrivit pentru colectarea gunoaielor voluminoase cum ar fi frunzele căzute.
- Poate fi reutilizat.



Filtru HEPA

Cod comandă: 191D12-9



Prefiltru

Cod comandă: 162C89-5



Set perii valț

Cod comandă: 1830S5-9



Perie laterală

Cod comandă: 1830S6-7



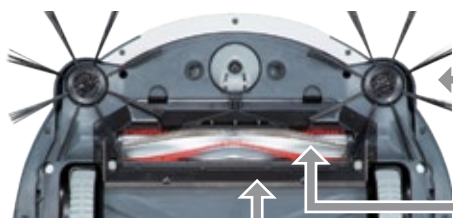

Accesorii pentru aspiratorul robot DRC300



Set perii laterale
 191P26-0 Set 2 perii Soft pentru suprafețe delicate
 191P28-6 Set 2 perii Standard (duritate medie)

Perie principală (rolă)
 191P20-2 Perie rolă Soft pentru suprafețe delicate
 191P22-8 Perie rolă Standard (duritate medie)

Soft 
 Standard 

Placă acoperire perie inferioară
 191P24-4

Bandă magnetică
 191P18-9
 5 m lungime, cu bandă dublu adezivă

Filtru HEPA
 191P31-7

HEPA filter 

Set bureți protecție
 191X35-7
 Se atașează la bara frontală pentru protecția obiectelor din jur, împotriva deteriorării



Filtre pentru aspiratoare cu acumulatori

Tip capsulă Modele: CL001G, DCL283F, DCL284F, DCL281F, DCL280F, DCL181F, DCL180F, DCL180, CL183D, CL111D, CL106FD, CL070D

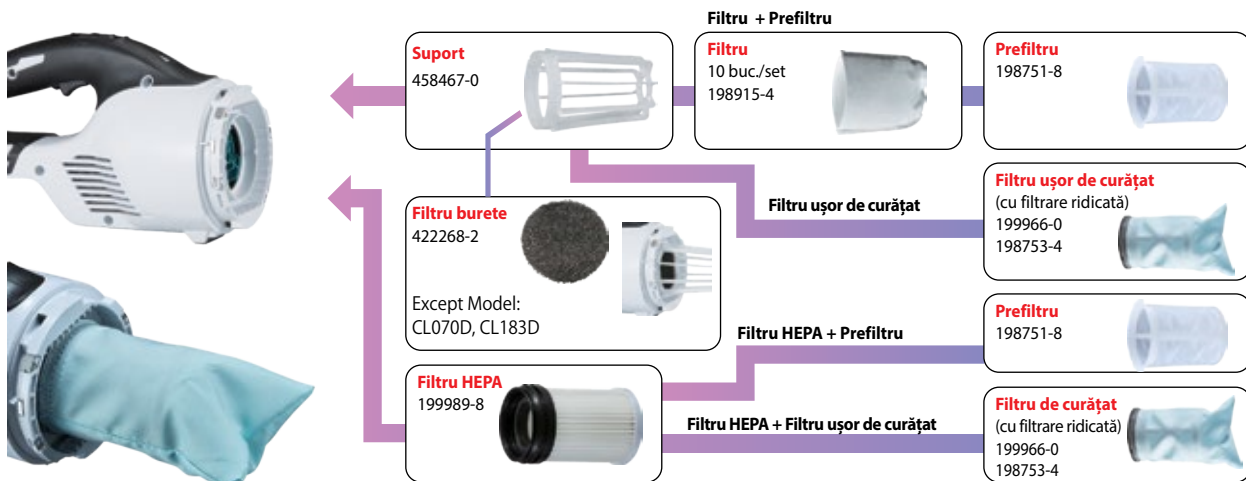

Tip Cyclon Modele: CL003G, DCL286F



Tip sac de hârtie Modele: CL002G, DCL285F, DCL282F, DCL182, DCL182F, CL121D, CL107FD, CL105D, CL104D, CL072D, CL121D

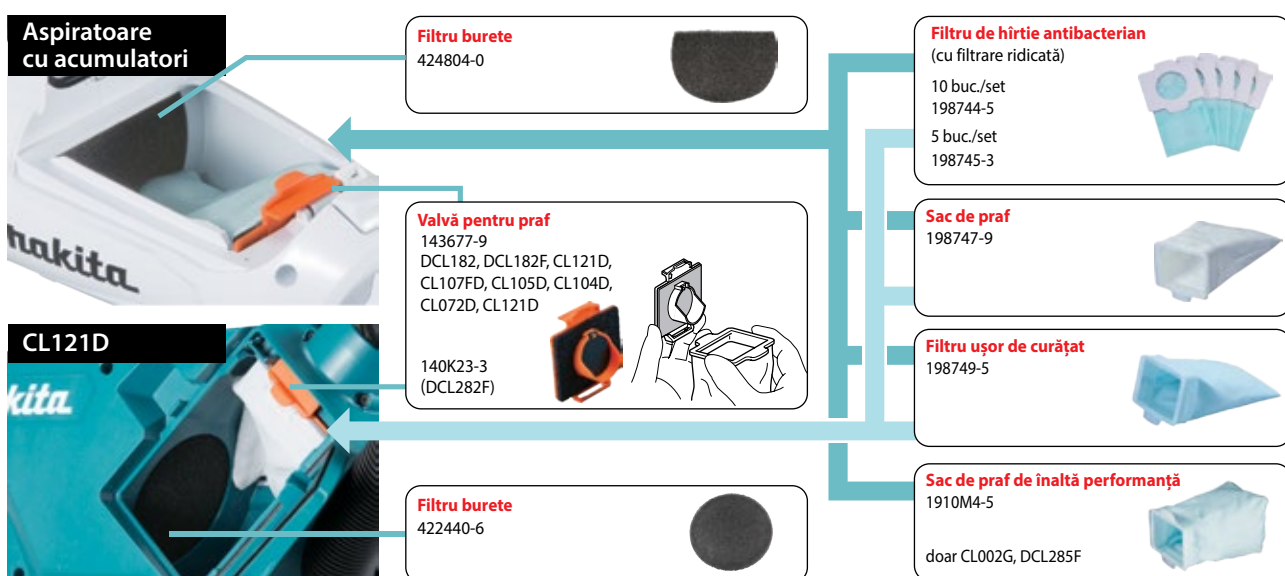

Filtre pentru aspiratoare portabile și aspiratoare tip rucsac

DVC750L

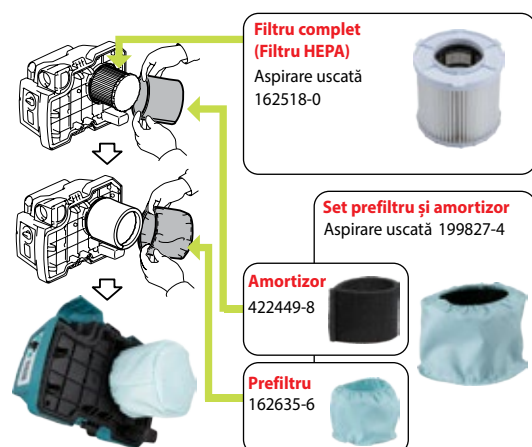

VC008G, VC009G, VC011G, VC012G, DVC261, DVC265, DVC660, DVC665

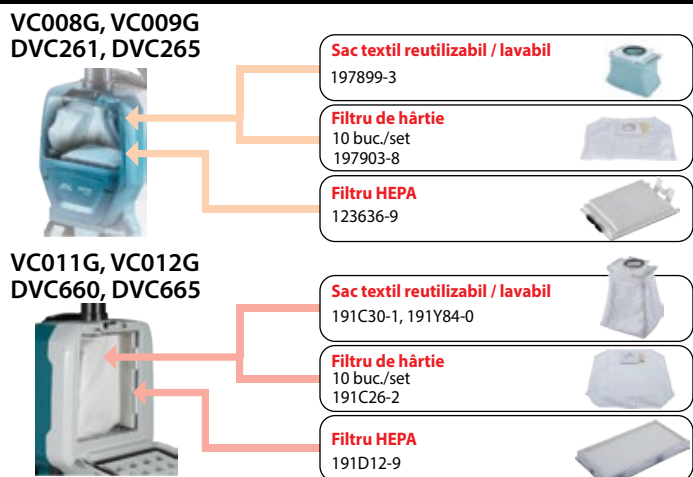

Furtunuri flexibile

	Cod	Descriere	Diametru (mm)	Lungime furtun (m)	Pentru modelul	Ambalare buc./set)
	197323-6	Suport furtun aspirare	/	/	DVC860L, VC3210L, VC3211H, C3211M	1
	P-81739	Furtun aspirare antistatic	32	3,5	VC2000L, VC2012L, VC2512L, VC3011L	1
	P-70487	Furtun aspirare antistatic	27	3,5	446L, 447L	1
	143787-2	Furtun flexibil	28	1	DVC260	1
	195433-3	Furtun flexibil	28	3,5	DVC860L, VC3210L, VC3211M, DVC862, DVC260, DVC150L	1
	191G76-1	Furtun flexibil cu plasă de nailon 28 mm-5 m	28	5	DVC150L, DVC151L, DVC152L, DVC153L, DVC154L, DVC860L, DVC861L, DVC862L, DVC863L, DVC864L, VC1310L, VC2201M, VC2211M, VC2510L, VC3210L, C3211H, VC3211M, XCV03, XCV04, XCV06, XCV07, XCV08, XCV13, XCV14, XCV15, XCV16	1
	198545-1	Furtun flexibil	32	0,45	CL070D, CL100D, CL104D, CL106FD, CL107FD, CL108FD, CL111D, DCL180, DCL280F, DCL281F	1
	198547-7	Furtun flexibil	32	0,45	CL070D, CL100D, CL104D, CL106FD, CL107FD, CL108FD, CL111D, DCL180, DCL280F, DCL281F	1
	199493-7	Furtun flexibil	32	1,7	DVC150L, DVC155L, DVC157L, DVC860L, DVC865L, DVC867L	1
	P-72914	Furtun flexibil	32	3,5	VC2010L, VC2511, VC3511L	1
	P-84084	Furtun flexibil antistatic	32	4	VC3012L, VC4210L/M	1
	P-72920	Furtun flexibil cu conexiune rapidă	36	3	446L, 447L	1
	195434-1	Furtun flexibil	38	2,5	DVC860L, VC3210L, VC3211M, DVC862, DVC260, DVC150L	1

	Cod	Descriere	Diametru (mm)	Lungime furtun (m)	Pentru modelul	Ambalare buc./set)
	140G04-3	Furtun	28	2	DVC750	1













Tuburi aspirare drepte și curbate



	Cod	Descriere	Pentru modelul	Ambalare buc./set)
	123584-2	Tub telescopic	VC3211, DVC260	1
	126756-8	Cot fără mecanism de blocare pentru țevi Ø28	DVC860, VC1310L, VC2510L, VC3210L, VC3211H, VC3211M	1
	458184-2	Cot fără mecanism de blocare pentru furtun Ø32/38	-	1
	140G26-3	Cot cu mecanism de blocare pentru furtun Ø32/38	-	1
	127093-3v	Cot cu mecanism de blocare pentru furtun Ø28	-	1
	191X62-4	Țeavă telescopică Ø32	-	1
	140G19-0	Țeavă telescopică din aluminiu, Ø28	VC008GZ, VC009, VC011, VC012, VC001, VC003, VC004, VC005	1
	192562-3	Tub curbat din aluminiu	DVC860, VC1310L, VC2510L, VC3210L, VC3211H, VC3211M, DVC150L	1
	192563-1	Tub curbat din aluminiu	DVC860, VC1310L, VC2510L, VC3210L, VC3211H, VC3211M, DVC150L	1
	199843-6	Tub aspirare din aluminiu	DVC260, DVC261, DVC265	1
	199844-4	Tub aspirare din aluminiu 32 mm	DVC260, DVC261, DVC265	1
	451244-9	Furtun aspirare	DCL140Z, DCL180Z, CL070DS, CL100DZ, CL100DZX	1
	459356-2	Tub drept cu atașament furtun	DCL280, DCL281	1
	P-70346	Furtun de mână, îndoit	446, 447L, 447MX, VC3012, VC4210	1
	P-72942	Tub prelungitor	VC2000L, VC2012L, VC2512L, VC3011L, VC2010L, VC3511L, 446L, 447L	1

Perii și alte accesorii pentru aspirare





	Cod	Descriere	Pentru modelul	Ambalare buc./set)
	122520-5	Duză pardoseală dură - uscat, 220 mm, ivory	4013D, 4033D, 4073D, 4093D	1
	122291-4	Duză covoare, 220 mm, ivory	Gama de aspiratoare Stick CL / DCL	1
	123485-4	Duză pardoseala dură - uscat, 220 mm, ivory	CL072, CL183	1
	123488-8	Duză pardoseala dură - uscat, 220 mm, albastră	CL106, CL107, CL108, DCL180, DCL181, DCL280, DCL281, DCL282, CL183	1
	127827-4	Duză pardoseala dură - uscat, 220 mm, albastră	CL001, CL002, CL003, DCL283, DCL284, DCL285, DCL286	1
	123539-7	Duză pardoseala dură - uscat, 220 mm, neagră	DCL180, DCL182, DCL280, DCL281	1
	123486-2	Duză pardoseala dură - uscat, 220 mm, albă	CL106, CL108, DCL180, DCL181, DCL280	1
	140H94-2	Perie moale lunga, rotire 360, albastră	CL121D	1
	191657-9	Perie rotundă	DVC860L, DVC862, DVC864, VC2510L, VC3210L, VC3211H, VC3211M	1
	191D73-9	Atașament Cyclon cu blocare țevă	CL001, CSL002, CL003, DCL280, DCL281, DCL282, DCL283, DCL284, DCL285, DCL286, VC008, VC011, VC001, VC003, VC004, VC005	1
	191D75-5	Atașament Cyclon	DCL180, DCL181, DCL182, CL183D, CL100D, CL102D, CL104D, CL105D, CL106D, CL107D, CL108D, CL111D	1
	192236-6	Tijă conică	DVC340, DVC350, DVC860L, VC3210L, VC3211H, VC3211M, DUB182, UB1100, DUB183, UB1103	1













	Cod	Descriere	Pentru modelul	Ambalare buc./set)
	191D65-8	Duză îngustă	DVC560, VC010	1
	195549-4	Duză perie pardoselă dură - uscat, 210 mm	VC006, VC007, VC3210L, VC3211LH, VC3211M, DVC860L, DVC862L, DVC864L	1
	195550-9	Duză pardoseală umedă, 210 mm	VC006, VC007, VC3210L, VC3211LH, VC3211M, DVC860L, DVC862L, DVC864L	1
	195551-7	Duză pardoselă dură, umed/uscat, 320 mm	VC006, VC007, VC3210L, VC3211LH, VC3211M, DVC860L, DVC862L, DVC864L, DVC150L	1
	197901-2	Duză flexibilă cauciuc 35 mm	DVC260, VC3211, DVC660, DVC260, DCL184	1
	198527-3	Duză covoare, 220 mm, albastră	DCL180, DCL501, CL070D, CL104D, CL106FD, CL107FD, CL111D, CL183D	1
	198528-1	Duză covoare, 220 mm, albă	DCL280F, DCL281F, DCL180, CL108FD, DCL181F, CL104D, CL183D, CL111D, CL106FD, CL100D, CL107FD, CL102D, CL070D, CL121D	1
	198532-0	Duză pardoseală combi, umed/uscată, 320 mm, Ø32, albă	VC001, VC003, VC004, VC005, VC011, VC012, VC008, VC009, țevi Ø28/32 mm	1
	198533-8	Duză pardoseală combi, umed/uscată, 320 mm, albă, Ø38	VC006, VC007, DVC350, DVC860L, DVC861, VC2211M, VC2510L, VC3210L, VC3211M, țevi Ø38 mm	1
	1914Y7-7	Duză cu perie rotativă Ø32	CL004G	1
	191G86-8	Duză combinată 320 mm, uscat/umed, Ø28	VC008, VC009, VC011, VC012, VC001, VC003, VC004, VC005	1
	1914Y6-9	Duză cu perie rotativă Ø28	CL004G	1

	Cod	Descriere	Pentru modelul	Ambalare buc./set)
	198538-8	Perie îngustă albastră	VC008, VC011, VC001, VC003, VC004, VC005, CL001, CL002, CL003, DCL282, DCL283, DCL284, DCL285, CL070D, CL100D, CL102D, CL104D, CL106D, CL183D, DCL180, DCL182, DVC260, DCL501, CL107FD, CL111D, DCL280F, DCL281F	1
	198540-1	Perie îngustă neagră	VC008, VC011, VC001, VC003, VC004, VC005, CL001, CL002, CL003, DCL282, DCL283, DCL284, DCL285, CL070D, CL100D, CL102D, CL104D, CL106D, CL183D, DCL180, DCL182, DVC260, DCL501, CL107FD, CL111D, DCL280F, DCL281F	1
	198553-2	Duză perie rotativă 360, scurtă, albastră	VC008, VC011, VC001, VC003, VC004, VC005, CL001, CL002, CL003, DCL282, DCL283, DCL284, DCL285, CL070D, CL100D, CL102D, CL104D, CL106D, CL183D, DCL180, DCL182, DVC260, DCL501, CL107FD, CL111D, DCL280F, DCL281F	1
	198555-8	Duză perie rotativă 360, scurtă, neagră	VC008, VC011, VC001, VC003, VC004, VC005, CL001, CL002, CL003, DCL282, DCL283, DCL284, DCL285, CL070D, CL100D, CL102D, CL104D, CL106D, CL183D, DCL180, DCL182, DVC260, DCL501, CL107FD, CL111D, DCL280F, DCL281F	1
	191D67-4	Duză perie rotativă 360, scurtă, albă	DVC560, VC010	1
	198990-0	Duză lungă spații înguste, albastră	VC008, VC011, VC001, VC003, VC004, VC005, CL001, CL002, CL003, DCL282, DCL283, DCL284, DCL285, CL070D, CL100D, CL102D, CL104D, CL106D, CL183D, DCL180, DCL182, DVC260, DCL501, CL107FD, CL111D, DCL280F, DCL281F	1
	198992-6	Duză lungă spații înguste, neagră	VC008, VC011, VC001, VC003, VC004, VC005, CL001, CL002, CL003, DCL282, DCL283, DCL284, DCL285, CL070D, CL100D, CL102D, CL104D, CL106D, CL183D, DCL180, DCL182, DVC260, DCL501, CL107FD, CL111D, DCL280F, DCL281F	1
	199039-9	Duză tapiserii 180 mm, neagră	VC008, VC011, VC001, VC003, VC004, VC005, CL001, CL002, CL003, DCL282, DCL283, DCL284, DCL285, CL070D, CL100D, CL102D, CL104D, CL106D, CL183D, DCL180, DCL182, DVC260, DCL501, CL107FD, CL111D, DCL280F, DCL281F	1
	199041-2	Duză tapiserii 180 mm, albastră	VC008, VC011, VC001, VC003, VC004, VC005, CL001, CL002, CL003, DCL282, DCL283, DCL284, DCL285, CL070D, CL100D, CL102D, CL104D, CL106D, CL183D, DCL180, DCL182, DVC260, DCL501, CL107FD, CL111D, DCL280F, DCL281F	1
	199486-4	Curea de umăr pentru transport DVC750	DVC750	1
	410306-2	Duză îngustă	VC006, VC007, DVC860, VC1310L, VC2510L, VC3210L, VC3211H, VC3211M, DVC150L	1
	451243-1	Duză îngustă scurtă	Aspiratoare Stick CL / DCL	1

	Cod	Descriere	Pentru modelul	Ambalare buc./set)
	459056-4	Duză covorașe auto 120 mm, albastră	VC008, VC011, VC001, VC003, VC004, VC005, CL001, CL002, CL003, DCL282, DCL283, DCL284, DCL285, CL070D, CL100D, CL102D, CL104D, CL106D, CL183D, DCL180, DCL182, DVC260, DCL501, CL107FD, CL111D, DCL280F, DCL281F, CL121, DCL184	1
	191M30-1	Duză cu perie 205 mm	VC008, VC011, VC001, VC003, VC004, VC005, CL001, CL002, CL003, DCL282, DCL283, DCL284, DCL285, CL070D, CL100D, CL102D, CL104D, CL106D, CL183D, DCL180, DCL182, DVC260, DCL501, CL107FD, CL111D, DCL280F, DCL281F, CL121, DCL184	1
	P-72958	Duză combinată pardoseală, umed/uscat, 360 mm	446L, 447L/M, VC2000L, VC2012L, VC2512L, VC3011L, VC3012L/M, VC4210M	1
	P-72964	Duză pardoseală dură umed/uscat, 400 mm, Ø35	446L, 447L, 447M, VC2010L, VC2512L, VC3011L, VC3012L, VC3012M, VC3511L, VC4210L, VC4210M	1
	W107402706	Perie pardoseală dură umed/uscat, 260 mm, Ø36mm	VC2000L, VC2012L, VC2512L, VC3011L	1
	W107417892	Duză combinată 280 mm, Ø36	446L, 447L/M, VC2000L, VC2012L, VC2512L, VC3011L, VC3012L/M, VC4210M	1
	W14295	Duză tapiserii, Ø36	446L, 447L/M, VC2000L, VC2012L, VC2512L, VC3011L, VC3012L/M, VC4210M	1
	W29541	Duză scurtă spații înguste, Ø36	446L, 447L/M, VC2000L, VC2012L, VC2512L, VC3011L, VC3012L/M, VC4210M	1













Filtre

	Cod	Descriere	Pentru modelul	Ambalare buc./set)
	1910N0-0	Filtru pentru apă	VC006G, VC007G	1
	1911B4-4	Burete prefiltru	VC006G, VC007G	1
	1911B5-2	Prefiltru textil	VC006G, VC007G	1
	1911B6-0	Filtru M	VC006G, VC007G	1
	1911B7-8	Filtru H	VC006G, VC007G	1

	Cod	Descriere	Pentru modelul	Ambalare buc./set)
	191V70-3	Filtru HEPA	VC001G, VC003G, VC004G, VC005G	1
	144625-1	Filtru textil	VC001G, VC003G, VC004G, VC005G	1
	191V71-1	Filtru textil	VC005GL	1
	1910C7-9	Filtru textil	CL001G, CL003G, DCL280F, DCL281F, DCL180, DCL181F	1
	140248-3	Filtru textil	DVC150L, DVC155L, DVC865L, DVC860L	1
	195441-4	Filtru	VC2510L, VC3210L	1
	195552-5	Filtru burete	DVC150L, DVC155L, DVC865L, DVC860L, DVC151L, DVC156L, DVC157L, DVC861L, DVC866L, DVC867L, VC3210L, VC2510L, VC1310L	1
	195553-3	Prefiltru	DVC860L, DVC151L, DVC156L,	1
	191V69-8	Prefiltru	VC003GL, VC005GL	1
	195555-9	Filtru aspirare umedă	DVC150L, DVC155L, DVC865L,	1
	195611-5	Filtru aspirare umedă	VC3210L	1
	195612-3	Prefiltru	VC3210L	1

	Cod	Descriere	Pentru modelul	Ambalare buc./set)
	196251-2	Filtru praf H	VC3211H	1
	196252-0	Filtru praf M	VC3211M, VC2211M, VC2201M	1
	196253-8	Prefiltru	VC3211H, VC3211M, VC2211M	1
	196254-6	Filtru burete	VC3211H, VC3211M, VC2211M, VC2201M	1
	199827-4	Set prefiltrare	DVC750	1
	199989-8	Filtru Hepa	DCL281F, DCL280F, DCL181F, DCL180F, DCL180, CL183D, CL111D, CL106FD	1
	1910C9-5	Filtru Hepa	CL001G, CL003G, DCL280F, DCL281F, DCL180, DCL181F	1
	443060-3	Filtru textil	DCL281F, DCL280F, DCL181F, DCL180F, DCL180, CL183D, CL111D, CL106FD, CL070D	1
	P-70219	Cartuș filtrant	446L, VC3012M, VC2012L, VC2512L, VC3011L, VC3012L, VC2000L	1
	P-70225	Cartuș filtrant	447L, 447M	1













Saci de praf

	Cod	Descriere	Pentru modelul	Ambalare buc./set)
	1910R3-2	Sac poly vinil	VC006GM, VC007GL	10/1
	195432-5	Sac plastic	VC001G, VC003G, VC004G, VC005G	10/1
	1910Y4-9	Sac filtrant "fleece" 35l	VC006GM, VC007GL	5/1
	1912R3-4	Sac filtrant "fleece" 7l	VC001G, VC005G	5/1
	194719-2 (A-49541)	Sac filtrant "fleece" 7l	DVC861L, DVC866L, DVC867L	5/1
	195557-5	Saci filtranti "fleece" 15l	VC003G, VC004G	5/1
	191T96-3	Sac textil	DVC560, VC010	10/1
	122918-6	Sac de praf	DVC340, DVC350	1
	191C26-2	Sac de praf	DVC660, DVC665	10/1
	191C30-1	Sac de praf	DVC660, DVC665	1/1
	195440-6	Sac de plastic	VC2510L, VC3210L, VC3211H, VC3211M, VC2211M	10/1
	195557-5	Sac de praf textil	DVC150L, DVC151L, DVC155L, DVC156L, DVC157L, DVC860L, DVC861L, DVC865L, DVC866L, DVC867L, VC1310L, VC2510L	5/1
	195558-3	Sac de praf textil	VC3210L, VC3211H, VC3211M, VC2211M	5/1

	Cod	Descriere	Pentru modelul	Ambalare buc./set)
	197899-3	Sac de praf textil	DVC260, DVC261, DVC265	1
	197903-8	Sac de praf de unică folosință	DVC260, DVC261, DVC265	10/1
	197898-5	Sac de praf textil	DVC260	1
	198747-9	Sac de praf	DCL282F, DCL182, DCL182F, CL121D, CL107FD, CL105D, CL104D, CL072D, CL121D	1
	198749-5	Sac de praf	DCL282F, DCL182, DCL182F, CL121D, CL107FD, CL105D, CL104D, CL072D, CL121D	1
	198753-4	Sac de praf, ușor de curățat	CL107DF, DCL181	1
	P-70194	Sac de praf de hârtie	446L	5/1
	P-70203	Sac de praf de hârtie	447L, 447M	5/1
	P-70297	Sac de praf de plastic	446L, VC2000L, VC2012L, VC2512L, VC3011L, VC3012L/M, VC2010L, VC2511, VC3511L	5/1
	P-70306	Sac de praf de plastic	447L, 447M	5/1
	P-72899	Sac de praf textil	VC2012L, VC2512L, VC3011L, VC2010L, VC2511, 446L	5/1
	P-78293	Sac de praf textil	VC3511L	5/1
	P-84078	Sac de praf textil	VC3012M / L, VC2512L, VC3011L	5/1
	W28547	Sac de praf de hârtie	443	5/1

Conectori pentru mașini electrice















	Cod	Descriere	Diametru interior (mm)	Diametru exterior (mm)	Pentru modelul	Ambalare (buc./set)
	122397-8	Duză de cuplare - aluminiu	70	-	1806B, KP312S	1
	122609-9	Ansamblu duză	-	-	RP0910, RP1110C	1
	122615-4	Duză cuplare în unghi	-	-	RP0910, RP1110C	1
	122652-8	Duză cuplare	19	22	9031, 9032	1
	126331-0	Ansamblu duză	-	-	DJV181, DJV182	1
	181575-9	Adaptor îmbinare furtun	-	-	1806B, KP312S	1
	191C20-4	Adaptor în unghi	-	-	DKP181, KP0810/C	1
	192420-3	Duză de praf	-	-	5603R, 5604R, 5703R, 5704R, 5705R	1
	192518-6	Duză de praf	32	38	9924DB	1
	192613-2	Adaptor aspirație	32	38	4105KB, 9401, PC1100	1
	193036-7	Capac aspirație / adaptor	-	-	2012NB	1
	194415-2	Duză praf	25	32	DSS500, DSS501	1



	Cod	Descriere	Diametru interior (mm)	Diametru exterior (mm)	Pentru modelul	Ambalare (buc./set)
	194733-8	Duză praf	35	38	RP0900, RT0700C, DRT50	1
	194934-8	Duză praf	35	38	RP1800FC, RP2300FCX	1
	195559-1	Duză praf	-	-	RT0700C, DRT50	1
	196520-1	Duză praf	-	-	DHS711, DHS710, HS7601	1
	196550-2	Duză praf	-	-	TM3010C	1
	196961-1	Duză praf	-	-	DHS680	1
	410899-9	Duză cuplaj	-	-	9741	1
	414468-8	Duză praf	-	-	1911B	1
	415426-7	Duză praf	32	38	5903R, 5103R	1
	415816-4	Duză praf	32	38	5143R	1
	416368-8	Cot de cuplaj	-	-	DKP180, LF1000, KP0810, KP0810C, KP0800	1
	416741-2	Duză praf	32	38	SG1251	1

	Cod	Descriere	Diametru interior (mm)	Diametru exterior (mm)	Pentru modelul	Ambalare (buc./set)
	419093-0	Adaptor îmbinare	43	52	2704, 2705	1
	419283-5	Duză aspirare praf	25	32	DSS610	1
	450079-5	Duză aspirare praf	35	38	5008MGA	1
	451329-1	Duză evacuare	-	-	KP0800, BKP180	1
	452091-1	Duză aspirare praf	-	-	MT582	1
	452237-9	Duză aspirare praf	-	-	HS300, HS301DZ	1
	166116-2	Curea de montare	-	-	DVC260, DVC3211, VC3211	1
	192349-3	Cuplaj de țevi	19,5/ 22	25	446L, 447L, VC2012L, VC2512L, VC3011L	1
	195544-4	Suport tijă 10-33	-	-	DVC860L, VC2510L, VC3210L, VC3211H, VC3211M	1
	195545-2	Conector frontal	38	44	DVC340, DVC350, DVC860L, VC3210L, VC3211H, VC3211M, VC2211, VC2512L	1
	195546-0	Conector frontal	24	35	DVC340, DVC350, DVC860L, VC3210L, VC3211H, VC3211M, VC2211, VC2512L	1
	195547-8	Conector frontal	22	25	DVC340, DVC350, DVC860L, VC3210L, VC3211H, VC3211M, VC2211, VC2512L	1

	Cod	Descriere	Diametru interior (mm)	Diametru exterior (mm)	Pentru modelul	Ambalare (buc./set)
	195548-6	Cuplaj țevi 22-38	22	38	DVC340, DVC350, DVC860L, VC3210L, VC3211H, VC3211M, VC2211	1
	414145-2	Adaptor cuplare	-	-	DVC340, DVC350	1
	417765-1	Conector frontal	-	-	DVC260, VC1310L, VC2510L, VC3210L	1
	50095B0N	Inel de reglare	-	-	440, 445X, 448, 449	1
	P-70378	Cuplaj rapid racordare conductă	25	38	446L/447L/447MX/VC3012L/VC3012M	1
	P-70384	Adaptor cuplare	-	-	446L, 447L	1
	P-70390	Cuplaj rotativ	52	60	446L, 447L	1
	P-70415	Cuplaj antistatic	25	38	446L, 447L	1
	P-70421	Adaptor antistatic	38	45	446L, 447L, VC2512L, VC3011L	1
	P-72936	Tube adaptor	25,5	35/ 38	VC4210L/M, VC3012L/M, VC2511, VC2512L, VC2012L, VC3011L	1
	P-81745	Adaptor cu reglare	25	36/ 38	VC2012L, VC2512, VC3011L	1
	W107418688	Adaptor	36/38	45	VC4210L/M, VC3012	1

Saci colectare praf pentru mașini electrice

	Cod	Descriere	Pentru modelul	Ambalare buc./set)
	122296-4	Sac de praf	9924DB, 9900B	1
	122297-2	Sac de praf	9401, 9402	1
	122548-3	Sac de praf	9910, 9911	1
	122562-9	Sac de praf	9403	1
	122591-2	Sac de praf	9404, 9920, 9903	1
	122708-7	Sac de praf	HR2432	1
	122793-0	Sac de praf	KP0810, KP0810C, KP0800, BKP180, DKP180	1
	122852-0	Sac de praf	DLS713, LS1016, LS1016L, LS1216, LS1216L, LH1040, LH1040F, LS1018, DLS211	1
	122853-8	Sac de praf	PC5000C, PC5001C	1
	123150-5	Sac de praf	PJ7000	1
	123328-0	Sac de praf	M9400	1
	135132-5	Sac de praf	MT941	1
	140686-9	Sac de praf	MT823	1
	135222-4	Sac de praf	BO4555, BO4556, BO4565, BO4566, MT924	1

	Cod	Descriere	Pentru modelul	Ambalare buc./set)
	135246-0	Suport filtru cu pungă de hârtie	DBO140, DBO180, BO4555, BO4556, BO4557, BO4558, BO4565, BO4566, BO5030, BO5031, BO5040, BO5041	1
	168557-8	Sac de praf	BO4565, BO4555, BO4557, BO3700, BO3710, BO3711, BO5030, BO5031, BO5041, BBO180	1
	191C21-2	Sac de praf	DKP181	1
	193293-7	Sac de praf din hârtie	9046, BO6030, BO5020, BO5021	5/1
	193294-5	Sac de praf din hârtie și suport	9046, BO3700, BO4900V, BO6030, BO5021	2/1
	193712-3	Sac de praf din hârtie	BO4553, BO4554, BO4561, BO4563, BO5011, BO5011, BO5012, BO5010, BO5011	5/1
	194746-9	Sac de hârtie	BO4565, BO4555, BO4557, BO3700, BO3710, BO3711, BO5030, BO5031, BO5041, BBO180	5/1
	196300-5	Sac de praf	1911B	1
	JM23100501	Sac de praf	LS1018L, LH1200FL	1
	122732-0	Sac de praf	LF1000	1

ACCESORII PENTRU MAȘINI DE GRĂDINĂ



CUȚITE PENTRU MAȘINI DE COSIT IARBA

PENTRU IARBĂ MICĂ	PENTRU IARBĂ ÎNALTĂ	PENTRU ARBUȘTI
<p>Cu 4 sau 2 dinți</p> <ul style="list-style-type: none"> ✓ Pentru iarbă groasă ✓ Recomandat pentru suprafețe mai mari 	<p>Cu 3 dinți</p> <ul style="list-style-type: none"> ✓ Pentru iarbă groasă, lăstăriș și arbuști. 	
		<p>Cu 40 de dinți</p> <ul style="list-style-type: none"> ✓ Pentru tufișuri, arbuști înalți și trunchiuri mai mici. ✓ Recomandat pentru mașini mai puternice

FIR NAILON ÎN FORMĂ DE TRIFOI CU PATRU FOI

NIVEL DE ZGOMOT REDUS ȘI EFICIENȚĂ MĂRITĂ

COMPARAȚIA FIRELOR

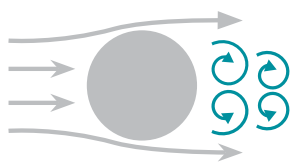

Forma rotundă opune rezistență ridicată la aer



Fir formă standard



Interior în formă de trifoi cu patru foi opune rezistență minimală la aer



Forma specială din patru părți creează un vârtej și reduce rezistența la aer, asigurând un nivel de zgomot redus și eficiență energetică mărită. Ideal pentru mașini cu acumulatori.

NIVEL DE ZGOMOT REDUS

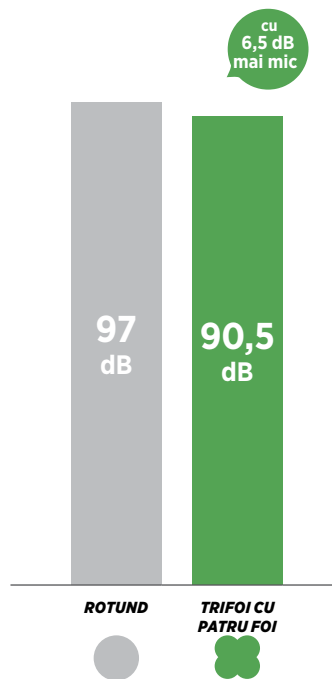









COD DE CULOARE

Diametru	Culoare
1,65 mm	
2,0 mm	
2,4 mm	
2,7 mm	



ACCESORII PENTRU MAȘINI DE COSIT IARBA

Cuțite

	Cod	Aplicație	Diametru (mm)	Grosime (mm)	Nr. dinți	Model compatibil	Ambalare (buc./set)
	198345-9 D-66064	iarbă înaltă	255	2,0	2	DUR369A/L, UR101C, UR201C	1
	195624-6	iarbă înaltă	305	2,0	2	EBH341L/U, EM4350LH/UH, EM4351UH	1
	D-66020	iarbă înaltă și groasă	230	3,0	3	DUR368A, DUR368L, DUR369A, DUR369L, EBH252U, EBH253U, EM2500U/L, EM2510LH, EM2511LH, EM2600U/L, EM2650LH/UH, EM2651LH/UH, EM2653LH, EM2654LH, UR101C, UR201C, EM400MP, EM401MP, EM402MP, EM403MP, EM404MP	1
	D-66036	iarbă înaltă și groasă	255	3,0	3	EBH340U/R, EBH341L/U/R, EM3400U/L, EM4350UH/LH/RH, EM4351UH, RBC411U, EBH340U, UR101C, UR201C, DUR182U, DUR191U	1
	D-66042	iarbă înaltă și groasă	305	3,0	3	EBH341L/U, EM4350LH/UH, EM4351UH	1
	D-66008	iarbă înaltă	230	1,8	4	DUR361U, DUR362U, DUR365U, DUR368A/L, DUR369A/L, UR101C, UR201C, EBH252U, EBH253U, EM2500U/L, EM2510LH, EM2511LH, EM2600U/L, EM2650LH/UH, EM2651LH/UH, EM2653LH, EM2654LH, EM400MP, EM401MP, EM402MP, EM403MP, EM404MP, EM401MP, EM402MP	1
	D-73324	iarbă groasă	230	1,8	8	DUR190; DUR191; DUR192; DUR194; DUR364; DUR365; DUR368; DUR369; R002GZ01; UR003G; UR006G; UR007G; UR012G; UR013GT; UR016G; UR017G; UR101C; UR201C; UR201G	
	196745-7	Pentru margini	203	2,5	2	EE2650H, EE400MP	1



Lame speciale și apărătoare

Pentru arbuști și copaci subțiri sau lăstari tineri.

Model	Lamă					Apărătoare			
	Diametru		Diametru interior	Grosime	Cod		Descriere	Diametru prindere	Cod
UR012G								28 mm	199873-7
UR013G	225 mm		25,4 mm	1,8 mm	199872-9		Fără clemă protectoare	25,4 mm	1911Y0-3
UR006G, DUR369A							Cu clemă protectoare	25,4 mm	1912L4-0









Lame de tocat





Pentru desiş și tufişuri dense.

Model	Lamă					Apărătoare			
	Diametru		Diametru interior	Grosime	Cod		Descriere	Diametru prindere	Cod
UR012G								28 mm	199875-3
UR013G	270 mm		25,4 mm	3,9 mm	199874-5		Fără clemă protectoare	25,4 mm	1911Y1-1

Capete cu fir

Pentru iarbă și buruieni mici.

	Cod	Descriere	Ref.	Dim.	Filet	Model compatibil	Fir	Ambalare (buc./set)
	198854-8	Bump & Feed		Bump & Feed	M8x1.25RH	UR100D	1.65 mm x 8 m	1
	198971-4	Bump & Feed	95-M8R	4"	M8x1.25RH	DUR189	2,0 mm x 3 m	1
	198893-8	Bump & Feed	95-M10L	4"	M10x1.25LH	DUR365U, DUR366L, DUR368A/L, DUR369A/L, EBH252U/L, EBH253U/L, EM2510LH, EM2511LH, EM2650UH/LH, EM2651UH/LH, EM2653LH, EM2654LH, UR101C, UR201C, UR202C, EM400MP, EM401MP, EM403MP, EM404MP, EM405MP, EM406MP	2,0 mm x 3 m	1
	197030-1	Bump & Feed	Bump & Feed ECO 6	6"	M10x1.25LH	EBH341U/L/R, EM4350UH/LH/RH, EM4351UH	3,0 mm x 3 m	1
	1914R6-0	Flat type	98-M10L	4"	M8x1.25LH M10x1.25LH	DUR369A, DUR369L, DUR369N, UR006G, UR007G, UR008G, UR101C, UR201C, UR202C	2,4 mm x 3 m	1
	1915D7-6	Flat type	98-M10L	4"	M10x1.25LH		2,4 mm x 3 m	1
	1914R8-6	Flat type	98-M10L	4"	M8x1.25LH M10x1.25LH	DUR190L, DUR190U, DUR191L, DUR191U, DUR192L, DUR194, DUR368A, DUR368L, DUR369A, DUR369L, DUR369N, UR002G, UR003G, UR006G, UR007G, UR008G, UR016G, UR017G, UR101C, UR201C, UR202C	2,0 mm x 3 m	1
	1915D8-4	Flat type	98-M10L	4"	M10x1.25LH		2,0 mm x 3 m	1

	Cod	Descriere	Ref.	Dim.	Filet	Model compatibil	Fir	Ambalare (buc./set)
	*B-02945	Utilizare automată Bump & Feed	Ultra Auto 4L	4"	M8x1.25LH M10x1.25LH	DUR187U/L, DU188U/L, EM2500U/L, EM2600U/L, EBH252U/L, EBH253U/L, EM2510LH, EM2511LH, EM2650UH/LH, EM2651UH/LH, EM2653LH, EM2654LH, EM400MP, EM401MP, EM403MP, EM404MP, EM405MP, EM406MP	2,4 mm x 3 m	1
	DA00000180	Tap & Go	-	4"	M8x1.25LH	DUR181, DUR182, DUR187	2,4 mm	1
	DA00000454	Tap & Go	-	4"	M8x1.25LH	DUR181, DUR182, DUR187	-	1
	195858-1	Cap cu un singur fir	-	4"	-	DUR181	-	1





Ureche 2 buc./set pentru Bump & Feed 4L/4R/Z5L, Ultra Auto 4R/4L/6L (A-15992)
*cu adaptor (ambalaj de plastic cu antet)

Cap cu un singur fir





	Cod	Model compatibil	Ambalare (buc./set)
	DA00000001	UR3000	1
	195858-1	DUR181	1
	191Y39-5	DUR193	1

Fire în formă de trifoi cu patru foi



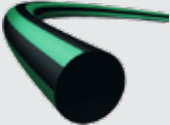
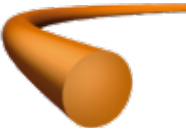



Corp spiralat

	Cod	Culoare	Diametru (mm)	Lungime (m)	Ambalare (buc./set)
	E-01731	Albastru	1,65	15	1
	E-01747	Albastru	1,65	30	1
	E-01753	Albastru	1,65	445	1
	E-01769	Verde	2,0	15	1
	E-01775	Verde	2,0	30	1
	E-01781	Verde	2,0	310	1
	E-01797	Portocaliu	2,4	15	1
	E-01806	Portocaliu	2,4	30	1
	E-01812	Portocaliu	2,4	225	1
	E-01828	Roșu	2,7	15	1
	E-01834	Roșu	2,7	30	1
	E-01840	Roșu	2,7	180	1



Fire

	Cod	Descriere	Diametru (mm)	Lungime (m)	Ambalare (buc./set)
	369224660	Fir silent	2,0	15	1
	369224670	Fir silent	2,4	15	1
	369224673	Fir silent	2,7	15	1
	369224674	Fir silent	3,0	15	1
	E-02727	Round trim	1,3	15	1
	E-02733	Round trim	1,6	15	1
	E-02705	Round trim	2,0	15	1
	E-02711	Round trim	2,0	126	1
	E-02749	Round trim +	2,4	15	1
	E-02761	Round trim +	2,4	87	1
	E-02783	Round trim +	2,4	262	1
	369224809	Round trim +	3,0	15	1
	369224810	Round trim +	3,3	15	1
	369224813	Round trim +	3,5	41	1
	369224814	Round trim +	4,0	30	1
	E-02808	Square trim +	2,4	15	1
	E-02814	Square trim +	2,4	69	1
	E-02820	Square trim +	2,4	206	1
	369224819	Square trim +	3,0	15	1
	369224820	Square trim +	3,3	15	1
	369224823	Square trim +	3,5	32	1
	369224824	Square trim +	4,0	25	1
	E-02836	Round trim PRO	3,0	15	1
	E-02870	Square trim PRO	3,0	15	1



Lame de plastic

	Cod	Descriere	Diametru cosire (mm)	Filet	Model compatibil	Ambalare (buc./set)
	198848-3	Cap cu o lamă de plastic	230	M8x1.25RH	UR100D	1
	198850-6 198851-4	Lamă de schimb pentru 198848-3	-	-	UR100D	5
	198383-1	Cap cu 3 lame de plastic	255	M8x1.25RH M8x1.25LH M10x1.25LH	DUR187L/U, DUR188L/U, DUR189, DUR364L, DUR365U, DUR366L, DUR368A/L, DUR369A/L/N, UR101C, UR201C, EM403MP, EM404MP, EM405MP, EM406MP	1
	198426-9	Lamă de schimb pentru 198383-1	-		DUR187L/U, DUR188L/U, DUR189, DUR364L, DUR365U, DUR366L, DUR368A/L, DUR369A/L/N, UR101C, UR201C, EM403MP, EM404MP, EM405MP, EM406MP	12
	199868-0	Cap cu 3 lame de plastic	255	M10x1.25LH	DUR369A/L/N, UR101C, UR201C	1
	199870-3	Lamă de schimb pentru 199868-0	-		DUR369A/L/N, UR101C, UR201C	12

Curea de umăr și ham

	Cod	Descriere	Model compatibil	Ambalare (buc./set)
	125516-5	Curea de umăr	DUR181, DUR184L, DUR187L, DUR188L, DUR189, DUR364L, DUR365U, UR100D, UR180D, UR201C, DUR366L, DUX60, EBH252L, EBH253L, EBH341L, EM2510LH, EM2511LH, EM2650LH, EM2651LH, EM2653LH, EM2654LH, EM3400L, EN4950H, EN4951SH, EY2650H, EX2650LH, RBC411U, RBC412U	1
	122906-3	Ham	DUR369A, UR101C, EBH252U, EBH253U, EBH341U, EM2650UH, EM2651UH, EM4350UH, RBC411U, RBC412U, RBC413U, RBC414U	1

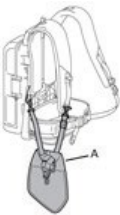
Curele pentru PDC01 și PDC1200

	Cod	Tip	Ambalare (buc./set)
	191E43-4	A	1
	197243-4	B	1

ACCESORII PENTRU MAȘINI MULTIFUNȚIONALE

	Cod	Descriere	Model compatibil	Ambalare (buc./set)
	EM400MP 191A17-1	Coasă Diametru cosire: 420 mm Filet: M10 x 1.25LH	EX2650LH	1
	ER400MP 198314-0	Trimmer Diametru cosire: 410mm Filet: M8 x 1.25RH	EX2650LH	1
	EM401MP 195888-2	Coasă Diametru cosire: 300 mm Filet: M10 x 1.25LH	DUX18, DUX60, EX2650LH, UX01G	1
	EM404MP 198942-1	Coasă Diametru cosire: 450 mm Filet: M10 x 1.25LH	DUX60, UX01G	1
	EM407MP Z87707	Foarfecă rotativă Diametru cosire: 230 mm	DUX60, EX2650LH	1
	EY401MP 191T38-7 199926-2	Fierăstrău emondor Lungime lamă: 25cm Lanț: 91VXL-39links	DUX18, DUX60, EX2650LH, UX01G	1
	UB402MP 1912R8-4	Suflantă	DUX18, DUX60, EX2650LH, UX01G	1
	UB401MP 191P76-5	Suflantă cu amortizor de zgomot	DUX18, DUX60, EX2650LH, UX01G	1
	EN401MP 196257-0	Foarfecă pentru gard viu Unghi reglabil	DUX18, DUX60, EX2650LH, UX01G	1
	EN410MP 197743-4	Foarfecă pentru gard viu Unghi fix	DUX18, DUX60, EX2650LH, UX01G	1
	EN420MP 198062-1	Foarfecă cosit iarba	DUX18, DUX60, EX2650LH, UX01G	1

	Cod	Descriere	Model compatibil	Ambalare (buc./set)
	EN422MP 1912T0-4	Foarfecă cosit iarba groasă	DUX18, DUX60, UX01G	1
	EN424MP 1913E2-1	Foarfecă cosit iarba groasă	DUX18, DUX60, UX01G	1
	WA400MP 1913P8-6	Accesoriu de plivit Lățime de lucru: 200 mm	DUX18, DUX60, UX01G	1
	PF400MP	Pompă apă UX01G - 135 L/min; DUX60 - 125 L/min; DUX18 - 100 L/min	DUX18, DUX60, UX01G	1
	KR401MP 199183-2	Cultivator Lățime de lucru: 220 mm	DUX18, DUX60, EX2650LH, UX01G	1
	SN400MP	Freză de zăpadă	DUX18, DUX60, UX01G	1
	BR400MP 199320-8	Perie măturătoare	DUX18, DUX60, EX2650LH, UX01G	1
	SW400MP 199341-0	Valț măturător	DUX18, DUX60, EX2650LH, UX01G	1
	EJ400MP 195721-8	Accesoriu recoltare cafea	DUX18, DUX60, EX2650LH, UX01G	1
	EE400MP 196753-8	Delimitator gazon	DUX18, DUX60, EX2650LH, UX01G	1
	LE400MP 196032-4	Tijă prelungitoare Compatibilă cu fierăstrău emondor, foarfecă pentru gard viu și accesoriu recoltare cafea	DUX18, DUX60, EX2650LH, UX01G	1

ACCESORII PENTRU MAȘINI DE TUNS GAZON
Cuțite

Cod	Dimensiune (mm)	Model compatibil	Ambalare (buc./set)
Mașini de tuns gazon cu acumulatori			
GB00000042	330	DLM330	1
191D41-2	380	DLM382	1
191D41-2	380	DLM380	1
1913H0-6	380	LM003G	1
197761-2	430	DLM431	1
191D43-8	430	DLM432	1
1913H4-8 / 1913H6-4**	430	LM004G	1
199367-2	460	DML460	1
191W86-4* / 191D51-9 / 199367-2	460	DLM462	1
191V97-3 / 191Y64-6**	480	DLM480, DLM481, LM001G, LM001J, LM003J	1
191D52-7	530	DLM530, DLM531, DLM532, DLM533, DLM534, DLM535, DLM536, DLM537, LM001C	1
191V96-5	530	DLM538, DLM539, LM002G, LM002J, LM004J	1
191W87-2* / 191Y65-4**	530	DLM530, DLM532, DLM533, DLM534, DLM536, DLM537, DLM538, DLM539, LM001C, LM002G, LM002J, LM004J	1
Mașini de tuns gazon cu motor electric			
YA00000745	330	ELM3320	1
YA00000746	370	ELM3720	1
YA00000747	410	ELM4120	1
YA00000738	410	ELM4121	1
YA00000741	460	ELM4620, ELM4621	1

Cod	Dimensiune (mm)	Model compatibil	Ambalare (buc./set)
Mașini de tuns gazon cu motor termic			
671001433	410	PLM4120N	1
DA00001274	460	PLM4620N2, PLM4621N2, PLM4622N2, PLM4626N, PLM4627N, PLM4628N, PLM4630N2, PLM4631N2, PLM4632N	1
DA00001276	510	PLM5130N	1
DA00000973	510	PLM5113N2	1
DA00001275	560	PLM5600N2	1







*High flow blade for better grass catching **Mulching blade used without grass catcher



Accesorii pentru mulcire

Cod	Model compatibil	Ambalare (buc./set)
413945-7	DLM538, DLM539, LM002J	1
413946-5	DLM480, DLM481, LM001J	1

Tamburi pentru scarificatoare

	Cod	Tip	Model compatibil	Ambalare (buc./set)
	1913J5-0	Scarificare	UV001G	1
	1913J7-6	Greblare	UV001G	1
	652024718	Scarificare	UV3200, DUV320	1
	652024719v	Greblare	UV3200, DUV320	1
	652024746	Scarificare	UV3600	1
	652024750	Greblare	UV3600	1
	652024749	Combinat	UV3600	1

ACCESORII PENTRU FIERĂSTRAIE CU LANȚ

Lamă și lanț

B Adâncime tăiere



C Pas lanț



D Dinte lanț



E Grosime

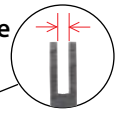

F Tip tăiere



A Lungime lamă



A Lungime lamă

Lungimea lamei de ghidare reprezintă lungimea efectivă de tăiere care este diferită de lungimea totală a lamei.



D Dinte lanț

Lungimea lanțului este determinată prin numărarea numărului de legături ale acestuia.

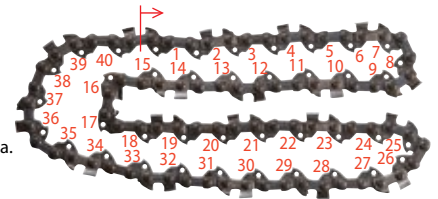

B Adâncime de tăiere

Adâncimea de tăiere reprezintă distanța dintre vârful dintelui de tăiere și vârful limitatorului de adâncime, aceasta determinând adâncimea de tăiere în lemn.



C Pas lanț

Pasul lanțului este definit ca distanța dintre oricare trei nuri consecutive împărțit la doi. Pasul este important deoarece unitatea de transmisie trebuie să aibă același pas ca lanțul.



E Grosime

Grosimea este dată de grosimea unităților de ghidare ale lanțului. Foarte important, atât lanțul cât și lama împreună cu roata de transmisie trebuie să fie compatibile.

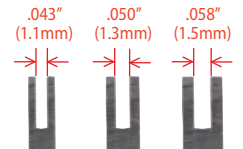

F Tip tăiere

Tip tăiere	MICRO CHISEL	SEMI CHISEL	CHAMFER CHISEL	FULL CHISEL
Prescurtare	MC	SC	CC	FC
Imagine				

Lamă cu vârf circular

Lamă cu vârf circular

Lamele de acest tip au montat în vârf un pinion dințat. Rolul acestuia este de a face trecerea lină și de a reduce frecarea.



Solid Bar

Lamele de tip solid bar sunt destinate situațiilor dificile, inclusiv incendiilor de pădure sau deșert.



Lamă sculptură

Lama pentru sculptură este fabricată din oțel de înaltă calitate iar vârful este sudat de lamă. Vârful subțire este proiectat pentru tăieri de precizie. Lamele de acest tip sunt destinate în special pentru sculptură și toaletarea pomilor fructiferi.



Mentenanță lamă

Tensionarea lanțului

Perioadic este necesară întinderea lanțului. Lanțul se poate slăbi după câteva ore de utilizare.



Canturile lamei

Utilizați pila lată o dată pe săptămână pentru întreținerea canturilor lamei și a le menține la 90°.



Curățarea lamei

Curățați canalul de ghidare al lamei la fiecare ascuțire a lanțului sau la înlocuirea acestuia.

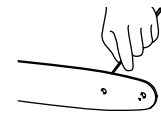

Ungerea vârfului circular

Ungeți regulat întregul pinion circular pentru a asigura o frecare minimă.

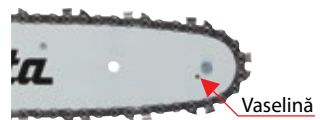

Ascuțirea lanțului

Pila rotundă și suportul de pilă



Pila poate fi utilizată mult mai ușor dacă este utilizat un suport de pilă. Suportul de pilă a fost creat pentru ca ascuțirea corectă la unghi de 30° (alineați marcasele paralel cu lanțul).

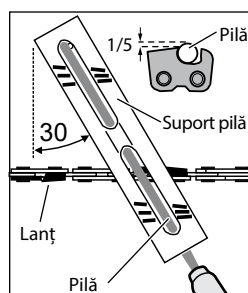

Limitator de adâncime

După ascuțirea lanțului, verificați adâncimea de tăiere a lanțului utilizând lera.

Pilă lată

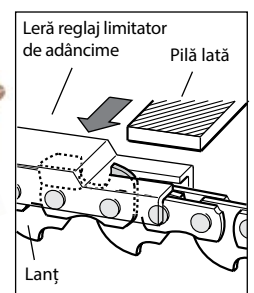

Lame / lanțuri / apărători / roți de transmisie

Tip tăiere: CC: Chamfer chisel, SC: Semi chisel, MC : Micro chisel, FC: Full chisel.





Cod	Lamă					Lanț						Teacă	Roată de transmisie	
	Lungime lamă	Motor	Tip	Dinți vârf circulant	Cod comandă	Număr dinți	Grosime	Pas	Tip OREGON / DOLMAR	Tip tăiere	Cod comandă (cutie carton)	Cod comandă	Tip	Cod comandă
DUC101 UC100D	10 cm	-	Fără vârf circulant	-	1910W0-3	26	1,1 mm	.325"	80TXL	MC	1910V6-4	413M40-1	.325" LP	1911W5-9
DUC150 UC029G	15 cm	-	Fără vârf circulant	-	1912F1-4	32	1,1 mm	.325"	80TXL	MC	1912E8-3	413T67-3	.325" LP	1911W5-9
DUC122	16cm	-	Fără vârf circulant	-	158476-6	42	1,3 mm	1/4"	25AP / 466	MC	191G95-7	416311-7	Roată 1/4"	221527-9
DUC254 DUC254C	25cm	-	Lamă sculptură	-	168407-7	60	1,3 mm	1/4"	25AP / 466	MC	191G96-5	452093-7	Roată 1/4"	198259-2
	25cm	A041	Vârf circulant	7	191G14-3	40	1,1 mm	3/8" LP	90PX / 291	CC	191H00-0	452093-7	Roată 3/8" LP	199063-2
	25cm	A041		7	191G18-5	40	1,3 mm	3/8" LP	91PX / 492	CC	191H08-4	452093-7		
DUC302	25cm	-	Lamă sculptură	-	168407-7	60	1,3 mm	1/4"	25AP / 466	MC	191G96-5	452093-7	Roată 1/4"	221528-7
	25cm	A041	Vârf circulant	7	191G15-1	40	1,1 mm	3/8" LP	90PX / 291	CC	191H00-0	452093-7	Roată 3/8" LP	221526-1
	30 cm	A041		7	191G16-9	46				CC	191H01-8	419288-5		
	35 cm	A041		7	191G17-7	52				CC	191H02-6	419288-5		
	25cm	A041		7	191G23-2	40	1,3 mm	3/8" LP	91PX / 492	CC	191H08-4	452093-7		
	30 cm	A041		7	191G24-0	46				CC	191H10-7	419288-5		
	35 cm	A041		7	191G25-8	52				191H11-5	419288-5			
35 cm	A041	7		191G25-8	52	191H11-5				419288-5				
DUC256 DUC306 DUC356 DUC406 DUC256C	25cm	-	Lamă sculptură	-	168407-7	60	1,3 mm	1/4"	25AP / 466	MC	191G96-5	452093-7	Roată 1/4"	198259-2
	25cm	A041	Vârf circulant	7	191G14-3	40	1,1 mm	3/8" LP	90PX / 291	CC	191H00-0	452093-7	Roată 3/8" LP	199063-2
	30 cm	A041		7	191G15-1	46				CC	191H01-8	419288-5		
	35 cm	A041		7	191G16-9	52	191H02-6	419288-5						
	40 cm	A041		7	191G17-7	56	191H03-4	419242-9						
	25cm	A041		7	191G22-4	40	1,3 mm	3/8" LP	91PX / 492	CC	191H08-4	452093-7		
	30 cm	A041		7	191G23-2	46				191H10-7	419228-5			
	35 cm	A041		7	191G24-0	52				191H11-5	419288-5			
40 cm	A041	7		191G25-8	56	191H12-3				419242-9				
DUC353, DUC355	30 cm	A041	Vârf circulant	7	191G15-1	46	1,1 mm	3/8" LP	90PX / 291	CC	191H01-8	419288-5	Roată 3/8" LP	199063-2
	35 cm	A041		7	191G16-9	52				CC	191H02-6	419288-5		
	40 cm	A041		7	191G17-7	56	191H03-4	419242-9						
	30 cm	A041		7	191G23-2	46	1,3 mm	3/8" LP	91PX / 492	CC	191H10-7	419228-5		
	35 cm	A041		7	191G24-0	52				191H11-5	419288-5			
	40 cm	A041		7	191G25-8	56				191H12-3	419242-9			
40 cm	A041	7	191G25-8	56	191H12-3	419242-9								
UC3541A, UC4041A	30 cm	A041	Vârf circulant	7	191G15-1	46	1,1 mm	3/8"	90PX / 291	CC	191H01-8	419288-5	Roată 3/8" LP	221526-1
	35 cm	A041		7	191G16-9	52				CC	191H02-6	419288-5		
	40 cm	A041		7	191G17-7	56	191H03-4	419242-9						
	30 cm	A041		7	191G23-2	46	1,3 mm	3/8"	91PX / 492	CC	191H10-7	419288-5		
	35 cm	A041		7	191G24-0	52				191H11-5	419288-5			
	40 cm	A041		7	191G25-8	56				191H12-3	419242-9			
40 cm	A041	7	191G25-8	56	191H12-3	419242-9								
UC3550A, UC4050A, UC3551A, UC4051A	30 cm	A041	Vârf circulant	7	191G23-2	46	1,3 mm	3/8"	91PX / 492	CC	191H10-7	419288-5	Roată 3/8" LP	221521-1
EY2650H, EY401MP 196315-2*	25 cm	A218	Vârf circulant	7	191G11-9	39	1,3 mm	3/8" LP	91VXL / 196	SC	191H20-4	452093-7	Roată 3/8" LP	XTM000014

Cod	Lamă					Lanț						Teacă	Roată de transmisie	
	Lungime lamă	Motor	Tip	Dinți vârf circulant	Cod comandă	Număr dinți	Grosime	Pas	Tip OREGON / DOLMAR	Tip tăiere	Cod comandă (cutie carton)	Cod comandă	Tip	Cod comandă
EA3110T	25 cm	A041	Vârf circulant	7	191G22-4	40	1,3 mm	3/8" LP	91PX / 492	CC	191H08-4	452093-7	Ambreiaj 3/8" LP	MR00286238
	30 cm	A041		7	191G23-2	46					191H10-7	419561-3		
EY402MP EY403MP DUA250 DUA251 DUA300 DUA301 UA003G UA004G	25 cm	A041	Vârf circulant	7	191G14-3	40	1,1 mm	3/8"	90PX	CC	191H00-0	452093-7 / 458501-6	3/8" LP	226992-7
	30 cm	A041		7	191G15-1	46					191H01-8	419288-5 / 413G23-5		
	25 cm	A041		7	191G22-4	40	1,3 mm		91PX	CC	191H08-4	452093-7 / 458501-6		
	30 cm	A041		7	191G23-2	46					191H10-7	419288-5 / 413G23-5		
UC022G UC026G	40 cm	A041	Vârf circulant	7	191T88-2	56	1,1 mm	.325"	80TXL	MC	191T92-1	419242-9 / 413G21-9	Roată .325" LP	191V91-5
	30 cm	A041	Vârf circulant	6	191G15-1	46	1,1 mm	3/8"	90PX	CC	191H01-8	419288-5 / 413G23-5	Roată 3/8" LP	191V90-7
	35 cm	A041		6	191G16-9	52					191H02-6	419288-5 / 413G23-5		
	40 cm	A041		6	191G17-7	56					191H03-4	419242-9 / 413G21-9		
	30 cm	A041	Vârf circulant	6	191G23-2	46	1,3 mm	3/8"	91PX	CC	191H10-7	419288-5 / 413G23-5		
	35 cm	A041		6	191G24-0	52					191H11-5	419288-5 / 413G23-5		
	40 cm	A041		6	191G25-8	56					191H12-3	419242-9 / 413G21-9		
DUC357	30 cm	A041	Vârf circulant	7	191G15-1	46	1,1 mm	3/8"	90PX	CC	191H01-8	419288-5 / 413G23-5	Roată 3/8" LP	199063-2
	35 cm	A041		7	191G16-9	52					191H02-6	419288-5 / 413G23-5		
	40 cm	A041		7	191G17-7	56					191H03-4	419242-9 / 413G21-9		
	30 cm	A041	Vârf circulant	7	191G23-2	46	1,3 mm	3/8"	91PX	CC	191H10-7	419288-5 / 413G23-5		
	35 cm	A041		7	191G24-0	52					191H11-5	419288-5 / 413G23-5		
	40 cm	A041		7	191G25-8	56					191H12-3	419242-9 / 413G21-9		
UC003G UC004G UC006G	25 cm	-	Lamă sculptură	9	1911A1-3	60	1,3 mm	1/4"	25AP	MC	191G96-5	452093-7 / 458501-6	Roată 1/4"	191V92-3
	25 cm	A041	Vârf circulant	7	191T85-8	46	1,1 mm	.325"	80TXL	MC	191T89-0	452093-7 / 458501-6	Roată .325" LP	191V91-5
	30 cm	A041		7	191T86-6	51					191T90-5	419288-5 / 413G23-5		
	35 cm	A041		7	191T87-4	59					191T91-3	419288-5 / 413G23-5		
	25 cm	A041	Vârf circulant	7	191G14-3	40	1,1 mm	3/8"	90PX	CC	191H00-0	452093-7 / 458501-6	Roată 3/8" LP	191V90-7
	30 cm	A041		7	191G15-1	46					191H01-8	419288-5 / 413G23-5		
	35 cm	A041		7	191G16-9	52					191H02-6	419288-5 / 413G23-5		
	25 cm	A041	Vârf circulant	7	191G22-4	40	1,3 mm	3/8"	91PX	CC	191H08-4	452093-7 / 458501-6		
	30 cm	A041		7	191G23-2	46					191H10-7	419288-5 / 413G23-5		
35 cm	A041	7		191G24-0	52	191H11-5					419288-5 / 413G23-5			

Cod	Lamă					Lanț						Teacă	Roată de transmisie	
	Lungime lamă	Motor	Tip	Dinți vârf circulant	Cod comandă	Număr dinți	Grosime	Pas	Tip OREGON / DOLMAR	Tip tăiere	Cod comandă (cutie carton)	Cod comandă	Tip	Cod comandă
UC011G UC012G UC013G UC014G UC015G UC016G	30 cm	A041	Vârf circulant	8	191T86-6	51	1,1 mm	.325"	80TXL	MC	191T90-5	419288-5 / 413G23-5	Roată .325" LP	191V91-5
	35 cm	A041		8	191T87-4	59					191T91-3	419288-5 / 413G23-5		
	40 cm	A041		8	191T88-2	64					191T92-1	419242-9 / 413G21-9		
	45 cm	A041		8	191X03-0	70					191X04-8	419242-9 / 413G21-9		
	30 cm	A041	Vârf circulant	7	191G15-1	46	1,1 mm	3/8"	90PX	CC	191H01-8	419288-5 / 413G23-5	Roată 3/8" LP	191V90-7
	35 cm	A041		7	191G16-9	52					191H02-6	419288-5 / 413G23-5		
	40 cm	A041		7	191G17-7	56					191H03-4	419242-9 / 413G21-9		
	30 cm	A041	Vârf circulant	7	191G23-2	46	1,3 mm	3/8"	91PX	CC	191H10-7	419288-5 / 413G23-5		
	35 cm	A041		7	191G24-0	52					191H11-5	419288-5 / 413G23-5		
	40 cm	A041		7	191G25-8	56					191H12-3	419242-9 / 413G21-9		
	45 cm	A041		7	191G26-6	62					191H13-1	419242-9 / 413G21-9		

*Accesoriu fierăstrău emondor (196315-2)

Lamă sculptură

	Cod	Denumire	Model compatibil
	1911A1-3	Lamă	-
	191G96-5	Lanț 25AP-60 dinți	-
	198259-2	Roată transmisie 1/4" 9T	DUC204, DUC254, DUC254C, DUC303, DUC353, DUC400, DUC305, DUC355, DUC405, DUC256, DUC306, DUC356, DUC406, DUC256C
	221528-7	Roată transmisie 1/4" 9T	DUC252, DUC302, DUC352, DUC252C
	191V92-3	Roată transmisie 1/4" 9T	UC002G, UC003G, UC004G, UC006G, UC007G

Piuliță





Cod	Model compatibil	Ambalare (buc./set)
XTM0000023	EY2650H, EY401MP*	1
264055-1	EA3200S, EA3202S, EA3500S, EA3502S	1
LC252145-2	EA4300F, EA5001P, EA5000P, EA6100P, EA6101P, EA7300P, EA7301P, EA7900P, EA7901P	1

* Atașament fierăstrău emondor (196315-2).

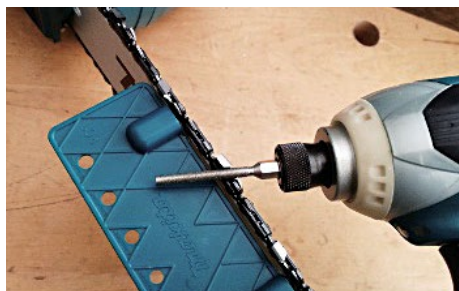
Unghiuri de ascuțire - pilă rotundă

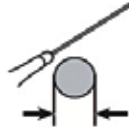

	DOLMAR			
25AP	466	4,0 mm / 5/32"	30°	0,65 mm / .025"
80TXL	-	4,0 mm / 5/32"	30°	0,65 mm / .025"
90PX	291	4,5 mm / 11/64"	30°	0,65 mm / .025"
91PX	492	4,0 mm / 5/32"	30°	0,65 mm / .025"
91VXL	196			
95VPX	484	4,8 mm / 3/16"	30°	0,65 mm / .025"
20BPX	082	4,8 mm / 3/16"	30°	0,65 mm / .025"
21BPX	086			
21LPX	686	4,8 mm / 3/16"	25°	0,65 mm / .025"
72V	496	5,5 mm / 7/32"	25°	0,65 mm / .025"
73DPX	093	5,5 mm / 7/32"	30°	0,65 mm / .025"
73LPX	099	5,5 mm / 7/32"	25°	0,65 mm / .025"
27X	103	5,5 mm / 7/32"	30°	0,75 mm / .030"

Seturi ascuțire lanț cu husă textilă

Pentru toate modelele de lanț.



Cod	Descriere	Ambalare (buc./set)
D-72154	Pilă rotundă 4,0 mm (3 buc.) / Pilă lată / Mâner (2 buc.) / Limitator de adâncime / Husă textilă	1
D-72160	Pilă rotundă 4,5 mm (3 buc.) / Pilă lată / Mâner (2 buc.) / Limitator de adâncime / Husă textilă	1
D-72176	Pilă rotundă 4,8 mm (3 buc.) / Pilă lată / Mâner (2 buc.) / Limitator de adâncime / Husă textilă	1

Pile și mânere





Pilă	Pilă și mâner	Dimensiune (mm)	Tip lanț	Ambalare (buc./set)
Cod	Cod			
953003090	195089-2 953030010	4	25AP, 91PX, 91VXL, 466, 492, 196	1
953003100	195923-6 953030020	4,5	90PX, 33SL, 34SL, 291	1
953003070	197712-5 953030030	4,8	20BPX, 21BPX, 21LPX, 95VPX, 082, 086, 686, 484	1
953003040	-	5,5	72DPX, 72LPX, 72V, 73DPX, 73LPX, 496, 093, 099	1

Pile rotunde





Cod	Descriere	Dimensiune (mm)	Ambalare (buc./set)
D-73754	Pilă rotundă, prindere 1/4" Hex	4,5	1
D-73760		4,8	1
D-73776		5,2	1
D-73782		5,5	1



Mâner, pilă și leră reglaj adâncime tăiere



	Cod	Descriere	Ambalare (buc./set)
	273646-7	Mâner	1
	953003060	Pilă lată	1
	953100090	Leră reglaj adâncime tăiere	1

Ulei pentru lanț

	Cod	Descriere	Capacitate	Ambalare (buc./set)
	195093-1 195093A1	Uleiul de lanț Makita este special conceput să adere pe lamă și lanț, astfel încât să reducă uzura.	1 L	1
	1910U0-9	Uleiul de lanț BIOTOP este sigur pentru mediu. Acesta este produs în totalitate din materiale vegetale și biodegradabile. Îndeplinește standardele stricte ale RAL UZ48 pentru compatibilitate cu mediul, lubrifiere și rezistență la îmbătrânire.	1 L	1

Ulei pentru motor

	Cod	Descriere	Capacitate	Ambalare (buc./set)
	980508620	Ulei pentru motor în 4 timpi	600 ml	1
	197008-4	Ulei pentru motor în 4 timpi 10W30	100 ml	1

	Cod	Descriere	Capacitate	Ambalare (buc./set)
	195957-9	Ulei pentru motor în 2 timpi, raport de amestec 1:50	100 ml	1
	980008607	Ulei pentru motor în 2 timpi, raport de amestec 1:50	1 L	1
	980008612	Ulei pentru motor în 2 timpi, raport de amestec 1:50, cu recipient de măsurare	1 L	1



ACCESORII PENTRU MAȘINI DE TUNS GARD VIU

Lame, apărători și tăvi colectoare

Tipul lamei

A: Lamă curbată

Formă optimă a lamei pentru tăiere fină



Lamele ascuțite:
Lama superioară -
curbată în jos
Lama inferioară -
curbată în sus



Contact doar pe
vârfurile lamei

Ramurile sunt prinse și tăiate cu ușurință



Tăiere fină



Tăiere uniformă



B: Lamă de înaltă calitate

Dinți ascuțiți pe toată lungimea
lamei pentru o tăiere curată.



Dinți cu 3 muchii
de tăiere ce oferă
o tăiere curată și
fără a deteriora
ramurile.



C: Lamă cu strat protector

Lame neelectrolizate acoperite
cu un strat de nichel ce oferă o
protecție de lungă durată.



Urme de utilizare
(după 10 ore de utilizare)



Lamă cu strat
protector

Lamă normală,
fără protecție

Model compatibil	Lungime lamă (mm)	Tip lamă	Cod lamă	Cod apărătoare	Cod tavă colectoare
------------------	-------------------	----------	----------	----------------	---------------------

Foarfece de tuns gard viu cu acumulatori

DUH551	550	C	194671-4	450489-6	194681-1
DUH651	650	C	196688-3	450490-1	194681-1
DUH483	480	C	195768-2	452684-4	195050-9
DUH523U	520	C	196167-1	452685-2	195050-9
DUH501	500	A	199098-3	458413-3	199151-5
DUH601	600	A	199099-1	458414-1	199151-5
DUH604S	600	A	191D38-1	412355-5	191D33-1
DUH751	750	A	199100-2	458415-9	199151-5
DUH502	500	B	199598-3	459120-1	199151-5
DUH602	600	B	199599-1	459121-9	199151-5
DUH506	500	C	1910H8-2	413L91-8	1910T1-0
DUH606	600	C	1910H9-0	413L92-6	1910T2-8
DUH507	500	A	1911J1-6	413L91-8	1910T1-0
DUH607	600	A	1911J2-4	413L92-6	1910T2-8
DUH752	750	B	199600-2	459122-7	199151-5
DUH754S	750	A	191D39-9	412356-3	191D34-9
UH004G	600	A	191R53-9	412911-1	191R51-3
UH005G	750	A	191R54-7	412912-9	191R52-1
UH006G	600	B	191R55-5	412911-1	191R51-3
UH007G	750	B	191R56-3	412912-9	191R52-1
UH008G	600	B	191R57-1	459121-9	191R51-3
UH009G	750	B	191R58-9	459122-7	191R52-1
UH013G	600	A	191Y03-6	413B98-4	191D33-1
UH014G	750	A	191Y05-2	413B99-2	191D34-9

Model compatibil	Lungime lamă (mm)	Tip lamă	Cod lamă	Cod apărătoare	Cod tavă colectoare
------------------	-------------------	----------	----------	----------------	---------------------

Foarfeți de tuns gard viu cu braț (cu acumulatori, benzină, atașamente multifuncțională)

DUN500W	500	A	191C14-9	458413-3	-
DUN600L	600	A	191C13-1	458414-1	-
EN420MP	250	B	198195-2	457036-4	-
EN401MP, EN410MP, EN4950H	490	B	197768-8	454279-9	-

Mașini de tuns gard viu cu motor electric

UH4861	480	C	140830-8	452684-4	195050-9
UH5570	550	C	194663-3	450489-6	194681-1
UH6570	650	C	194666-7	450490-1	194681-1
UH7580	750	C	194675-6	450490-1	194681-1

*pentru lamă fără apărătoare vârf **pentru lamă cu apărătoare vârf

Model compatibil	Lungime lamă (mm)	Articol	Cod	Descriere	Articol
------------------	-------------------	---------	-----	-----------	---------

EN401MP EN410MP	500 490	13	196969-5	Apărătoare vârf lamă
		1-11, 13 set	197763-8	Ansamblu lame
EN402MP	500	1	1912G3-7	Set lame
		2	413R17-6	Apărătoare
		Vaselină	-	Nr.2
EN422MP	250	1	1912G2-9	Set lame
		2	413P96-2	Apărătoare
		Vaselină	-	Nr.2

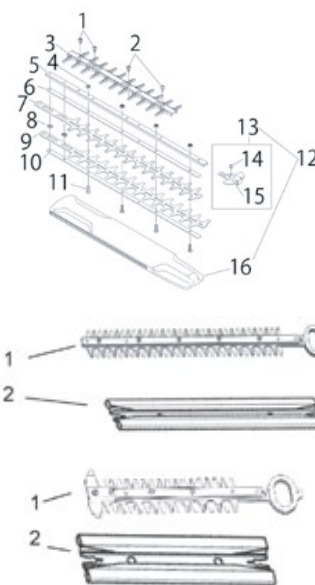

Vaselină



Descriere	Capacitate	Cod
Pentru lamele de gard viu și cuțitele multifuncționale (cultivator, valț măturător, foarfecă rotativă) (Vaselină Nr.0)	80 ml	197439-7
Pentru coase, lame de gard viu (Vaselină Nr.2)	80 ml	199450-5

Protecții lame







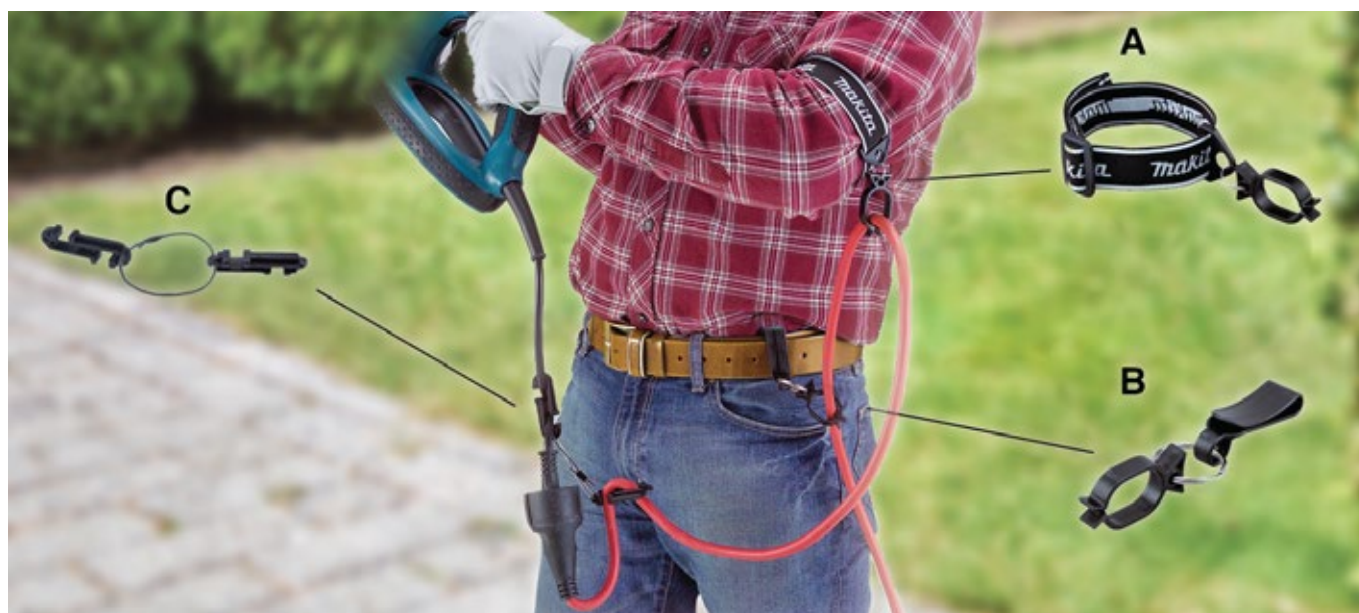

Cod	Descriere	Model compatibil	Ambalare (buc./set)
458408-6	Protecție lamă pentru foarfeci gard viu cu acumulatori	DUH501, DUH502, DUH601, DUH602, DUH751, DUH752	1
454672-7	Protecție lamă pentru foarfeci gard viu cu motor termic	EH5000W, EH6000W, EH7500W	1

Protecții extensie cordon

	Cod	Tip	Descriere	Model compatibil	Ambalare (buc./set)
	194679-8	A	Set complet de braț	UH4261, UH4570, UH4861, UH5570, UH5261, UH5580, UH6570, UH6580, UH7580	1
	194677-2	B	Set complet suport coardă	UH4261, UH4570, UH4861, UH5570, UH5261, UH5580, UH6570, UH6580, UH7580	1
	158024-1	C	Agățătoare	UH4261, UH4570, UH4861, UH5570, UH5261, UH5580, UH6570, UH6580, UH7580	1



ACCESORII PENTRU FOARFECI DE IARBĂ
Accesorii pentru tuns gazon și gard viu

	Cod	Descriere	Model compatibil	Ambalare (buc./set)
	195267-4	Cuțit tuns gazon 160 mm	DUM168, DUM604, UM600D, UM603D	1
	452055-5	Protecție cuțit tuns gazon	DUM168, DUM604, UM600D, UM603D	1
	198516-8	Atașament lung cu mâner	DUM604, UM600D, UM603D	1
	195272-1	Cuțit tuns gard viu	DUM604, UM600D, UM603D	1
	198401-5	Tavă colectoare pentru cuțit tuns gard viu	DUM604, UM600D, UM603D	1
	451816-0	Protecție pentru cuțit tuns gard viu	DUM604, UM600D, UM603D	1
	195274-7	Protecție cu apărătoare pentru cuțit tuns gard viu	DUM604, UM600D, UM603D	1



ACCESORII PENTRU FOARFECI DE TĂIAT POMI ȘI VIȚĂ DE VIE

Lame

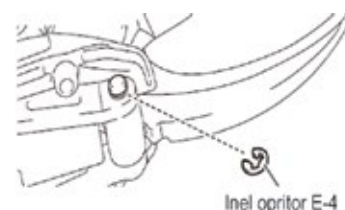

Inel opritor E-4

Cod		Tip	Model compatibil	Ambalare (buc./set)
Lamă superioară	Lamă inferioară			
197588-0*	197367-6	Standard	DUP361, DUP362	1
199168-8	199169-6	Pentru crengi groase	DUP361, DUP362	1
199314-3**	199171-9**	Pentru crengi subțiri	DUP361, DUP362	1
1911W2-5	1911W1-7	Standard	UP100D	1
1913P4-4	1913P3-6	Standard	DUP180	1

*Cu inel opritor E-4 (961011-9) **Cu șurub M3x6 (266183-8) și șurub M8 (251573-8).

Alte accesorii



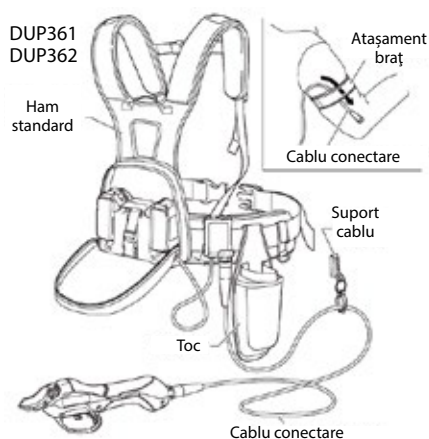

	Cod	Descriere	Model compatibil	Ambalare (buc./set)
	199311-9	Set lame pentru tăiere delicată	DUP361, DUP362	1
	794530-8	Pilă diamantată pentru ascuțit lama	DUP361, DUP362	1
	1912E4-1	Piatră pentru ascuțit lama	DUP180, UP100D	1



Cod	Descriere	Model compatibil	Ambalare (buc./set)
161377-9	Ham standard	DUP361, DUP362	1
161603-6	Ham îngust pentru vară	DUP361, DUP362	1
161379-5	Toc	DUP361, DUP362	1
166062-9	Atașament braț	DUP361, DUP362	1
154511-8	Suport cablu	DUP361, DUP362	1
661445-3	Cablu conectare	DUP361, DUP362	1
162C23-5	Toc	UP100D, DUP180	1
630E23-0	Adaptor pentru acumulator (cablu 1,4 m)	DUP180	1





ACCESORII PENTRU SUFLANTE
Accesorii pentru suflante

	Cod	Descriere	Model compatibil	Ambalare (buc./set)
	191E19-1	Kit aspirare	DUB363	1
	197235-3	Kit aspirare	BHX2500, BHX2501	1
	191B03-8	Set țevi pentru jgheaburi (2,9 m): țevă 72 (0,9 m) (3 buc.), duză (1 buc.), clemă țevă 75-90 (2 buc.), clemă țevă 85-100 (1 buc.)	DUB184 (necesită și duza adaptor 80-72), DUB362 (necesită și duza adaptor 71), DUB363 UB001C (necesită și duza adaptor 85-72.), UB001G (necesită și duza adaptor 85-72)	1
	191J13-3	Duză adaptor 71	DUB362	1
	191B21-6	Duză adaptor 80-72	DUB184	1
	191L96-5	Duză adaptor 85-72	UB001C, UB001G	1
	197888-8	Extensie duză	DUB184, DUB362, DUB363	1
	197889-6	Duză plată	DUB184, DUB362, DUB363	1
	GB00000165	Duză plată	DUB187	1
	166095-4	Centură piept	DUB184, DUB362	1
	196956-4	Centură șold	EB7660TH, EB7660WH	1

	Cod	Descriere	Model compatibil	Ambalare (buc./set)
	451752-0	Teavă	BHX2501	1
	451753-8	Duză finală (duză plată)	BHX2501	1
	123245-4	Ansamblu duză	DUB185, DUB186	1
	134182-7	Ansamblu duză	DUB182	1
	196729-5	Set duză îndoită	DUB186	1
	191G09-6	Set duză îndoită	DUB185, DUB186	1
	123241-2	Sac colector	DUB185	1



ACCESORII PENTRU MAȘINI DE SPĂLAT CU PRESIUNE
Pistoale

	Cod	Descriere	Model compatibil	Ambalare (buc./set)
	3320152	Pistol	HW102, HW111, HW112	1
	3640920	Pistol	HW121, HW132	1
	40728	Pistol	HW131	1
	41154	Pistol	HW151	1
	197842-2	Pistol	DHW080, HW1200, HW1300	1





Furtune

















Cod	Descriere	Lungime (m)	Model compatibil	Ambalare (buc./set)
3640630	Furtun presiune	5	HW102, HW111, HW112, HW121, HW132	1
3641590	Furtun presiune	5,5	HW111, HW112	1
3640960	Furtun presiune	8	HW121, HW132	1
40809	Furtun presiune	15	HW131	1
3083550	Furtun presiune	10	HW151	1
41165	Furtun curățat burlane și țevi	10	HW102, HW111, HW112, HW121, HW132, HW131, HW151	1
41167	Furtun curățat burlane și țevi	16	HW102, HW111, HW112, HW121, HW132, HW131, HW151	1
3641570	Furtun curățat burlane și țevi	8	HW132	1
41179	Extensie furtun	5	HW102	1
3640660	Extensie furtun	5,5	HW111, HW112	1
41181	Extensie furtun	8	HW112, HW121, HW132	1
41183	Extensie furtun	8	HW131, HW151	1
197837-5	Furtun curățare țevi	10	DHW080, HW1200, HW1300	1
197840-6	Furtun curățare țevi	15	DHW080, HW1200, HW1300	1
197845-6	Extensie furtun presiune	5	DHW080, HW1200, HW1300	1
197847-2	Extensie furtun presiune	8	DHW080, HW1200, HW1300	1
197850-3	Extensie furtun presiune	10	DHW080, HW1200, HW1300	1



Perii

	Cod	Descriere	Model compatibil	Ambalare (buc./set)
	3640950	Perie fixă	HW111, HW112, HW121, HW132	1
	41185	Perie fixă	HW102, HW102, HW111, HW112, HW121, HW132, HW151	1
	41187	Perie rotativă	HW102, HW111, HW112, HW121, HW132, HW131, HW151	1
	40740	Perie rotativă curățat pardoseli	HW131, HW151	1
	197864-2	Apărătoare duză ciclonică	DHW080, HW1200, HW1300	1
	197828-6	Perie fixă	DHW080, HW1200, HW1300	1
	197831-7	Perie rotativă	DHW080, HW1200, HW1300	1

Duze și accesorii

	Cod	Descriere	Model compatibil	Ambalare (buc./set)
	3320130	Extensie	HW102, HW111, HW112	1
	3640640	Lance duză reglabilă	HW102	1
	3640650	Lance duză reglabilă	HW111, HW112	1
	3640930	Lance duză reglabilă	HW121	1
	3641150	Lance duză reglabilă	HW132	1





	Cod	Descriere	Model compatibil	Ambalare (buc./set)
	40729	Lance duză reglabilă	HW131	1
	40551	Lance duză reglabilă	HW151	1
	41169	Lance Turbo	HW102, HW111, HW112	1
	41171	Lance Turbo	HW121, HW132	1
	3320120	Lance Roto Power	HW102, HW111, HW112	1
	3640940	Lance Roto Power	HW121, HW132	1
	40730	Lance Roto Power	HW131	1
	41173	Lance Roto Power	HW151	1
	3640670	Duză	HW111, HW112, HW121, HW132	1
	3640090	Vas detergent	HW102	1
	3640380	Vas detergent	HW132	1
	197822-8	Set duză reglabilă	DHW080, HW1200, HW1300	1
	197876-5	Set lance reglabilă	DHW080, HW1200, HW1300	1
	197824-4	Set duză ciclonică	DHW080, HW1200, HW1300	1
	197859-5	Lance - partea inferioară	DHW080, HW1200*, HW1300* (*pentru 110-127V)	1
	198909-9	Lance - partea inferioară	HW1200**, HW1300** (**pentru 220V-240V)	1

	Cod	Descriere	Model compatibil	Ambalare (buc./set)
	197870-7	Set extensii țevă (0,9 m / 1,3 m / 1,7 m)	DHW080, HW1200, HW1300	1
	197886-2	Duză spumare	DHW080, HW1200, HW1300	1
	197879-9	Pin curățare	DHW080, HW1200, HW1300	

Racorduri și filtre



	Cod	Descriere	Model compatibil	Ambalare (buc./set)
	3082130	Cuplă rapidă cu filtru 3/4	HW102, HW111, HW112, HW121, HW132	1
	40725	Cuplă rapidă	HW102, HW111, HW112, HW121, HW132, HW131, HW151	1
	41163	Kit absorbție apă	HW102, HW111, HW112, HW121, HW132, HW131, HW151	1
	41161	Filtru apă	HW102, HW111, HW112, HW121, HW132, HW131, HW151	1
	197867-6	Racord antirăsuire	DHW080, HW1200, HW1300	1
	197873-1	Furtun auto-aspirație	DHW080, HW1200, HW1300	1
	197853-7	Accesoriu legătură	DHW080, HW1200, HW1300	1
	197881-2	Adaptor cu filtru	DHW080, HW1200, HW1300	1
	197883-8	Adaptor îmbinare rapidă	DHW080, HW1200, HW1300	1

Accesorii pentru mașina de spălat cu presiune DHW180



	Cod	Descriere	Ambalare (buc./set)
	LX00000001	Duză spumare	1
	LX00000002	Duză unghiulară	1
	LX00000003	Perie rotundă	1
	LX00000004	Duză adaptoare recipient pet	1





Accesorii pentru roabe cu acumulatori

	Cod	Descriere	Înălțime (mm)	Dimensiune (mm)	Model compatibil	Ambalare (buc./set)
	191A01-6	Roți auxiliare DCU180	180	150x530	DCU180	1
	199008-0	Cuvă DCU180	/	/	DCU180	1
	199009-8	Platformă DCU180	/	/	DCU180	1
	191B63-0	Unitate de basculare 90°	/	/	DCU603, DCU604, DCU605	1
	191B67-2	Platformă	/	625-1.015x945-1.090	DCU603, DCU604, DCU605	1
	191B69-8	Cuvă 200 L	/	/	DCU603, DCU604, DCU605	1
	1911B3-6	Cuvă colectare 250 L	/	/	DCU603, DCU604, DCU605	1

Anvelope și roți

	Cod	Descriere	Culoare	Model compatibil	Ambalare (buc./set)
	1911K4-7	Roată de cauciuc 330 mm pentru pavaj și asfalt, cu cameră (dimensiuni: 13 x 5.00 - 6)	Negru	DCU603, DCU604, DCU605	1
	1911K5-5	Roată de cauciuc gri 330 mm pentru podea vopsită, cu cameră (dimensiuni: 13 x 5.00 - 6)	Gri	DCU603, DCU604, DCU605	1
	1911K6-3	Roată de cauciuc gri 210 mm pentru podea vopsită, cu cameră (dimensiuni: 2.00 - 4). Jantă cu rulmenți butuc.	Roțile gri lasă mai puține urme de cauciuc pe podelele vopsite în depozite și hale.	DCU603, DCU604, DCU605	1









Accesorii pentru atomizor și suflanta tip rucsac

	Cod	Descriere	Dimensiune (mm)	Ambalare (buc./set)
	198249-5	Set deflector	PM001G	1
 	196733-4	Centură de piept	PM001G, PDC1200, UB002G	1

Accesorii pentru pulverizatoare cu acumulatori

Cod	Descriere	Model compatibil	Ambalare (buc./set)
PR00000251	Duză simplă	DUS108, DUS158	1
PR00000255	Duză dublă	DUS108, DUS158	1
PR00000260	Tijă	DUS108, DUS158	1
PR00000266	Ansamblu furtun	DUS108, DUS158	1
PR00000314	Agățătoare tub	DUS108, DUS158	1
PR00000137	Cap pulverizare	US053D, DUS054	1
PR00000142	Duză	US053D, DUS054	1
PR00000145	Tijă telescopică	US053D, DUS054	1
PR00000153	Ansamblu mâner	US053D, DUS054	1
PR00000154	Ansamblu furtun	US053D; DUS054	1
PR00000162	Agățătoare	US053D; DUS054	1
PR00000176	Furtun 190 mm	US053D; DUS054	1
PR00000187	Furtun 55 mm	US053D; DUS054	1

Accesorii pentru foreza de pământ DDG460

	Cod	Descriere	Dimensiune (mm)	Ambalare (buc./set)
	E-07294	Burghiu	100 x 800	1
	E-07303	Burghiu	150 x 800	1
	E-07319	Burghiu	200 x 800	1
	E-07325	Extensie burghiu	540	1
	E-07331	Știft/siguranță	-	1
	327685-0	Adaptor tip B	-	1
	327684-2	Adaptor prindere STH	-	1
	327687-6	Adaptor prindere OLEO	-	1
	327689-2	Ax mecanism TW004G/TW005G	-	1

ACCESORII PENTRU TRANSPORT ȘI DEPOZITARE



INSERTII PLASTIC TERMOFORMAT PENTRU GAMA MAKPAC

Cod mașină	Cod inserție	Model Makpac	Cod mașină	Cod inserție	Model Makpac
4329	837803-7	1	DDF448	837916-4	2
4350	837803-7	1	DDF453	837916-4	2
4351	837803-7	1	DDF456	837916-4	2
BDF441	837916-4	2	DDF458	837916-4	2
BDF451	837916-4	2	DDF459	837916-4	2
BDF452	837916-4	2	DDF470	837916-4	2
BDF454	837916-4	2	DDF480	837916-4	2
BHP441	837916-4	2	DDF481	837916-4	2
BHP451	837916-4	2	DDF482	837916-4	2
BHP452	837916-4	2	DDF483	837670-0	2
BHP454	837916-4	2	DDF484	837916-4	2
BTP130	837670-0	2	DDF485	837916-4	2
DDA340	838040-6	2	DFS250	837805-3	2
DDA341	838040-6	2	DFS251	837805-3	2
DDA350	838040-6	2	DFS441	837805-3	2
DDA351	838040-6	2	DFS451	837805-3	2
DDF + DTD	837864-7	3	DFS452	837805-3	2
DDF083	837670-0	2	DGA450	837632-8	3
DDF343	837916-4	2	DGA452	837632-8	3
DDF446	837916-4	2	DGA504	838175-3	3

Cod mașină	Cod inserție	Model Makpac	Cod mașină	Cod inserție	Model Makpac
DGA506	838175-3	3	DTD134	837670-0	2
DGA508	838175-3	3	DTD136	837670-0	2
DHP343	837916-4	2	DTD137	837670-0	2
DHP446	837916-4	2	DTD146	837670-0	2
DHP448	837916-4	2	DTD147	837670-0	2
DHP453	837916-4	2	DTD148	837670-0	2
DHP456	837916-4	2	DTD152	837670-0	2
DHP458	837916-4	2	DTD153	837670-0	2
DHP459	837916-4	2	DTD154	837670-0	2
DHP470	837916-4	2	DTD170	837670-0	2
DHP480	837916-4	2	DTM50	837671-8	3
DHP481	837916-4	2	DTM51	837671-8	3
DHP482	837916-4	2	DTP131	837670-0	2
DHP483	837670-0	2	DTP140	837670-0	2
DHP484	837916-4	2	DTP141	837670-0	2
DHP485	837916-4	2	DTS130	837670-0	2
DHR202	837634-4	3	DTS141	837670-0	2
DHR241	837641-7	3	DTW1001	837645-9	3
DHR280	839559-8	4	DTW1002	837645-9	3
DHR281	839559-8	4	DTW181	837670-0	2
DHR282	839559-8	4	DTW250	837670-0	2
DHR283	839559-8	4	DTW251	837670-0	2
DHS680	838182-6	3	DTW281	837670-0	2
DRV150	835A34-8	3	DTW285	837670-0	2
DRV250	835A34-8	3	DTW450	837645-9	3
DJS101	837636-0	2	DTW800	837645-9	3
DJS160	837636-0	2	HS6101	837807-9	4
DJS161	837636-0	2	HS7101	837807-9	4
DJV140	837639-4	2	HS7601	838108-8	4
DJV180	837639-4	2	JV0600	837803-7	1
DJV181	837789-5	3			
DJV182	837639-4	2			
DKP180	837808-7	3			
DTD129	837670-0	2			
			Potrivit pentru	Cod inserție	Model Makpac
			4 acumulatori 18V + încărcător dublu	839205-3	3

DISPOZITIVE MOBILE DE DEPOZITARE MAKIPAC

Valize Makpac

- 4 valize de dimensiuni diferite pentru depozitarea mașinilor și accesoriilor
- Valizele sunt suprapozabile pentru a facilita transportul și a economisi spațiu.

821549-5 Makpac 1 (395x295x105 mm)
821550-0 Makpac 2 (395x295x155 mm)
821551-8 Makpac 3 (395x295x215 mm)
821552-6 Makpac 4 (395x295x315 mm)

453974-8 Clapetă din plastic



Valize termoizolatoare



198254-2 Makpac - 11 L (395x295x215 mm)



198253-4 Makpac - 18 L (395x295x315 mm)

Cărucioare

TR00000001
Cărucior pentru valize Makpac (270-565x500x725-1125 mm)

- Structură robustă din aluminiu
- Sprafață de transport pliabilă
- Curea reglabilă
- Capacitate maximă: 125 kg (pe suprafață plană), 60 kg (pe scări)



P-83886

Cărucior pentru valize Makpac (360x520x158 mm)

- Două locuri cu fixare a valizei
- Roți pivotante la 360° cu sistem de blocare
- Capacitate maximă: 100 kg



Cutii organizatoare Makpac



P-84311 Makpac 3 (395x295x215 mm)



P-84327 Makpac 3 (395x295x215 mm)



P-84333 Makpac 3 (395x295x215 mm)



P-84349 Makpac 4 (395x295x315 mm)

Adaptoare Makpac

Pentru fixarea sigură a valizelor Makpac pe aspiratorul Makita

W107418357

Pentru aspirator: VC4210



Pentru fixarea sigură a valizelor Makpac pe căruciorul Makita

198599-8

Pentru aspirator: VC2211/ VC3210/ VC3211



Cutii și căptușeli pentru accesorii



B-62066 (124x78x35 mm)
B-62072 (150x102x44 mm)
B-62088 (183x124x53 mm)
 Valiză de plastic



824564-8
 Valiză de plastic



P-83836 (395x295x145 mm)
P-83842 (395x295x250 mm)
 Valiză PVC scule



P-84137
 Cutie de depozitare Makpac 395 x 295 x 165 mm



P-84268
 Interior din spumă de memorie pentru acumulatori



P-83705
 Interior din spumă de memorie



P-83652
 Recipient interior cu cutii colorate și spumă



P-83696
 Căptușeală pentru accesorii, 3 piese cu 9 compartimente



P-83674
 Căptușeală interioară din spumă pentru accesorii



839742-7
 Recipient intern pentru acumulatori (8 x 18V LXT)

Curea de umăr

161576-3

Curea de umăr pentru valizele Makpac















Organizator Makpac



Cod	Descriere
191X80-2	Organizator Makpac cu cutii interioare
191X84-4	Organizator Makpac fără cutii interioare
191X93-3	Cutie internă tip 1 50x50 mm
191X94-1	Cutie internă tip 2 50x100 mm
191X95-9	Cutie internă tip 3 100x100 mm
191X96-7	Cutie internă tip 4 100x150 mm
191X97-5	Cutie internă tip 5 150x150 mm
191X92-5	Set 5 cutii interne tip 1-5



GENȚI ȘI ALTE SOLUȚII PENTRU TRANSPORT ȘI DEPOZITARE

Suportți și curele













	Cod	Cod înlocuitor	Descriere	Dimensiuni (L x l x H) (mm)	Greutate (kg)	Ambalare (buc./set)
	E-05094	E-15154	Suport stânga/dreapta mașini de găurit	170 x 85 x 290	0,30	1
	E-05119	E-15176	Suport stânga/dreapta mașini cu impact	155 x 75 x 235	0,13	1
	E-05125	E-15182	Suport stânga/dreapta mașini de găurit și accesorii	260 x 145 x 270	0,55	1
	E-05103	E-15160	Suport stânga/dreapta	/	/	1
	E-05147	E-15207	Suport accesorii și scule de mână (3 buzunare)	320 x 145 x 270	0,67	1
	E-05153	E-15213	Suport accesorii pentru montatori acoperiș	290 x 145 x 270	0,66	1
	E-05169	E-15229	Set curea de lucru cu 3 suportți și 5 buzunare	640 x 145 x 270	1,34	1
	E-05175	E-15235	Set complet curea de lucru și suportți	880 x 0 x 310	1,73	1
	E-05181	E-15241	Suport pentru electricieni	250 x 125 x 310	0,55	1
	E-05197	E-15257	Suport universal cu agățătoare pentru ciocan	180 x 105 x 185	0,25	1
	E-05206	E-15263	Suport cu fermoare pentru accesorii sau acumulator	175 x 105 x 185	0,24	1
	E-05212	E-15279	Suport reglabil pentru electricieni	185 x 55 x 205	0,28	1



	Cod	Cod înlocuitor	Descriere	Dimensiuni (L x l x H) (mm)	Greutate (kg)	Ambalare (buc./set)
	E-05228	E-15285	Suport reglabil pentru unelte de mână	185 x 85 x 205	0,29	1
	E-12980	/	Suport telefon	/	/	1
	E-15338	/	Suport ruletă și alte scule de mână	/	/	1
	E-15198	/	Suport accesorii și scule de mână	/	/	1
	E-05284	E-15344	Suport dălți și alte scule de mână	/	/	1
	E-05234	E-15291	Suport lateral pentru ciocan și unelte de mână	110 x 70 x 165	0,15	1
	E-05240	E-15300	Suport ciocan, secure	110 x 65 x 165	0,13	1
	E-05256	E-15316	Suport universal pentru unelte	110 x 15 x 165	0,09	1
	E-05262	E-15322	Suport pentru cuțit sau foarfecă de grădină	100 x 50 x 200	0,08	1

Curele și agățători

	Cod	Cod înlocuitor	Descriere	Dimensiuni (L x l x H) (mm)	Greutate (kg)	Ambalare (buc./set)
	E-05290	E-15350	Curea/ham de umăr Quick Release	/	/	1
	E-05309	/	Set 3 agățatori de curea	41 x 0 x 129	0,03	1
	E-05315	/	Set 6 agățatori de curea	41 x 0 x 129	0,03	1
	E-05321	E-15366	Curea de piele dublă, captușită, cu agățatori adiționale	880 x 30 x 100	0,66	1
	E-05337	/	Curea Quick Release cu agățătoare	1.550 x 0 x 50	0,25	1
	E-05343	E-15693	Curea dublă de piele cu agățătoare	1.380 x 0 x 48	0,30	1
	E-05359	/	Curea de piele neagră mărimea M	1.130 x 0 x 38	0,20	1
	E-05365	/	Curea de piele neagră mărimea L	1.330 x 0 x 38	0,23	1
	E-05371	/	Curea de piele maro mărimea M	1.130 x 0 x 38	0,20	1
	E-05387	/	Curea de piele maro mărimea L	1.330 x 0 x 38	0,23	1
	E-05393	E-15372	Bretele de umăr cu suport de telefon	520 x 23 x 410	0,47	1
	E-05402	/	Bretele de umăr Makita, mărime universală	50	0,24	1

Geți și alte soluții de depozitare

	Cod	Cod înlocuitor	Descriere	Dimensiuni (L x l x H) (mm)	Greutate (kg)	Ambalare (buc./set)
	E-05418	E-15388	Geantă cu compartimentare internă reglabilă	510 x 300 x 310	3,38	1
	E-05446	E-15419	Geantă închisă cu mâner	490 x 310 x 360	2,72	1
	E-05452	E-15425	Geantă închisă pliabilă	280 x 510 x 295	/	1
	E-05468	E-15431	Geantă închisă pliabilă	250 x 440 x 240	/	1
	E-05474	E-15447	Geantă deschisă pentru umăr sau talie	350 x 175 x 225	0,94	1
	E-05480	E-15453	Geantă deschisă cu 4 laturi	260 x 220 x 410	1,09	1
	E-05496	E-15469	Geantă semirigidă universală	520 x 250 x 270	1,77	1
	E-05505	E-15475	Geantă laptop și scule de mână	425 x 170 x 350	2,49	1
	E-05511	E-15481	Rucsac pentru unelte și laptop	390 x 230 x 490	2,56	1
	E-05555	E-15528	Rucsac roll-top orice anotimp	/	/	1
	E-05527	E-15497	Geantă de scule tip găleată	470 x 0 x 320	0,68	1
	E-15403	/	Geantă deschisă cu mâner	/	/	1

	Cod	Cod înlocuitor	Descriere	Dimensiuni (L x l x H) (mm)	Greutate (kg)	Ambalare (buc./set)
	E-05533	E-15506	Geantă pliabilă pentru organizare unelte de mână	350 x 45 x 195	0,75	1
	E-05549	E-15512	Geantă pentru fierăstraie cu lanț	900 x 270 x 260	1,72	1
	E-05561	E-15534	Geantă tip roll-top orice anotimp	320 x 320 x 600	1,30	1

Accesorii diverse pentru depozitare

	Cod	Cod înlocuitor	Descriere	Dimensiuni (L x l x H) (mm)	Greutate (kg)	Ambalare (buc./set)
	E-05583	E-15556	Suport pentru telefon	90 x 40 x 165	0,12	1
	E-05599	E-15562	Termos inox cu suport	90 x 85 x 200	0,40	1
	E-05608	E-15578	Cană termoizolantă cu suport	125 x 100 x 175	0,22	1
	E-05614	E-15584	Geantă termoizolantă pentru mâncare	330 x 180 x 210	0,45	1
	E-05620	E-15590	Geantă termoizolantă cu ham pentru umăr	330 x 200 x 230	0,87	1
	E-05636	E-15609	Vestă de lucru cu buzunare reglabile	510 x 0 x 640	0,81	1
	E-05642	E-15615	Apărătoare de genunchi textile	170 x 30 x 240	0,28	1
	E-05658	/	Apărătoare de genunchi profesionale	170 x 95 x 240	0,52	1

Alte tipuri de geți pentru depozitare

	Cod	Descriere	Pentru modelul	Dimensiuni (L x l x H) (mm)	Ambalare (buc./set)
	168467-9	Toc textil	-	-	1
	831278-2	Geantă scule DK1802	-	-	1
	199297-7	Geantă cu fermoar pentru acumulatori	-	-	1
	E-05577	Geantă/rucsac roll-top orice anotimp	-	-	1
	831271-6	Geantă textilă pentru transport	-	-	1
	831279-0	Geantă textilă tip troler	-	700 x 380 x 300	1
	E-11782	Gentă de scule ultra rezistentă	-	-	1
	E-12712	Geantă profesională textilă tip troler	-	-	1
	E-05424	Geantă de rezistență pentru scule	-	-	1
	E-05430	Geantă deschisă cu mâner	-	-	1

VALIZE ȘI GENȚI DEPOZITARE



Model mașină	Cod	Material	Model mașină	Cod	Material	Model mașină	Cod	Material
9557	823256-6	M	DGA452Z	141257-5	P	HP1630K	824811-7	P
4350CT	824809-4	P	DGA701	821717-0	P	HP331DZ	821661-1	P
4351CT	824809-4	P	DGA900Z	821717-0	P	HP332DZ	821661-1	P
HR2432	824729-2	P	DGA901	821717-0	P	HP347DWE	824981-2	P
1902	824944-8	P	DHP446RFJ	141856-3	P	HP457DWE	824981-2	P
1923H	824944-8	P	DHP456RFJ	141856-3	P	HR2470	824799-1	P
5604R	824555-9	P	DHP459Z	158597-4	P	HR2470T	824799-1	P
5903R	193196-5	P	DHP482Z	141856-3	P	HR2641	824695-3	P
6271DWE	824852-3	P	DHP483Z	141856-3	P	HR2800	824789-4	P
6281DWE	824852-3	P	DHP484Z	158597-4	P	HR2810	824789-4	P
6391DWPE	824852-3	P	DJR183Z	821586-9	P	HR2810T	824789-4	P
HR2470	824861-2	P	DJR186Z	821620-5	P	HR2811FT	824789-4	P
6918FDWDE	824852-3	P	DJR187Z	821620-5	P	HR4001C	140760-3	P
BO5030	824562-2	P	DJR360Z	821620-5	P	HR4002	824798-3	P
BO5031	824562-2	P	DJV180Z	141486-0	P	HS7101	141736-3	P
BJR181	824760-8	P	DTD152Z	141856-3	P	BGA450	824767-4	P
BTD130FZ	141205-4	P	DTD155Z	141856-3	P	BGA452	824767-4	P
DDF083Z	141856-3	P	DTW190Z	141856-3	P	JV0600K	824998-5	P
DDF446RFJ	141856-3	P	DTW250Z	141205-4	P	JV100DWE	821508-9	P
DDF456RFJ	141856-3	P	DTW251Z	141205-4	P	KP0800	824892-1	P
DDF459Z	158597-4	P	DTW450Z	141205-4	P	SG1251J	821552-6	P
DDF482Z	141856-3	P	FS2700	824890-5	P	SP6000	821552-6	P
DDF483Z	141856-3	P	6905H	P-04101	M	TD110DZ	821661-1	P
DDF484Z	158597-4	P	GA4530	823294-8	M	TD111DZ	821661-1	P
DF031DZ	821661-1	P	GA5030	823294-8	M	TD126DWE	824981-2	P
DF331DZ	821661-1	P	BDF448	143603-8	P	TD127DWE	824981-2	P
DF332DZ	821661-1	P	BDF458	143603-8	P	TW0350	824702-2	P
DF347DW	824981-2	P	GA9020	824958-7	P	TW100DWE	824781-0	P
DF457DWE	824981-2	P	HK1820	824789-4	P			
DHP451	140354-4	P	HM1101C	140562-7	P			
DHP454	140354-4	P	HM1111C	140562-7	P			
DGA450Z	141257-5	P	DHR241Z	824771-3	P			

Material: **P**: Valiză de plastic **M**: Cutie metalică

ACCESORII DIVERSE



Mânere laterale

	Cod	Descriere	Pentru modelul	Ambalare (buc./set)
	122464-9	Mâner lateral	6906	1
	122727-3	Mâner lateral	TW1000	1
	123257-7	Mâner	HP458D	1
	134890-0	Mâner lateral tip D	HM1111C, HM1101C, HR3540C, HR3541FC, HR4001C, HR4002, HR4010C, HR4011C, HR4040C, HR4501C, HR4510C, HR4511C	1
	134909-5	Mâner lateral tip D	HM1100, HM1100C, HM1200, HM1200B, HM1130, HM1130C, HM1140C, HM1211B, HM0870C, HM0871C	1
	134910-0	Mâner lateral	DP4003	1
	135209-6	Mâner lateral	HR3540C, HR3541FC, HR4001C, HR4010C, HR4011C, HR4501C, HR4510C, HR4511C	1
	135269-8	Mâner lateral tip D	HM1202C, HM1242C, HR5201C, HR5210C, HR5211C	1
	135283-4	Mâner lateral tip D	HM1214C	1
	135302-6	Mâner lateral	HR2021, HR2022, HR2432, HR2441, HR2445, HR2451, HR2452, HR2453, HR2454, HR2455	1
	135332-7	Mâner lateral	HM0870C, HM0871C	1
	135380-6	Mâner lateral	HR5201C, HR5210C, HR5211C	1
	126131-8	Mâner complet	BHP448, BHP458, DHP448, DHP458	1
	123257-7	Mâner complet	BHP448, BHP458, DHP448, DHP458	1

	Cod	Descriere	Pentru modelul	Ambalare (buc./set)
	152492-0	Mâner lateral	6300-4, 6013BR, 6300NB, 6016, DP4700	1
	152612-6	Mâner lateral	5901B	1
	153489-2	Mâner lateral	MT952, MT953, 9554NB, PW5000CH	1
	154935-8	Mâner lateral	BDF444RFE, BDF454RFE	1
	158057-6	Mâner lateral	BHR202, BHR242, BHR243, BHR261, BHR262, HP1230, HR1830, HR1830F, HR1830FT, HR2230, HR2460, HR2460F, HR2470, HR2470F, HR2470T, HR2470FT, HR2475, HR2800, HR2810, HR2810FT, HR2811FT	1
	158131-0	Mâner lateral	HM0830, HM0870C, HM0871C, HR3000C, HR3530, HR3540C, HR3541FC, HR4000C, HR4001C, HR4002, HR4010C, HR4011C, HR4030C, HR4041C, HR4500C, HR4501C, HR4510C, HR4511C, HR5001C, HR5201C, HR5210C, HR5211C	1
	158237-4	Mâner lateral	DGA504	1
	162264-5	Mâner lateral cu sistem de reducere a vibrațiilor	GA9040S	1
	194514-0	Mâner lateral cu sistem de reducere a vibrațiilor	GA5010, CA5011, GA5020, GA5021, GA5021C, GA6010, CA6011, GA6020, GA6020C, GA6021, GA6021C	1
	273404-1	Mâner lateral	6013BR-T17273404-1	1
	273495-2	Mâner lateral	LS1030, LS800DWA	1
	416256-9	Mâner circular	9227C, PC5000C	1
	416348-4	Mâner circular	9227CB	1
	419792-4	Mâner lateral	HR5210C, HR5211C	1
	XNR0000304	Mâner circular	EBH341	1

Chei pentru montare accesorii



Cod	Descriere	Dimensiune	Pentru modelul	Ambalare (buc./set)
782401-1	Cheie specială pentru montare accesorii	20 mm	PJ7000, 3901, BPJ180, DPJ180	1
197610-3	Cheie specială pentru montare accesorii	35 mm	GA9010, GA9020, GA9030, GA9040, GA7010, GA7020, GA7030, GA7040, GA5040, GA4540	1
782423-1	Cheie specială pentru montare accesorii	35 mm	GA6021, GA6021C, 9558, 9557	1



Chei tubulare





Cod	Descriere	Dimensiune	Pentru modelul	Ambalare (buc./set)
782203-5	Cheie tubulară tip T	SW9	2012NB	1
782209-3	Cheie tubulară tip T	SW9	1902, 1911B, 1923H, 4101R, 4105KB, BKP180, KP0800, KP0810, KP0810C	1
782210-8	Cheie tubulară tip T	SW17	2414NB, 4112HS, AT3624, BBC231U, BC231UD, LC1230	1

ACCESORII ȘI ECHIPAMENTE DE PROTECȚIE

Accesorii pentru transportul mașinilor și accesoriiilor

	Cod	Descriere	Ambalare (buc./set)
	197941-0	Curea transport și cârlig pentru DTW190	1
	199231-7	Cârlig de agățat pentru fierăstraie cu acumulatori	1
	346317-0	Cârlig agățător pentru mașini de înșurubat	1

Ochelari de protecție

	Cod	Descriere	Ambalare (buc./set)
	192219-6	Ochelari de protecție	1
	AL00000147	Ochelari de protecție	1

UNELTE DE MÂNĂ



Chei combinate



Cod	Descriere	Dimensiune (mm)	Ambalare (buc./set)
E-11586	Cheie combinată 8 mm	8	1
E-11592	Cheie combinată 10 mm	10	1
E-11601	Cheie combinată 12 mm	12	1
E-11617	Cheie combinată 13 mm	13	1
E-11623	Cheie combinată 14 mm	14	1
E-11639	Cheie combinată 15 mm	15	1
E-11645	Cheie combinată 16 mm	16	1
E-11651	Cheie combinată 17 mm	17	1
E-11667	Cheie combinată 18 mm	18	1
E-11673	Cheie combinată 19 mm	19	1

Seturi de unelte de mână

	Cod	Descriere	Ambalare (buc./set)
	B-65545	Set 5 chei fixe	1
	B-65551	Set 5 chei inelare duble cotite	1

Ciocan

Ciocan universal pentru baterea și scoaterea cuielor. Design turnat dintr-o bucată pentru o rezistență mai mare.



Cod	Descriere	Lungime (mm)	Greutate (kg)	Ambalare (buc./set)
B-65779	Ciocan dulgherie	250	0,57	1

Chei hexagonale - Imbus

	Cod	Descriere	Dimensiuni	Ambalare (buc./set)
	B-65894	Set 9 imbusuri	1.5, 2, 2.5, 3, 4, 5, 6, 8, 10	1

Seturi de accesorii cu chei tubulare

Macanism clichet cu 84 de dinți cu unghi de 4,3°.





	Cod	Descriere	Biți și chei tubulare (mm)	Accesorii	Ambalare (buc./set)
	B-65573	Trusă 23 chei tubulare 3/8	3/8" SQ: 8, 9, 10, 11, 12, 13, 14, 15, 16, 17, 18, 19, 20 3/8" SQ atașament central: 8, 10, 13, 16, 17, 19	Antrenor cu clichet 84 dinți, adaptor 1/2", cheie tip T, extensie: 75 mm, 150 mm	1
	E-10899	Set scule de mână, 76 piese	-	-	1
	E-08458	Set scule de mână, 87 piese	-	-	1
	E-08713	Set scule de mână Makpac 120 piese	-	-	1
	E-06616	Set 120 tubulare, biți și chei de mână	-	-	1
	E-10883	Set scule reparații casnice, 221 piese	-	-	1

Chei tubulare



Cod	Dimensiune cheie	Lungime totală (mm)	Ambalare (buc./set)
B-65648	10	32	1
B-65654	11	32	1
B-65660	12	32	1
B-65676	13	32	1
B-65682	14	32	1
B-65698	15	32	1
B-65707	16	32	1
B-65713	17	32	1
B-65729	18	32	1
B-65735	19	32	1

Accesorii chei tubulare

	Cod	Descriere	Lungime (mm)	Ambalare (buc./set)
	B-65844	Adaptor 1/4"	/	1
	B-65850	Adaptor 3/8"	/	1
	B-65632	Extensie tubulară 75 mm	75	1
	B-65610	Cheie cu clichet	205	1
	B-65626	Cheie cu clichet reglabilă	305	1
	E-11570	Cheie cu clichet 1/2"	-	1
	E-11558	Cheie cu clichet 1/4"	-	1
	E-11564	Cheie cu clichet 3/8"	-	1

Șurubelnițe plate



Cod	Descriere	Lungime (mm)	Tip vârf	Tip	Ambalare (buc./set)
B-66020	Șurubelniță	100	SL4	magnetic	1
B-66036	Șurubelniță	100	SL5.5	magnetic	1
B-66042	Șurubelniță	125	SL6.5	magnetic	1
B-66058	Șurubelniță	150	SL8	magnetic	1

Șurubelnițe Torx







Cod	Descriere	Lungime (mm)	Tip vârf	Tip	Ambalare (buc./set)
B-65975	Șurubelniță	100	T10	magnetic	1
B-65981	Șurubelniță	100	T15	magnetic	1
B-65997	Șurubelniță	100	T20	magnetic	1
B-66008	Șurubelniță	100	T25	magnetic	1
B-66014	Șurubelniță	100	T30	magnetic	1

Șurubelnițe în cruce





Cod	Descriere	Lungime (mm)	Tip vârf	Tip	Ambalare (buc./set)
B-65903	Șurubelniță	100	PH1	magnetic	1
B-66064	Șurubelniță impact	75	PH1	magnetic	1
B-65919	Șurubelniță	100	PH2	magnetic	1
B-66070	Șurubelniță impact	100	PH2	magnetic	1
B-65931	Șurubelniță	150	PH3	magnetic	1
B-66086	Șurubelniță impact	150	PH3	magnetic	1
B-65947	Șurubelniță	80	PZ1	magnetic	1
B-66092	Șurubelniță impact	75	PZ1	magnetic	1
B-65953	Șurubelniță	100	PZ2	magnetic	1
B-66101	Șurubelniță impact	100	PZ2	magnetic	1
B-65969	Șurubelniță	150	PZ3	magnetic	1
B-66117	Șurubelniță impact	150	PZ3	magnetic	1

Rulete

	Cod	Descriere	Ambalare (buc./set)
	B-57130	Ruletă 3,5 m x 16 mm	1
	B-57152	Ruletă 7,5 m x 25 mm	1
	B-57168	Ruletă 10 m x 25 mm	1
	B-57174	Ruletă 7,5 m x 25 mm	1

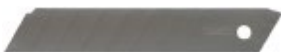
Cuttere

	Cod	Descriere	Ambalare (buc./set)
	B-65517	Set lame trapezoidale cutter pliabil	10/1
	D-74734	Set lame SNAP-OF	10/1
	B-65785	Cutter cu lamă retractabilă	1
	D-58855	Cutter cu lamă retractabilă segmentată	1

Clești foarfecă de tablă

Potrivii pentru foi de tablă galvanizată și profil U. Mâner cauciucat ce previne alunecarea. Tăiș ascuțit din aliaj crom molibden pentru o rezistență mai bună.

	Cod	Descriere	Potrivit pentru	Capacitate de tăiere (laminat / oțel inoxidabil)	Ambalare (buc./set)
	B-65822	Clește foarfecă tablă scurt	pentru tăierea plăcilor groase	16 ga (1,63 mm) / 18 ga (1,22 mm)	1

Instrumente pentru filetare

	Cod	Descriere	Ambalare (buc./set)
	B-65872	Suport tarot	1
	B-65888	Adaptor filieră	1



Makita România S.R.L.

Șoseaua Gării nr. 6, Brănești / Ilfov

Tel: (0040)-21-569.80.61



www.makita.ro



Makita Romania

Informațiile cuprinse în acest catalog au caracter general și pot conține erori de procesare sau datorate unor modificări ulterioare ale producătorului. Makita România își rezervă dreptul de a aduce modificări prezentului catalog și nu își asumă răspunderea pentru eventualele erori de tipar.